

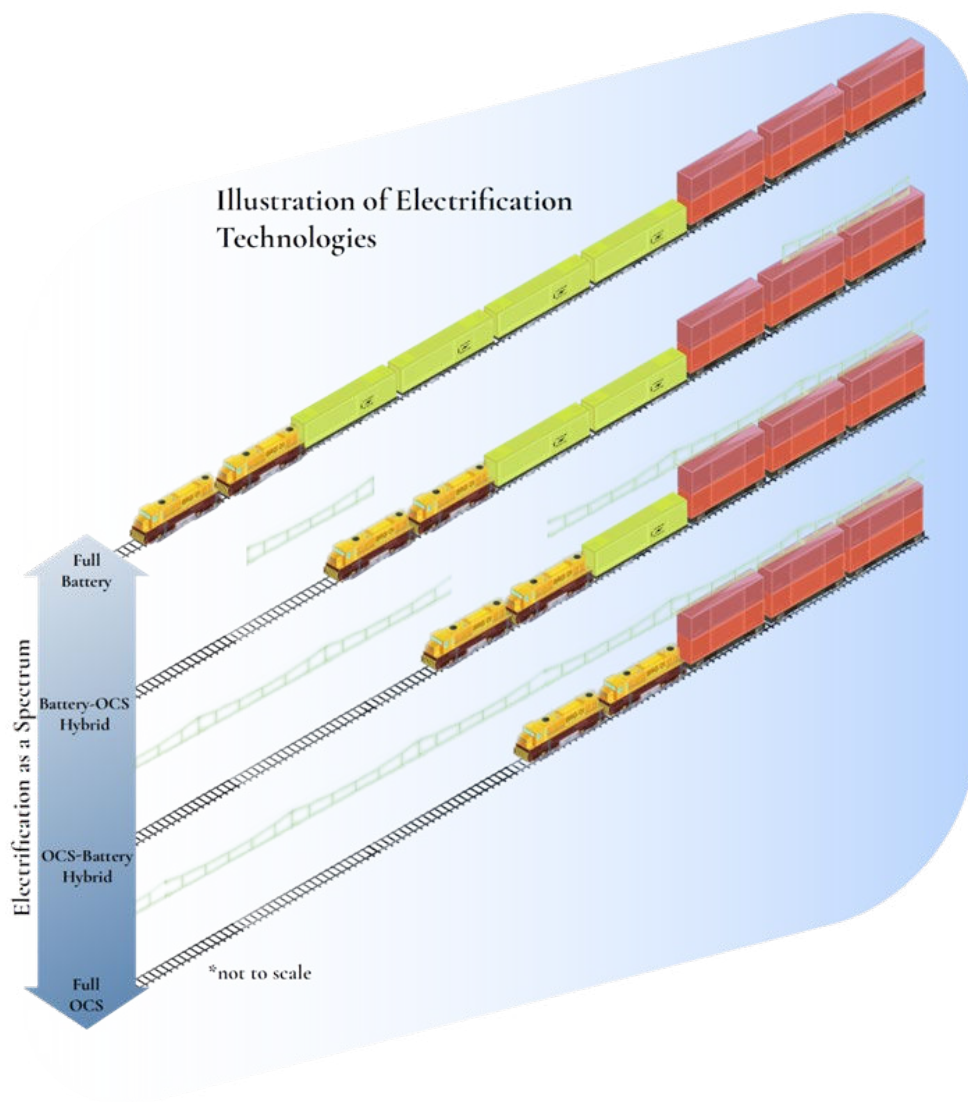

Cost and Benefit Risk Framework for Modern Railway Electrification Options



NOTICE

This document is disseminated under the sponsorship of the Department of Transportation in the interest of information exchange. The United States Government assumes no liability for its contents or use thereof. Any opinions, findings and conclusions, or recommendations expressed in this material do not necessarily reflect the views or policies of the United States Government, nor does mention of trade names, commercial products, or organizations imply endorsement by the United States Government. The United States Government assumes no liability for the content or use of the material contained in this document.

NOTICE

The United States Government does not endorse products or manufacturers. Trade or manufacturers' names appear herein solely because they are considered essential to the objective of this report.

REPORT DOCUMENTATION PAGE

Form Approved
OMB No. 0704-0188

The public reporting burden for this collection of information is estimated to average 1 hour per response, including the time for reviewing instructions, searching existing data sources, gathering and maintaining the data needed, and completing and reviewing the collection of information. Send comments regarding this burden estimate or any other aspect of this collection of information, including suggestions for reducing the burden, to Department of Defense, Washington Headquarters Services, Directorate for Information Operations and Reports (0704-0188), 1215 Jefferson Davis Highway, Suite 1204, Arlington, VA 22202-4302. Respondents should be aware that notwithstanding any other provision of law, no person shall be subject to any penalty for failing to comply with a collection of information if it does not display a currently valid OMB control number.
PLEASE DO NOT RETURN YOUR FORM TO THE ABOVE ADDRESS.

1. REPORT DATE (DD-MM-YYYY) January 2025	2. REPORT TYPE Technical Report	1. REPORT DATE (DD-MM-YYYY) 30 September 2024
--	---	---

4. TITLE AND SUBTITLE Cost and Benefit Risk Framework for Modern Railway Electrification Options	5a. CONTRACT NUMBER 693JJ6-23-C-000021
	5b. GRANT NUMBER
	5c. PROGRAM ELEMENT NUMBER

6. AUTHOR(S) C. Tyler Dick – ORCID: 0000-0002-2527-1320 Rydell D. Walthall – ORCID: 0000-0003-2699-3285 Michael E. Iden – ORCID: 0009-0001-4919-1691 James R. Blaze	5d. PROJECT NUMBER
	5e. TASK NUMBER
	5f. WORK UNIT NUMBER

7. PERFORMING ORGANIZATION NAME(S) AND ADDRESS(ES) The University of Texas at Austin, 110 Inner Campus Drive, Austin, TX 78712 Tier 5 Locomotive LLC James R. Blaze – Railroad Economist	8. PERFORMING ORGANIZATION REPORT NUMBER DOT/FRA/ORD-25/01
--	--

9. SPONSORING/MONITORING AGENCY NAME(S) AND ADDRESS(ES) U.S. Department of Transportation Federal Railroad Administration Office of Railroad Policy and Development Office of Research, Development and Technology Washington, DC 20590	10. SPONSOR/MONITOR'S ACRONYM(S)
	11. SPONSOR/MONITOR'S REPORT NUMBER(S)

12. DISTRIBUTION/AVAILABILITY STATEMENT
This document is available to the public through the FRA [website](#).

13. SUPPLEMENTARY NOTES
COR: Melissa Shurland

14. ABSTRACT
The Federal Railroad Administration (FRA) contracted a research team from The University of Texas at Austin in 2023 to develop a framework for evaluating the updated costs and benefits of freight railway electrification considering traditional and modern innovative methods. The team reviewed past and current electrification studies and identified technologies and strategic operation and implementation approaches to improve benefits and reduce cost and risk. The “Cost, Uncertainty, and Risk of Railway Electrification with New Technologies” (CURRENT) model was developed as a risk-based economic analysis framework to aid railroads in evaluating electrification investments, and inform further supplier research and development.

15. SUBJECT TERMS
Freight railway electrification, electric locomotives, battery electric locomotives, overhead catenary system, dual-mode locomotives, economics, BEL, OCS

16. SECURITY CLASSIFICATION OF:			17. LIMITATION OF ABSTRACT	18. NUMBER OF PAGES 200	19a. NAME OF RESPONSIBLE PERSON
a. REPORT	b. ABSTRACT	c. THIS PAGE			19b. TELEPHONE NUMBER (Include area code)

METRIC/ENGLISH CONVERSION FACTORS

ENGLISH TO METRIC

LENGTH (APPROXIMATE)

1 inch (in)	=	2.5 centimeters (cm)
1 foot (ft)	=	30 centimeters (cm)
1 yard (yd)	=	0.9 meter (m)
1 mile (mi)	=	1.6 kilometers (km)

AREA (APPROXIMATE)

1 square inch (sq in, in ²)	=	6.5 square centimeters (cm ²)
1 square foot (sq ft, ft ²)	=	0.09 square meter (m ²)
1 square yard (sq yd, yd ²)	=	0.8 square meter (m ²)
1 square mile (sq mi, mi ²)	=	2.6 square kilometers (km ²)
1 acre	=	0.4 hectare (he) = 4,000 square meters (m ²)

MASS - WEIGHT (APPROXIMATE)

1 ounce (oz)	=	28 grams (gm)
1 pound (lb)	=	0.45 kilogram (kg)
1 short ton = 2,000 pounds (lb)	=	0.9 tonne (t)

VOLUME (APPROXIMATE)

1 teaspoon (tsp)	=	5 milliliters (ml)
1 tablespoon (tbsp)	=	15 milliliters (ml)
1 fluid ounce (fl oz)	=	30 milliliters (ml)
1 cup (c)	=	0.24 liter (l)
1 pint (pt)	=	0.47 liter (l)
1 quart (qt)	=	0.96 liter (l)
1 gallon (gal)	=	3.8 liters (l)
1 cubic foot (cu ft, ft ³)	=	0.03 cubic meter (m ³)
1 cubic yard (cu yd, yd ³)	=	0.76 cubic meter (m ³)

TEMPERATURE (EXACT)

$$[(x-32)(5/9)]\text{ }^\circ\text{F} = y\text{ }^\circ\text{C}$$

METRIC TO ENGLISH

LENGTH (APPROXIMATE)

1 millimeter (mm)	=	0.04 inch (in)
1 centimeter (cm)	=	0.4 inch (in)
1 meter (m)	=	3.3 feet (ft)
1 meter (m)	=	1.1 yards (yd)
1 kilometer (km)	=	0.6 mile (mi)

AREA (APPROXIMATE)

1 square centimeter (cm ²)	=	0.16 square inch (sq in, in ²)
1 square meter (m ²)	=	1.2 square yards (sq yd, yd ²)
1 square kilometer (km ²)	=	0.4 square mile (sq mi, mi ²)
10,000 square meters (m ²)	=	1 hectare (ha) = 2.5 acres

MASS - WEIGHT (APPROXIMATE)

1 gram (gm)	=	0.036 ounce (oz)
1 kilogram (kg)	=	2.2 pounds (lb)
1 tonne (t)	=	1,000 kilograms (kg) = 1.1 short tons

VOLUME (APPROXIMATE)

1 milliliter (ml)	=	0.03 fluid ounce (fl oz)
1 liter (l)	=	2.1 pints (pt)
1 liter (l)	=	1.06 quarts (qt)
1 liter (l)	=	0.26 gallon (gal)
1 cubic meter (m ³)	=	36 cubic feet (cu ft, ft ³)
1 cubic meter (m ³)	=	1.3 cubic yards (cu yd, yd ³)

TEMPERATURE (EXACT)

$$[(9/5)y + 32]\text{ }^\circ\text{C} = x\text{ }^\circ\text{F}$$

QUICK INCH - CENTIMETER LENGTH CONVERSION

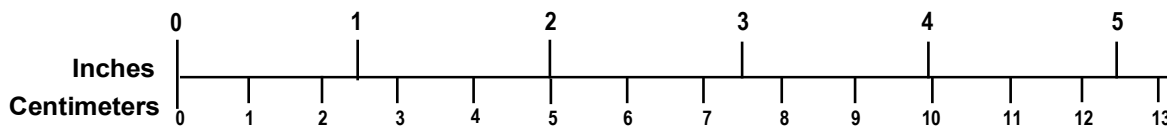

QUICK FAHRENHEIT - CELSIUS TEMPERATURE CONVERSION

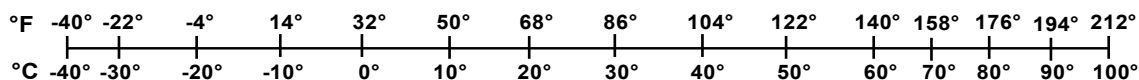

For more exact and or other conversion factors, see NIST Miscellaneous Publication 286, Units of Weights and Measures. Price \$2.50 SD Catalog No. C13 10286

Updated 6/17/98

Acknowledgements

The project team acknowledges the important contributions of the members of the project Industry Advisory Panel:

- Richard Cogswell, Federal Railroad Administration (FRA)
- Corey Davis, CSX Transportation
- Steve Griffith, National Electrical Manufacturers Association (NEMA)
- James Hoecker, Husch Blackwell
- Devin Sprinkle, Association of American Railroads (AAR)
- Lou Thompson, Independent Consultant

The project team also acknowledges the assistance of John Signor of the Southern Pacific Technical & Historical Society (SPT&HS) for granting access to historical railroad electrification studies and associated internal railroad communications located in the SPT&HS archives in Dunsmuir, California, and Bill Schafer for sharing historical electrification studies and communications from the Southern Railway archives in Chattanooga, Tennessee.

Contents

Executive Summary	1
1. Introduction.....	4
1.1 Background.....	4
1.2 Objectives	5
1.3 Overall Approach	5
1.4 Scope	6
1.5 Organization of the Report	7
2. Review of Past Studies	8
2.1 Southern Pacific (1964-1974).....	10
2.2 TVA with the Southern and L&N Railways (1978-1982)	15
2.3 Conrail (1979-1981).....	19
2.4 BC Rail Tumbler Ridge Subdivision (1981-1983)	21
2.5 Union Pacific (1980).....	23
2.6 Federal Railroad Administration (1983)	29
2.7 Other Notable Studies.....	35
3. Commonalities Between Past Studies	39
3.1 Change in Environmental Focus	39
3.2 Network Effects	39
3.3 Room for Partnerships.....	40
3.4 Competing Investment with Mergers.....	41
3.5 Economics of Traffic Projections.....	41
4. Overview of Modern Studies	43
4.1 SCRRRA LA Basin Electrification Study (1992)	43
4.2 California Air Resources Board Study (2016).....	50
4.3 Intermittent Electrification Studies from the United Kingdom	53
4.4 Modern Commuter Rail Electrification Studies	56
5. Key Barriers to Freight Rail Electrification.....	62
5.1 Economic Barriers.....	62
5.2 Technical Challenges	64
5.3 Institutional Obstacles	67
5.4 Summary.....	68
6. Methods to Streamline Catenary Construction	69
6.1 OCS Electrical Efficiency Improvements	69
6.2 OCS Design and Construction Improvements.....	73
6.3 Alternatives to OCS.....	77
6.4 Estimated Cost Savings Summary	83
6.5 Technological and Commercial Readiness.....	84
7. Locomotive Technologies.....	88
7.1 Current Diesel-electric Locomotives.....	88
7.2 New Electric Locomotives	88

7.3	Battery-electric Locomotives.....	92
7.4	Dual-mode Locomotives	96
7.5	Comparison of Alternative Locomotive Technologies	116
8.	Intermittent Electrification.....	125
8.1	Concept of Electrification as a Spectrum	125
8.2	Technical Challenges	127
8.3	Potential Economic Advantages	128
9.	Implementation Strategies	130
9.1	Private-public Partnerships to Capture Social Benefits of Electrification	130
9.2	Right-of-Way Sharing Agreements with Electric Utility Providers	133
10.	Mapping Possible Solutions to Economic Barriers.....	137
10.1	OCS Infrastructure Solutions.....	137
10.2	Motive Power Solutions	138
10.3	Intermittent Electrification and Implementation Strategy Solutions	138
11.	Costs, Uncertainties, and Risks of Rail Electrification with New Technologies (CURRENT) Model.....	140
11.1	Train Performance Function	140
11.2	Economic Model	142
11.3	Risk Analysis Framework.....	149
12.	Case Study 1: Mine-to-Port Railway.....	153
12.1	Scenario 1: Conventional Electrification with OCS	154
12.2	Scenario 2: Intermittent Electrification with Short OCS Gaps.....	156
12.3	Scenario 3: Electrification via Batteries.....	157
12.4	Scenario 4: Intermittent Electrification via Batteries and Short OCS Recharging Segments.....	160
12.5	Case Study Conclusions	162
13.	Case Study 2: Double-Track Mainline Corridor.....	164
13.1	Scenario 1: Conventional Electrification with OCS	165
13.2	Scenario 2: Intermittent Electrification with Short OCS Gaps.....	168
13.3	Scenario 3: Intermittent Electrification with Batteries and Short OCS Recharging Sections.....	168
13.4	Scenario 4: Progressive Electrification with Dual-mode Locomotives	172
13.5	Case Study Conclusions	175
14.	Conclusion	177
15.	References.....	179
	Abbreviations and Acronyms	184

Illustrations

Figure 1. Distribution of Publication Years for Studies Analyzed in Task I of the Project.....	8
Figure 2. Map of RTOs and ISOs Across the Country	10
Figure 3. Extent of the Base Case Electrified Route in the 1980 UP Study	24
Figure 4. Planned Construction Timeline for the UP Electrification.....	25
Figure 5. Concept Sketch of the Wayside Energy Storage System (WESS)	26
Figure 6. UP Study Sensitivity Analysis.....	27
Figure 7. Typical Catenary Cross-section from UP’s Electrification Study	29
Figure 8. Hypothetical 29,000-mile Rail Network Analyzed in the 1983 TSC Study for FRA....	30
Figure 9. Sensitivity of Electrification Rate of Return to REAM Input Factors	33
Figure 10. New Energy Generation and Transmission across Four NREL Scenarios (Denholm, Brown, & Cole, 2022)	40
Figure 11. Historical Real Diesel Prices	43
Figure 12. Proposed SCRRRA Electrification Capital Outlays With and Without Capital Constraints	48
Figure 13. Sensitivity Analysis Range of BCRs for GO Transit Electrification Scenarios.....	61
Figure 14. Simplified Electric Diagram for an Autotransformer System Considered in the 1992 SCRRRA Rail Electrification Study.....	71
Figure 15. Train Running with OCS Along a Dual-electrified Rail Line with Third Rail	78
Figure 16. Typical Third Rail Layout with Coverboard (1), Power Rail (2), Insulator (3), Sleeper (4), and Tracks (5) (Fong, 2020).....	80
Figure 17. Visible Arcing Between the Lead Rail Vehicle’s Shoe and One of the Energized Rails on the London Underground (SPSmiler, 2005)	81
Figure 18. Conceptual Conversion of Existing AC Traction Diesel-Electric Locomotive to Electric Operation Via OCS	90
Figure 19. Conceptual Conversion of Existing AC Traction Diesel-Electric Locomotive to BEL	96
Figure 20. Conventional Electrification (top) Versus Dual-mode Operations (bottom)	98
Figure 21. Exchange Point Operations on Paired “Herringbone” Exchange Tracks.....	98
Figure 22. Locomotive Exchange Point Conceptual Design Schematic.....	99
Figure 23. Example of Distributed Power Operations for a Train is Moving from Left to Right.	99
Figure 24. Simplified DML System Diagram (Cook & Lawson, 1981).....	100
Figure 25. Equipment Layout for the 50 kV SD40-2 DML	101
Figure 26. Components of the SD40-2 As-built.....	102

Figure 27. Comparison of the Estimated Performance of the SD40-2 DML with a Modern 4,400 hp Diesel-electric Locomotive with AC Traction Motors.....	102
Figure 28. Timeline for Prototyping of the SD40-2 DML in the 1981 FRA Dual-mode Locomotive Research Project.....	103
Figure 29. Comparison of the Internal Equipment for an ALP45DP and an ES44AH	104
Figure 30. Tractive Effort Curve for the ALP45DP and Typical Line-haul Freight Locomotive	105
Figure 31. NJ Transit ALP45DP DML Development Timeline.....	106
Figure 32. ALC-42E Dual-mode Locomotive and APV Coach.....	107
Figure 33. DC Link of an AC Diesel-electric Locomotive	109
Figure 34. DC Link of an AC Electric Locomotive.....	109
Figure 35. Diagram of the Primary Components in a Modern AC Diesel-electric Locomotive (top) and How They Would Be Shifted (bottom) to Convert the Locomotive to Accept Energy from an OCS or from a Fuel Tender.....	110
Figure 36. DFT Connected to Two Converted DMLs – the DMLs can Accept Chemical Energy from the Tender or Electrical Energy from an OCS	111
Figure 37. Side-view of Swedish IORE Electric Freight Locomotive and Close-up of its Low-profile High-voltage Transformer	112
Figure 38. Alternate Configuration for a DML with DFT Repositioning the Dynamic Brake Compartment to Allow Room for Pantographs without Increasing Locomotive Height....	113
Figure 39. Primary Components of a Conventional AC Diesel-electric Locomotive (top) and a Converted DML Using an EPT.....	114
Figure 40. Relationship of the DML with EPT (i.e, eTender) to Electrification Schemes with Partial OCS	115
Figure 41. Efficiency Comparison of Various Locomotive Technologies	116
Figure 42. Summary of Alternative Locomotive Technology TRL and CRI	118
Figure 43. Proposed Timeline for a Future Dual-mode Freight Locomotive Research Project..	124
Figure 44. Illustration of the Spectrum of Intermittent Electrification from Fully Battery-powered Electric Trains to Fully OCS-powered Electric Trains	127
Figure 45. Sensitivity Analysis of Electric Operations During the Ongoing Construction Period for a Simulated Electrification of the BNSF TransCon.....	129
Figure 46. Map of Regional Grid Electricity CO ₂ Intensity Across the US from FRA’s Locomotive Emissions Comparison Tool (LECT).....	132
Figure 47. Latitudinal Transmission Line Next to a Norfolk Southern (formerly Conrail) Rail Line Near Lake Calumet in Chicago, IL. Note the Proximity of the Relatively Thin Power Pylon to the Railroad Tracks	134

Figure 48. Longitudinal Transmission Line Along the Chicago South Shore and South Bend Railroad Parallel to the Indiana Toll Road	134
Figure 49. Diagram of the Excess ROW on Either Side of an Active Railroad Track.....	136
Figure 50. Illustration of How the Three Primary Components of the CURRENT Model Connect to One Another.....	140
Figure 51. Example Calculations of the Thermal Efficiency of Different Locomotive Technologies	141
Figure 52. An Example of CURRENT’s Capital Construction Costs by Year.....	143
Figure 53. US EPA eGRID Subregions – CURRENT Can Apply Different Electricity Emissions Factors for Each Subregion.....	145
Figure 54. Sample Output of Net CO2 Emissions from CURRENT.....	146
Figure 55. Sample pdf for 5,000 Simulations of CURRENT.....	150
Figure 56. Sample cdf for 5,000 Simulations of CURRENT	151
Figure 57. Example Sensitivity Analysis from CURRENT – By Utilizing the Argo Plugin, CURRENT Can Provide a Spider Chart for Specific Parameters of Interest.....	152
Figure 58. Elevation Profile of the Taconite Loop from Superior, WI, (km 0) to Hibbing, MN (km 169).....	153
Figure 59. Private and Public Net Cash Flows for Conventional OCS on Taconite Loop.....	155
Figure 60. Risk Analysis Results of the Conventional Electrification Scenario from the Private Perspective and Public Perspective	156
Figure 61. Battery State of Charge Versus Distance for a Fully Battery-powered Journey Unladen from the Port to the Mine.....	158
Figure 62. Battery State of charge Versus Distance for a Fully Battery-powered Journey Laden from the Mine to the Port.....	158
Figure 63. Overlay of the Train’s State of Charge Across a Full Loop Without Any Recharging Taking Place at the Mine	159
Figure 64. Distribution of the Private Rate of Return for Scenario 4 of the Mine-to-port Study, Analyzing Short Recharging Segments Along the Corridor	161
Figure 65. Distribution of the Public Rate of Return for Scenario 4 of the Mine-to-port Study, Analyzing Short Recharging Segments Along the Corridor	161
Figure 66. Summary of the Public and Private Rates of Return for the Four Scenarios in the Mine-to-port Case Study	162
Figure 67. Because Project Costs are Upfront and Benefits Continue Into the Future, the Rate of Return Increases Asymptotically as the Time Horizon for the Analysis Increases Because Fewer Project Benefits Are Truncated	163
Figure 68. Elevation Profile of the Mainline Corridor Analyzed in Case Study 2 – The Route Rises Just Over One Kilometer from Kansas City, KS, to Clovis, NM.....	164

Figure 69. Capital Costs by Year for the Conventional Electrification of the Mainline Corridor – CURRENT Predicts That Construction of the OCS Will Take Slightly Over Four Years.	165
Figure 70. Project Cash Flows for Conventional Electrification of the Mainline Corridor.....	166
Figure 71. Distribution of the Private Rate of Return for Conventional Electrification of the Mainline Corridor.....	167
Figure 72. Approximate SOC for an Eastbound Intermodal Train Along the Corridor with 30 Percent OCS Coverage and 24 MW Battery Charging Capacity.....	169
Figure 73. SOC for Eastbound Intermodal Trains Assuming Different Levels of OCS Coverage and Different Levels of Maximum Power in the OCS.....	170
Figure 74. Distribution of the Private Benefits with En Route Recharging.....	172
Figure 75. Distribution of the Public Rate of Return with En Route Recharging.....	172
Figure 76. Comparison of the Rate of Return from Each Perspective With and Without Progressive Electrification.....	174
Figure 77. Distribution of Private Rate of Return for Progressive Electrification with Short OCS Gaps Using DMLs.....	174
Figure 78. Distribution of Public Rate of Return for Progressive Electrification with Short OCS Gaps Using DMLs.....	175
Figure 79. Summary of the Public and Private Rates of Return for the Four Scenarios Analyzed Within the Mainline Corridor Case Study.....	176

Tables

Table 1. Summary of SP Electrification Studies	14
Table 2. SR and L&N’s Cincinnati – Atlanta Mainlines	16
Table 3. Tonnage Hauled along the SR Route (MGT)	18
Table 4. Conrail’s Planned Investment Costs for Electrification from 1980-2010	20
Table 5. UP Electrification Analysis Segment Summary	25
Table 6. Break-down of OCS Costs Per Unit Track Length for the UP Electrification Study	25
Table 7. Qualitative Risk Assessment in UP’s Electrification Study	28
Table 8. Projected Emissions from the SCRRA 1992 Study and Calculated Emissions Reductions to Reach 90 Percent Reduction Target	45
Table 9. Crossing Bridge Interventions in the SCRRA Study	47
Table 10. Summary of SCRRA Project Costs	47
Table 11. SCRRA Electric Locomotive Costs	49
Table 12. Train Delay Cost Factors	52
Table 13. Simulated 8-car Passenger Trains Across the GWML	54
Table 14. Simulated Intermittent Electrification Passenger Train Performance Versus Diesel-Electric Operations Across the GWML	54
Table 15. Scottish Borders Railways Full and Discontinuous Electrification CAPEX	56
Table 16. Scottish Borders Railway OCS construction Costs Per Route Distance and Track Distance	56
Table 17. Estimated Caltrain Electrification Infrastructure Costs (Excluding EMUs)	59
Table 18. Crossing Bridge Interventions in the SCRRA Study	72
Table 19. Technology Readiness Level (TRL) Definitions and Descriptions	85
Table 20. Commercial Readiness Index (CRI) Definitions and Descriptions	86
Table 21. TRL Rankings for Rail Electrification Technologies	86
Table 22. US and European Train Characteristics (Furtado, 2013)	89
Table 23. Components of Existing Diesel-Electric and Converted Electric Locomotive	91
Table 24. Weight of Removed or Added Components Involved in the Theoretical Conversion of a Wabtec/GE AC4400 Freight Locomotive into a DML	111
Table 25. Direct Comparison of the Two Proposed DML Conversion Concepts	115
Table 26. Alternative Locomotive Technology SWOT Analysis	121
Table 27. 2024 Damage Costs for Emissions Per Tonne from the US DOT Cost-benefit Analysis Guidance	130
Table 28. EPA Line-haul Emission Factors (g/bhp-hr)	131

Table 29. Estimated Social Cost of Emissions for One Hour of Locomotive Operations at Maximum Power, 3300 kW (4400 hp).....	132
Table 30. Potential Impact of Identified Infrastructure, Motive Power, and Implementation Solutions on Economic Barriers to Freight Rail Electrification	137
Table 31. Cost Breakdown for the OCS Along the Mine-to-port Corridor	154
Table 32. Mine-to-Port Case Study – Conventional Electrification Results.....	155
Table 33. Mine-to-Port Case Study – Results of OCS with Short Gaps.....	157
Table 34. Mine-to-Port Case Study – Battery Electrification Results	159
Table 35. Mine-to-Port Case Study – Results of battery with short OCS segments	160
Table 36. Trains Modeled Along the Mainline Rail Corridor.....	164
Table 37. Subtotals of the Conventional Electrification OCS Cost for the Mainline Corridor Case Study.....	165
Table 38. Mainline Case Study – Conventional Electrification Results.....	167
Table 39. Mainline Case Study – Results of Intermittent Electrification with Short OCS Gaps	168
Table 40. OCS Subtotals for Intermittent Electrification with Short Recharging Segments	171
Table 41. Mainline Case Study – Results of Intermittent Electrification with Batteries and Short Recharging Sections	171
Table 42. Mainline Case Study – Results of Applying Progressive Electrification to the Conventional Electrification Scenario.....	173
Table 43. Mainline Case Study – Results of Applying Progressive Electrification to the Intermittent Electrification Scenario with Short OCS Gaps.....	173
Table 44. Summary of the Public and Private Rates of Return for the Four Scenarios Analyzed Within the Mainline Corridor Case Study	175

Executive Summary

The Federal Railroad Administration (FRA) contracted a research team from The University of Texas at Austin in 2023 to develop a framework for evaluating the updated costs and benefits of freight railway electrification considering traditional and modern innovative methods. The team reviewed past and current electrification studies and identified technologies and strategic operation and implementation approaches to improve benefits and reduce cost and risk. The “Cost, Uncertainty, and Risk of Railway Electrification with New Technologies” (CURRENT) model was developed as a risk-based economic analysis framework to aid railroads in evaluating electrification investments, and inform further supplier research and development.

After a review of past and current electrification studies, the team concluded that freight rail electrification has not been implemented to date by US Class 1 railroads because of various economic, technical, and institutional barriers. The primary barriers to freight rail electrification were found to be its high up-front capital costs, high risks due to the uncertainty of electrification in the North American context, and the presence of alternative investments that carry less risk. Over time, changing technology and a shift from using electrification to reduce energy costs to using it to reduce emissions have potentially altered the impact and relevancy of some of these barriers, and created pathways to overcome them.

Researchers performed an extensive literature review and identified several modern technologies and implementation strategies with the potential to address economic, technical, and institutional barriers while improving the costs and/or benefits of freight rail electrification. Mapping methods to streamline catenary construction, locomotive technologies, intermittent electrification,¹ and implementation strategies to the primary economic barriers revealed that many modern advances in freight rail electrification technology and strategy address multiple economic barriers on multiple fronts. Systemic changes, such as adopting alternative project delivery methods, can directly address costs, benefits, and risk. More frequent freight rail electrification projects will facilitate a dedicated design, supply, and construction industry that can develop standards, guidelines, and best practices to greatly decrease costs, an improvement over the historical practice of custom “one off” approaches developed specifically for infrequent electrification projects.

Dual-mode locomotives for freight service and intermittent electrification are two important approaches to improve project economics, but both require further research to prove their technical feasibility and determine more specific costs. Implementation strategies that include utility lease agreements for co-locating transmission lines in railroad right-of-way (ROW), or government partnerships or grant programs to capture the value of public health and climate benefits, offer the most promising pathways for improving freight rail electrification economics. Transferring some of the initial capital cost and risk of freight rail electrification from freight railroads to utilities and public agencies is critical to achieving freight rail decarbonization. Overall, several promising technologies and implementation strategies, taken together, offer a modern approach to railway electrification that is potentially more feasible than traditional electrification.

¹ Intermittent electrification refers to the concept of deploying discontinuous segments of OCS along a rail corridor with trains using electric traction under the OCS and some other means of traction to bridge the gaps.

The CURRENT model developed in this research implements a new risk-based cost-benefit framework for analyzing modern mainline freight rail electrification options. The team used the CURRENT model to evaluate various technologies and implementation strategies in two corridor case studies. Study scenarios included: traditional full electrification with an overhead catenary system (OCS) and electric locomotives; short gaps in the OCS at overhead obstructions using electric locomotives with onboard battery capability; intermittent electrification using battery locomotives that can charge in motion along short OCS sections along the route; and full electrification using battery-electric locomotives and no OCS. When electrification using battery-electric locomotives alone was not feasible, additional scenarios investigated progressive electrification where electro-diesel dual-mode locomotives (DMLs) were implemented to make use of OCS as it is constructed and energized along the route. To investigate different implementation strategies, each scenario was evaluated as a private railroad investment, with and without utility partnerships for co-location of transmission lines, and with and without the monetized value of public health and climate benefits from reduced diesel-electric locomotive emissions.

In each study scenario, the team used the CURRENT model to produce an estimated distribution of the rate of return based on the uncertainty in various factors and parameters that influence costs, benefits, and the implementation timeline. The case study results demonstrate how different corridors will require different approaches for decarbonization. Corridors with light traffic might work better with battery-electric locomotives, battery tenders, and charging facilities, while longer, traffic-dense corridors will tend to be more suitable for OCS. Even corridors with relatively light traffic densities could see significant public benefits, although a public policy mechanism that internalizes some of the public health and climate emissions benefits may be needed to incentivize railroads to electrify these corridors. Additionally, utility partnerships through ROW sharing can significantly improve the feasibility of electrifying a given corridor from the private railroad perspective. Most importantly, all stakeholders need to have a good understanding of the risks and uncertainties other stakeholders face so that a tri-party agreement can be reached to achieve mutual benefits and move freight rail electrification forward.

The results of the case studies rely on underlying assumptions and estimates of the distributions of future costs of various infrastructure and motive power technologies, diesel fuel, electricity, and carbon emissions. Additional research is needed to better understand the costs of making signaling and communications systems compatible with OCS, which is one of the largest capital costs involved. The interaction of freight rail electrification with the most common forms of Positive Train Control (PTC) is not well explored in the literature.

The disproportionate savings that arise from bridging short OCS gaps with a last-mile battery, combined with the operational flexibility that a last-mile battery provides, suggests that the development of an electric locomotive with appropriate battery capacity should be prioritized over a purely electric locomotive for the North American heavy haul freight market. The case studies exploring intermittent electrification with battery charging in motion (i.e., en route) reveal that there is a substantial research opportunity for developing algorithms that optimize the distribution of OCS along a corridor, which can maintain battery charge while minimizing the installation costs and civil construction works necessary to raise clearances. A research program to convert an existing AC traction locomotive to a dual-mode electric platform, develop an electric power tender, and investigate their combined performance and efficiency on an

electrified test track could substantially reduce uncertainty in the cost of implementing intermittent electrification and its associated risk.

1. Introduction

The Federal Railroad Administration (FRA) contracted a research team from The University of Texas at Austin in 2023 to develop a framework for evaluating the updated costs and benefits of freight railway electrification considering traditional and modern innovative methods. The objective of this project was to develop a framework for evaluating updated costs and benefits of freight railway electrification considering traditional and modern innovative methods. The team reviewed past and current electrification studies, and identified technologies and strategic operation and implementation approaches to improve benefits and reduce cost and risk. The developed risk-based framework can aid railroads in evaluating electrification investments and inform further supplier research and development, given current technological limitations and possible solutions to infrastructure and operational challenges.

1.1 Background

Railway electrification using overhead catenary wire suspended above the tracks to power mainline freight trains has been used in North America, and is applied to heavy haul freight operations in Sweden, Australia, South Africa, and India. However, since 1981, all line-haul freight rail operations in the United States have been powered by diesel-electric locomotives (and more recently by liquefied natural gas). While it is used on several passenger and commuter rail lines, electric traction for freight operations in North America is limited to industrial short lines and a few isolated, closed-loop mining railroads.

Past studies typically cite high initial capital cost as the largest obstacle to more widespread implementation of freight rail electrification. While the capital infrastructure and locomotive costs of traditional electrification are substantial, railroad companies are capital intensive and can justify large investments if they provide a satisfactory return. This return on investment (ROI) is typically derived from the lower operating cost of electricity relative to diesel fuel, particularly for studies conducted during periods of high petroleum costs (e.g., the 1970s, early 1980s, and mid-2000s). A primary challenge with this approach is that, to avoid the complexity and costly delay of mid-route locomotive changes, electrified operation cannot begin to provide a ROI until overhead catenary is installed and energized over substantially long mainline corridors encompassing multiple origin-destination train runs in their entirety. During the multiple years required to construct the required infrastructure and locomotives, there is no interim benefit, creating a large negative value position. There is also tremendous risk that diesel and electricity costs may change over this period, reducing or eliminating projected operating cost benefits and jeopardizing the overall ROI. This high risk makes mainline freight railway electrification an unattractive option for private railroad investment.

Despite this historical perspective, a new study of electrification costs and benefits is appropriate currently for two reasons. The first is that modern electrification decisions must be made within the current business environment with a focus on minimizing carbon emissions. While past studies were primarily comparing electricity with diesel propulsion, future studies may need to consider the impacts of a carbon tax or corporate net-zero commitments to eliminate diesel in favor of electrification, hydrogen fuel cells, batteries, or other low-carbon technologies. Such comparisons are complicated by the potentially wide spatial variation in the cost of carbon and energy supply between urban and rural areas, and the relative carbon-intensity of electricity and hydrogen in different regions of the US (depending on the mix of renewable and fossil fuel

generation). Making these comparisons is further complicated by considering the ability of the electrical transmission grid to support the power demanded by various electrification options, and the potential environmental impacts of required grid expansion.

Secondly, recent advances in various technologies have improved the feasibility of partial, progressive, and discontinuous electrification strategies to support electric operations on smaller, interim sections of networks and corridors. Dual-mode or rapidly improving battery electric locomotive technologies could potentially navigate gaps in electrification and eliminate the large expense of raising clearances under bridges or through tunnels. Unlike the DC traction locomotive models considered during earlier electrification studies, modern high horsepower AC traction locomotives could be readily adapted into electric locomotives during an interim operating phase, changing the locomotive replacement costs and potentially delivering earlier benefits. The combination of these two factors, a new carbon-focused decision context, and new technological and implementation approaches, dictates development of a new risk-based electrification cost-benefit framework.

1.2 Objectives

The primary objectives of this study were to provide a holistic understanding of the key technical and economic barriers to freight railway electrification in North America, identify potential innovative technologies and implementation approaches that offer modern options for freight rail electrification, and provide a framework to evaluate how the costs and benefits of these new approaches influence the overall risk of required investments in electrification infrastructure and equipment on mainline freight corridors.

It is expected that the railroad industry can use the set of innovative electrification solutions identified through this research as a roadmap for research and development to advance the feasibility of future electrification. As these technologies are developed and commercialized, the updated electrification cost-benefit framework can be used by railroads, consultants, and government agencies to make more informed decisions on implementing railway electrification.

1.3 Overall Approach

To accomplish the objectives of this project, the work was divided into three main stages or project tasks. During the first task, the project team reviewed and analyzed past and current railway electrification studies with a focus on identifying the key limitations of the proposed technology, infrastructure, and implementation strategy, and the primary factors influencing their costs, benefits, and risks. This literature review also identified past assumptions on the cost, benefits, and feasibility of mainline freight railway electrification options that are no longer valid due to changing economics, operations, and technologies.

During the second task, the project team reviewed alternative technologies and strategic implementation approaches to identify innovative solutions that may alter the primary cost factors or key limitations identified in the first task. This literature review included alternate approaches to constructing the overhead contact system; advances and development of alternative locomotive technology; new directions in traction power supply and grid connections; and operational strategies under partial, progressive, and discontinuous electrification. To be adopted on long mainline corridors, modern options for electrification must reduce the risk associated with their ROI through some combination of: 1) reduced initial capital infrastructure or locomotive costs; 2) increased operating benefits or the ability to yield interim benefits during

initial construction and implementation; and 3) reduced overall construction duration to yield benefits sooner and increase the likelihood of achieving the forecasted benefits and ROI.

During the third task, the project team developed an updated risk-based electrification cost-benefit framework and applied it in two freight rail corridor case studies. The new risk-based electrification cost-benefit framework and analysis tool considers new technologies and implementation and operational approaches within the modern railroad and environmental decision context. The framework considers variability and uncertainty in the capital cost of electrification infrastructure and locomotives along with that of energy sources. The team used a Monte Carlo simulation tool embedded within the economic analysis tool to consider the impact of uncertainty and variability in various parameters on the viability of various electrification approaches. The simulation considers user-specified or default parameter ranges and distributions to output a ROI or cost-benefit ratio probability distribution for a particular electrification scheme. The ability of this tool to provide a quantifiable measure of risk and level of confidence in each alternative is demonstrated via case study analysis of different electrification infrastructure and motive power approaches on two representative freight rail corridors.

1.4 Scope

This study focused on evaluating options for mainline electrification in the context of North American freight operations with additional consideration of passenger rail operations that may be supported on these corridors. Although many of the obstacles, alternative technologies, and implementation strategies documented through this study may be applicable in the context of lines primarily dedicated to commuter and passenger rail operations, these items are discussed and evaluated primarily from the viewpoint of freight operations. The risk-based electrification cost-benefit framework developed through this study reflects this perspective in being designed to initially evaluate different electrification options as a private investment by a for-profit railroad. Although the framework can be adapted to evaluate electrification projects as public agency projects by adjusting various model parameters, the case studies presented in this report exclusively feature freight rail operations.

The rationale for this scope limitation is the current lack of mainline freight rail electrification in North America. In contrast, North American passenger and commuter rail operations currently feature several electrified corridors, either as a legacy of predecessor railroad operations, or newly constructed to support higher-density or higher-speed operations (such as in the California Bay Area or the extension of the Northeast Corridor electrified territory to Boston).

In terms of alternative propulsion technologies for freight rail operations, this study is focused on options that involve, in whole or in part, electrification via an overhead wire or catenary commonly referred to as an overhead contact system (OCS). Alternatives to OCS such as third rail and induction are discussed but are excluded from the economic analysis tool for reasons documented in later sections. Battery locomotive technologies are examined because of their potential to offer hybrid and dual-mode capabilities in combination with OCS. Other electrification technologies (e.g., hydrogen fuel cells) and alternative fuels (e.g., biodiesel, natural gas, methanol, and ammonia) are outside the scope of the literature review and economic analysis, and are only mentioned briefly in the report to provide a broader decarbonization pathway context for the OCS-based options analyzed in detail.

The costs and potential benefits of various technologies discussed in the report are drawn from published literature, previous study, or outreach to manufacturers and industry practitioners. Similarly, case study parameters are drawn from previous study and industry best practices appropriate for the setting of each case study corridor. The project team did not engage in any original engineering or design work to establish more detailed or project-specific costs for the various technologies under study or their application to the case study corridors. The focus of this study was to determine how various technologies and implementation strategies may change the rough order-of-magnitude costs and benefits and their corresponding likelihood of producing a distribution of possible returns falling above or below a certain investment threshold. In doing so, researchers worked to demonstrate the potential of these technologies and implementation strategies with the goal of prompting industry practitioners to conduct more detailed project-specific analyses that leverage the developed risk-based electrification cost-benefit framework.

1.5 Organization of the Report

The remainder of this report is organized according to the three main project tasks. [Section 2](#) presents an overview of historical freight railroad electrification studies, while [Section 3](#) discusses common reasons why past freight rail electrification projects did not move forward. To demonstrate how the context and focus of electrification studies has shifted over time, [Section 4](#) reviews more recent rail electrification studies. [Section 5](#) then identifies common economic, technical, and institutional barriers to freight rail electrification.

The next sections shift the focus to describing alternative technologies and strategic implementation approaches for modern freight rail electrification. [Section 6](#) describes methods to streamline catenary construction while [Section 7](#) discusses various locomotive technologies. The concept of intermittent electrification is introduced in [Section 8](#), followed by various implementation strategies in [Section 9](#). These technologies and approaches are then mapped to the identified economic, technical, and institutional barriers in [Section 10](#) to summarize the work conducted under the first two project tasks.

The final sections focus on the economic analysis framework, with [Section 11](#) describing the high-level approach to the cost-benefit framework and the risk analysis methodology using Monte Carlo simulation to create a distribution of possible returns for each scenario under consideration. [Section 12](#) and [Section 13](#) summarize the results of analyzing various modern electrification options on two case study freight rail corridors. Finally, [Section 14](#) summarizes the overall findings and conclusions of the study.

2. Review of Past Studies

During the initial phase of the project, the research team analyzed 59 rail electrification studies spanning over 6 decades and multiple geographic regions. Examining the publication year distribution of the analyzed reports (Figure 1), the team found there was wide interest in rail electrification in the 1970s and 1980s, which waned before rebounding in the 2010s.

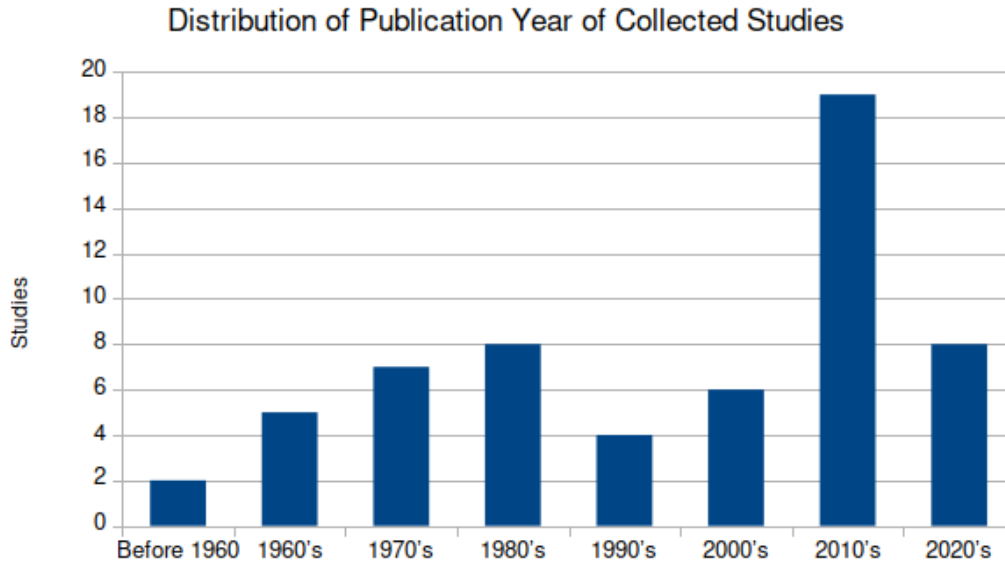

Figure 1. Distribution of Publication Years for Studies Analyzed in Task I of the Project

The rest of this section consists of case reviews about past mainline railway electrification studies. Common trends in the case studies analyzed go beyond industry-wide trends, and help to explain why most of the electrification projects did not move forward.

Much of this report, particularly this section, requires analysis of historic monetary values. Researchers attempted to contextualize historic monetary values by reporting estimates of real values adjusted for inflation. Because the reports analyzed cover six decades and multiple industries, researchers used the Bureau of Labor Statistics' Consumer Price Index to simplify the calculations and provide a degree of consistency. There are more nuanced, industry-specific price indices that could be used in subsequent reports that include values pertinent in future economic analysis (Bureau of Labor Statistics, 2024).

In reviewing past electrification studies, it is important to distinguish the context in which those studies broadly occurred. Technical, economic, and environmental circumstances were different in the past and likely will be in the future, so the information gathered in these studies may be more informative than some of the conclusions. The team found seven key differences between past studies and current research.

1. There were different goals in historical electrification studies.

The primary drivers of electrification studies in the past (following the conversion from steam locomotives to diesel) was replacing diesel fuel and propulsion with coal-generated electricity and electric locomotives, to mitigate expected diesel fuel price increases. In contrast, the key

driver today is the desire to decarbonize railroads without ceding market share; environmental goals were much less relevant in the past.

2. Locomotive technology has changed.

The baseline diesel locomotives in 1980 were “semi-mass produced” 3,000 hp 6-DC-motor (EMD SD40-2s and GE C30-7s) and the baseline domestic electric locomotive was the GE E60C (6,000 hp 6-DC-motor). Today, baseline diesel locomotives are 4300-4400 hp 6-AC-motor (SD70ACe and ET44AH) and no domestic electric locomotives have been built since the late 1980s (seven 6,000 hp GF6C’s for BC Rail, all with DC motors).

3. Previous electrification studies assumed freight operations would shift to resemble Europe.

Electrification studies in the 1970s and 1980s often looked to Europe for the future of North American electric locomotives. Many studies assumed that electrification would bring trains with a high power-to-weight ratio and the necessity for high power locomotives – 6,000 hp to 9,000 hp in some cases. This was based on the European experience of lightweight freight trains interspersed with passenger trains, maintaining high power-to-weight ratios to maintain very high line speeds. Past studies assumed that one of the benefits of electrification would be, on average, higher speed freight operations, which is not currently an industry goal in North America.

4. The industry has shifted to AC traction motors.

Modern locomotives are more productive and provide significantly more power and tractive effort. DC locomotives were limited to about 21-24 percent adhesion (versus up to 45 percent in AC traction locomotives today) and about 3,000 to 4,400 hp. DC traction motors were difficult to control at high power (e.g., to avoid wheel slippage), could easily be damaged thermally, and older locomotive trucks (i.e., bogies) have been replaced by superior designs capable of supporting AC’s higher adhesion and tractive effort.

5. The electric utility industry has reorganized.

In the past, generation and transmission of electricity were fragmented, and generating stations and transmission facilities were often co-owned. Deregulation of electric utilities occurred on a state-by-state basis. The utility industry now is more fractured and diverse, but there are also Regional Transmission Organizations (RTOs) and Independent System Operators (ISOs) that manage power flows within large regions of the country in an attempt to balance electrical energy supply and demand, as shown in [Figure 2](#) (Federal Energy Regulatory Commission, 2024).

The electric utility industry is continuing to undergo change as it seeks to locate, fund, and construct large amounts of decarbonized energy, primarily in remote areas requiring new transmission lines to reach urban power users. This need for new transmission lines to incorporate clean energy sources creates the potential for large co-benefits with rail electrification. Freight railroad right-of-way (ROW) could make decarbonized energy sources easier to incorporate into the grid, and connecting them to the grid makes the grid cleaner, increasing the environmental benefits of rail electrification.

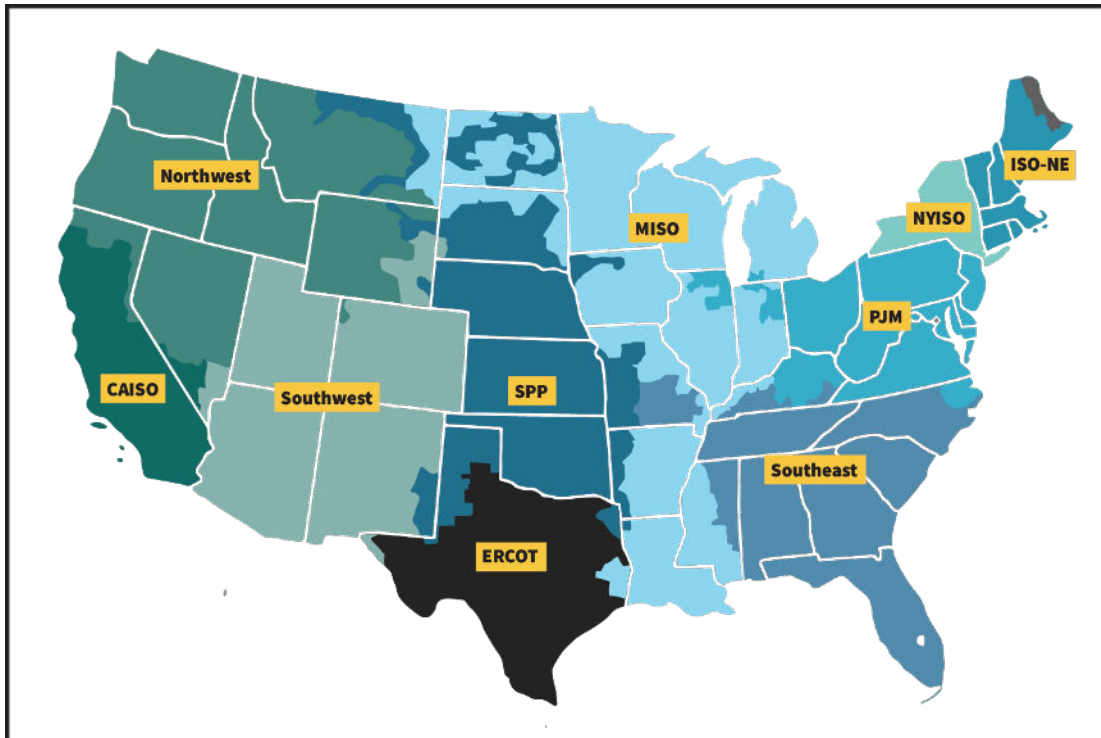

Figure 2. Map of RTOs and ISOs Across the Country

6. *Railroads were facing a different regulatory environment and different investment opportunities.*

The interest in mainline freight rail electrification coincided with a time of significant change in railroad industrial organization. Large railroad mergers following the success of the Conrail consolidation and deregulation offered lower-risk avenues for capital investment with much quicker payback periods.

7. *Environmental permitting requirements have changed.*

Some electrification studies pre-date passage of the National Environmental Policy Act (NEPA) in 1970, or were conducted during the formative years of the Environmental Protection Agency (EPA) in the 1970s, when environmental permitting for electrification would have been nonexistent or substantially less stringent than that for current projects. Environmental permitting will add schedule time, cost, and complexity to future mainline electrification projects in the same manner as the extensive railroad industry permitting effort required for installation of Positive Train Control (PTC) communication infrastructure during the 2010s. However, changes in permitting requirements have also impacted the ability of utilities to construct new electrical transmission lines, providing a stronger incentive for co-location of these facilities along railroad ROW.

2.1 Southern Pacific (1964-1974)

The Southern Pacific Railroad (SP) evaluated electrification in a series of studies between 1964 and 1974. SP electrification studies were conducted before the intense electrification scrutiny of the late 1970s and early 1980s, when there were few answers to how several technical aspects of

electrification would work. SP worked on these studies alongside electric utility companies, but at several junctures, poor communications or misunderstandings about the other's needs prevented deals from moving forward.

Three innovations from the various studies performed by SP are worth highlighting:

1. SP identified the possibility of utilizing shared ROW agreements with electric utilities to make electrification more viable.
2. Creating a separate entity to manage the electrification infrastructure, in partnership with the utilities, might reduce the overall risk of electrification for the railroad and allow for better financing.
3. SP identified that while the risk of unilateral electrification was too high for the railroad, environmental factors in the future might tip the scales to make electrification a strong investment.

The work completed by SP helped to set the stage for studies that would take place at other railroads over the following decade and included several potential novel solutions, such as risk sharing partnerships with the utility companies that could make electrification more viable. Ultimately, SP decided that mainline electrification involved too many unknowns to justify the risk of investment.

2.1.1 Detailed Overview

In the mid-1960s, SP undertook the first major Class I electrification studies since the Great Depression; there was a 30 year gap from when the last significant segments of rail had been electrified and SP's study. The information presented here comes from SP archival material (e.g., internal reports and memoranda) accessed specifically for this project. SP developed criteria to select lines for detailed electrification analysis: heavy traffic density, the desire to maintain maximum speeds across high grades (a much larger concern with the constraints of DC-traction diesel-electric locomotives of the era), favorable electric power rates, and catenary construction costs. SP used those criteria to select the following corridors for electrification studies:

- Portland, OR – Klamath Falls, OR
- Bakersfield, CA – Palmdale, CA – Indio, CA
- Bakersfield, CA – Los Angeles, CA
- Los Angeles, CA – Indio, CA – El Paso, TX
- Roseville, CA – Sparks, NV

The electrification studies were conducted by SP internally and consultants hired by various electrical utilities that would become involved in the various project proposals.

2.1.2 Initial Miscommunications (Portland – Klamath Falls)

The studies initially focused on the route from Portland to Klamath Falls because the local electrical utility proposed furnishing single-phase 25 kV power at a rate equivalent to one-half the then-current equivalent cost of diesel propulsion. The low rate was proposed on the assumption that the utility could monetize under-utilized generating capacity in off-peak hours. The utilities and their consultants proposed a scheme whereby the utility would build and

maintain the OCS while SP would provide electric locomotives and pay for the electricity consumed at the wire. This arrangement greatly reduced the capital cost borne by the railroad compared to electrification developed solely by the railroad as a traditional capital expansion project. The estimated costs for electrifying the Brooklyn Yard (Portland) to Klamath Falls segment (375 km or 233 miles) in 1966 were:

- Signal work – \$7.8 million (roughly \$76 million today)
- Communications – \$2.4 million (\$23 million today)
- OCS (minus the cost of new transmission feeders) – \$8.5 million (\$82 million today) and \$36,000 per mile (about \$350,000 per mile or \$217,000 per km today)

The economics of the proposed project quickly fell apart when SP realized that they could only receive the low electricity rate by running trains in off-peak demand periods. During peak demand periods, the utilities factored the full cost of building the generating capacity and transmission supply to power trains into the electricity cost charged to the railroads.

2.1.3 Signal Concerns

The incompatibility of existing railroad signal systems with AC electrification was raised in the initial study and recurred in subsequent studies. Existing DC track circuits would need to be replaced by AC track circuits to accommodate the routing of return electrification current through the rails. Also, communication pole lines paralleling the ROW would need to be protected from electromagnetic interference induced by the OCS. The combined cost of addressing these problems was estimated at \$30,000 per mile in 1966. The ongoing conversion to microwave communication was proposed as one solution to the interference problem. While a combination of microwave, radio, and fiber optic technologies has largely eliminated pole lines in the current North American freight context, the problem and cost of DC track circuits remains an obstacle to electrification. Within the SP electrification studies, it is often unclear whether the utility or railroad would cover the cost of these signal upgrades, which constituted a significant portion of the total capital outlay. There also appears to be internal disagreement regarding whether the cost of signal upgrades should be charged against the electrification project and factored into the cost-benefit analysis, or if the signal upgrades should be considered an improvement to the physical plant and charged against the broader capital improvement project budget on its own merits.

2.1.4 Uncertainty Over Electric Locomotive Costs

Another concern raised by SP was the lack of off-the-shelf design or domestic experience with 25 kV single-phase electric locomotives of sufficient power and tractive effort performance for heavy haul freight service. The capital cost of locomotives would likely be a custom design requiring substantial research and development. With a relatively small fleet over which to allocate these development costs, the electric locomotives would likely be substantially more expensive than diesel equivalents. However, if locomotives of higher horsepower and tractive effort could be developed, it was hoped that some of this price premium could be offset by a reduction in the number of locomotives required for an electrified train compared to a conventional diesel-powered train. In addition to potentially requiring fewer locomotives per train, availability for electric locomotives was estimated at 94 percent compared to 84 percent for diesel-electric locomotives.

Several studies conducted by utility consultants identified the benefit of increased train speeds with higher-horsepower electric locomotives, but SP disregarded these potential benefits as largely unachievable or unrealizable given other constraints on the railroad operating plan and the time spent by railcars waiting for train connections at intermediate classification yards – another example of poor communication between the stakeholders.

2.1.5 Closer to a Breakthrough with Right-of-way Agreements

While misunderstandings between electrical dispatching and rail dispatching scuttled early studies, communication between the railroad and the utility companies in those studies identified a mutually positive benefit: SP noted the possibility of using railroad ROW for power transmission purposes by utilities as one way to improve the feasibility and economics of railway electrification. Additional income from joint use of ROW with electrical utilities could be credited toward the benefits of railway electrification. In 1968, Southern California Edison (SCE) experienced problems obtaining transmission line rights-of-way in the Los Angeles area, and access to SP ROW was valuable. This was a breakthrough at the time, and researchers of the current rail electrification project believe this option warrants further scrutiny today. Right-of-way sharing agreements are discussed further in later sections of this report.

A subsequent study focused on electrifying the SP line over Donner Pass in the Sierra Nevada mountains from Roseville, CA, to Sparks, NV. The primary obstacle was the cost of power supply because the existing transmission line did not have sufficient capacity to meet the demands of the added railroad load, making construction of a new line cost prohibitive.

Studies of the lines near Bakersfield found that the demand-based electrical charges proposed by the local utilities did not offer economics favorable to electrification. SP noted that without a long-term negotiated rate structure – one that was not subject to demand-based charges – the railroad could not predict the real costs of electrification and thus the investment would be subject to considerable risk and uncertainty. SP stated that they desired a commodity-type rate with a minimum charge per month, a load-based charge, and an annual facility charge to cover the utility investment in the OCS and related transmission facilities.

2.1.6 Later Studies

In late 1968, a consultant study sponsored by SP and SCE found that 50 kV electrification was feasible for the Colton – Indio – Yuma route, totaling 301.5 single-track miles at a cost of \$19.5 million (\$176 million in current dollars). The average cost was \$77,000 per single-track mile from Colton to Indio, and \$56,000 per single-track mile from Indio to Yuma. The SP-SCE consultant report notes that these costs do not include any costs associated with providing additional clearance at overpasses, provision of the power supply system, and resolving utility conflicts with power and telephone lines.

A year later, General Electric conducted their own study of electrifying the SP line from Colton to El Paso (760 miles). The cost for installing the electrified system was estimated at \$115 million (\$995 million in current dollars), consisting of \$19.3 million for signals and communications, \$53.4 million (\$71,000 per mile) for catenary, \$35 million for a transmission line paralleling the railroad, and \$7.2 million for electric locomotives and maintenance facilities. In this study the electric locomotives and maintenance facilities would be the only required investment by SP if the utilities along the route furnished the catenary system. The rate of return

for utility operation of the catenary system over 30 years was estimated at 17 percent after tax, rising to 23 percent if a third-party lease plan could be established.

In the same year, a revised and more comprehensive study on the Colton – Yuma route was completed for SP and SCE. The total cost rose significantly to \$34 million (\$294 million in current dollars), consisting of \$9.7 million for transmission line upgrades, \$5 million for traction substations, \$17.6 million for the OCS, \$1.3 million for overhead clearances, and \$0.4 million for eliminating inductive interference in the signal system (roughly a cost of \$607,000 per track-km, or \$977,000 per track-mile in current dollars). Based on this study, SCE proposed an electric rate structure that consisted of a monthly charge per route-mile, a monthly charge per locomotive including a load factor, an energy charge per kWh, and a monthly catenary charge per mile of catenary operated. Based on these charges and rates, the annual total electric charge for SP on the Colton – Yuma route was estimated at \$9.6 million (\$83 million per year in current dollars).

By 1970, SP and a consortium of utilities extended the previous SP-SCE studies to examine electrifying the entire 1,223 km (760-mile) mainline from Colton to El Paso at 50 kV. SCE proposed to furnish material for the Colton – Yuma segment (317 km, 197 miles), while Arizona Public Service, Tucson Gas & Electric, New Mexico Public Service, and El Paso Electric jointly proposed to furnish the Yuma to El Paso segment (906 km, 563 miles). The total cost to all parties at the time of construction was estimated at \$228 million (\$1.86 billion in current dollars), with an additional \$25 million (\$204 million in current dollars) required from SP for various infrastructure and physical plant improvements. The annual electrical cost for SP at the wire was estimated to be \$10 to \$12 million per year (\$82 to \$98 million per year in current dollars). The studies estimated that over 35 years, the rate of return would be between 10 and 15 percent after taxes.

Table 1 summarizes the costs for the historical electrification studies highlighted in this case study. One important trend to note is that the general cost per unit distance increased over time (in real dollars) as SP studied the problem. This was true in general, and specifically when the same corridor was analyzed in greater detail. As SP grappled with profitability, this trend might have highlighted the risks involved with electrification.

Table 1. Summary of SP Electrification Studies

Study Author	Segment	Year	Segment Length km (mi)	Total Cost 2024 \$ millions	Cost Per Distance 2024 \$ thousands per km (per mi)
SP	Portland – Klamath Falls	1966	375 (233)	\$181	\$484 (\$778)
Consultant	Colton – Indio – Yuma	1968	485 (302)	\$176	\$363 (\$585)
SP & SCE	Colton – Yuma	1969	485 (302)	\$294	\$607 (\$977)
GE	Colton – El Paso	1969	1223 (760)	\$995	\$814 (\$1310)
SP & Utilities Consortium	Colton – El Paso	1970	1223 (760)	\$2064	\$1690 (\$2720)

2.1.7 Catenary Associates

After the most comprehensive study in cooperation with the utility consortium, SP noted that substantial cash deficits would accumulate during the early years, but would be offset in later

years as traffic increased and energy and operational savings of the electrification accrued. If implemented by 1974, there would have been an adverse effect on earnings-per-share through 1982 (a period of eight years) and on cumulative cash flow through 1990 (a period of 16 years). SP proposed to establish a limited partnership known as Catenary Associates. Catenary Associates would enter a ground lease and take on constructing the catenary system as a lessee improvement, becoming SP property as lessor upon termination of the lease. This third-party structure would shift many initial costs from SP to Catenary Associates (and the partnering utilities), and provided a means for long-term deferral of loan payments until railroad cash flows from electrification increased sufficiently. The study noted that this electrification venture involved large financial risks if traffic forecasts, energy forecasts, and technical performance failed to meet expectations. All the utility capital costs would ultimately have been passed on to SP over time through the electricity rate agreement, but SP notes that it was difficult to determine what SP's liability would be if the agreement were terminated early and use of the electrification discontinued, presenting another source of risk.

This partnership structure, combined with the inroads SP made regarding ROW sharing agreements with electric utility companies, might provide a template from which modern electrifications could build.

2.1.8 Termination of Electrification Studies

By 1973, SP management indicated that while work to refine the 1970 study of the Colton to El Paso corridor was ongoing, the electrification plan was no longer a priority for SP. The railroad had many competing capital requirements, and the large expenditure required for electrification could not be justified when there were more pressing requirements or multiple smaller investments in other projects that produced overall greater returns on investment with less risk and uncertainty. At that time, SP did note that emerging problems with energy and the environment might change the rationale and economics driving electrification, but such developments would likely require the government to assume a role in railway electrification. SP suggested that the federal government should conduct research on technological issues surrounding electrification so that the railroads would have greater certainty when estimating various electrification costs and benefits required to justify the large capital investments.

In 1974, further review of the Colton to El Paso study found that the traffic growth assumptions used for the study appeared to be overly optimistic. Because the actual traffic trends at the time might not have justified electrification and SP management had pressing concerns regarding the immediate profitability of SP in general, any further study of electrification was deferred indefinitely.

2.2 TVA with the Southern and L&N Railways (1978-1982)

In the late 1970s, the Tennessee Valley Authority (TVA) approached the Southern Railway (SR) and Louisville and Nashville Railway (L&N) to propose the electrification of their respective Cincinnati – Atlanta corridors. Both routes were roughly 800 km (500 miles) in length, although the actual track-miles varied. TVA offered both railroads \$100 million (about \$370 million in current dollars) through an innovative public-private partnership involving the creation of a corporation, called the Railroad Electrification Management Corporation (REMC), that would be responsible for constructing the OCS. TVA and other utilities would be responsible for building

transmission infrastructure, while the railroads would be responsible for locomotive acquisition and long-term route maintenance.

TVA’s primary motivation was to create a visible rail electrification project with strong economics to demonstrate electrification’s viability and incentivize other railroads to follow suit. The organization hoped to reduce petroleum use in the wake of the 1970s oil crisis. Momentum for the project began to build during the same timeframe that both SR and L&N were involved in separate mergers, which took away capital for electrification. Electrification was considered a relatively risky investment, being subject to fluctuations in electricity and diesel prices, and SR made its position clear – it was only willing to invest in electric locomotives. TVA would have to pay the full amount of the OCS for the project to move forward, which it was unable to do.

2.2.1 Project Description

The TVA is a federal electric utility public corporation responsible for electricity, water management, and economic development across Tennessee and parts of neighboring states. In the late 1970s, the TVA made inroads to add rail electrification to its portfolio motivated by a desire to reduce petroleum consumption in the wake of the oil crisis of the 1970s (McClellan, 1978) (Tennessee Valley Authority, 1980). A May 1980 letter stated, “We believe the time has come to move aggressively toward demonstrating the benefits to the railroad industry and the Nation of electrifying high-density rail lines” (Freeman, 1980). TVA devised the Railway Electrification Demonstration Project (REDP) to demonstrate the efficacy of rail electrification and incentivize other railroads to electrify.

TVA initiated contact with SR and L&N to electrify those railroad’s respective mainlines between Cincinnati, OH, and Atlanta, GA, as a demonstration project (Clarke, 1980). Clarke notes that the purpose of this project was to reduce diesel fuel consumption. Planners believed the project’s economics might convince other railways to undergo similar projects, and that 15 percent of diesel operations across the country might be converted to electricity (Clarke, 1980).

TVA initially considered five corridors passing through its territory for the REDP. The other routes considered were the Clinchfield Railroad through Tennessee, L&N’s Louisville – Nashville – Chattanooga – Atlanta route, and Illinois Central’s Chicago – Memphis route. Contributing factors toward TVA’s choice of the Cincinnati – Atlanta corridors were good economic return, cooperation from the railroads in question, cooperation from the utilities involved, the possibility for route expansion in the future, and the routes’ visibility as a demonstration project (Tennessee Valley Authority, 1980). The Cincinnati – Atlanta mainlines handled (and still handle) high volumes of freight traffic. Table 2 shows the lengths involved in electrifying the two corridors, and the amount of traffic being carried in 1980 (Tennessee Valley Authority, 1980).

Table 2. SR and L&N’s Cincinnati – Atlanta Mainlines

Railroad	Road Length of Electrification km (miles)	Track Length of Electrification km (miles)	1980 Traffic MGT/year
Southern Railway (SR)	804 (500)	1207 (750)	55
Louisville and Nashville Railway (L&N)	801 (498)	978 (608)	40

TVA offered to provide \$100 million (roughly \$493 million in current dollars) in capital funds to both railroads through the creation of a management corporation that would construct the OCS, while the railroads would be responsible for procuring electric locomotives (Kidder, 1982). Two alternative electrification configurations were considered: 25 kV with 26 substations, or 50 kV with 11 substations. Either configuration would have used 60Hz AC (Kidder, 1982). The next section details the structure of the deal and the division of responsibilities.

2.2.2 Structure of the Deal

Documents show that executives from SR and L&N attended a TVA board meeting in Knoxville, TN, in June 1980 (Tennessee Valley Authority, 1980). A presentation from the meeting shows the general structure of the deal being considered, which was similar to modern public-private partnerships.

The organizations would have created the REMC during Phase 1 of the project. The REMC would have built and owned the OCS and substations and would be responsible for financing and any further electrification associated with the project. At the time of the meeting, it was undecided whether the REMC would be for-profit or non-profit, and whether it would be responsible for modifying the signal and control systems. Another point of debate was whether the railroads or the REMC would be responsible for purchasing electrical power at the transmission level from the utilities (including TVA). Transmission facilities themselves would be constructed by TVA and the other utilities involved, and TVA would also be responsible for the initial organization and support of the REMC, funding the initial utility to railroad interface, and general governmental coordination of the project. The railroads would be responsible for procuring electric locomotives, maintaining the road and track structure, and, notably, maintaining the OCS. The deal also made it clear that railroads would maintain train dispatching authority (Tennessee Valley Authority, 1980).

The total budget for the project was \$470 million at the time, roughly \$1.8 billion in current dollars, with an aimed completion by 1984. The presentation at the TVA board meeting is unclear regarding the breakdown between the three partners in contributions to the project, but other reports from the time period indicate TVA executives believed they could obtain \$200 million in Congressional appropriations for the project, which they planned to divide evenly between the two corridors (McClellan, 1978) (Clarke, 1980) (Kidder, 1982). The \$200 million would flow through the REMC. Researchers have not found, at the time of writing, any indication of whether the remaining \$270 million capital expense (just over \$1 billion today) would have been split evenly between the railroads, or if it would have depended on the track-miles of electrification for each railroad's corridor. This expense included project design and construction, but would not have included the cost of the electric locomotives for the railroads (Tennessee Valley Authority, 1980).

2.2.3 Projected ROI, Benefits, and Drawbacks

TVA chose the Cincinnati – Atlanta corridors because of the large volume of traffic they handled, which made a strong ROI more likely. TVA estimated a 15.5 to 21 percent rate of return, with the wide range due to uncertainty in the relative cost of diesel and electricity. SR's own estimate of at least 15 percent aligned with TVA's analysis, but SR cited the large amount of upfront capital and the uncertainty of fuel prices, including the heavy linkage between electricity rates and fuel rates, as reasons to avoid committing to electrification (Kidder, 1982).

TVA's analysis assumed a traffic density of at least 44-50 MGT per year and 750 track-miles electrified (Kidder, 1982). As of 1998, various segments of the corridor carried far more traffic than TVA assumed for its economic analysis. Table 3 shows the traffic density assumed in 1982 for TVA's 15.5 to 21 percent rate of return, versus the actual traffic along the corridor in 1998.

Table 3. Tonnage Hauled along the SR Route (MGT)

Segment	1982	1998
Full Corridor (TVA Assumption)	44-50	57-85
Cincinnati – Danville		57
Danville – Oakdale		77
Oakdale – Chattanooga		57
Chattanooga – Atlanta		85

TVA's presentation to the railroads noted several benefits and drawbacks of the project (Tennessee Valley Authority, 1980). Benefits included:

- Reduction in the use of petroleum
- Increased life of locomotives (due to the lack of a prime mover)
- Reduced number of locomotives (due to, at the time, better power and adhesion in electric locomotives)
- Reduced locomotive maintenance cost (due to both previous reasons)
- Smooth acceleration (due to better adhesion)
- Less servicing per run
- Less environmental impact
- Rate of return greater on high-density lines
- Increased traffic efficiency

TVA listed the following reasons railroads do not electrify:

- Institutional problems
- Long-term investments hurt credit standing
- Long-term earnings prospects discourage long-term capital-intensive programs
- Benefits are gradual and long term while initial capital is needed up front
- New investments in electrification may become subordinate to previous railroad mortgage commitments
- High risk associated with predicted fuel price differentials and railroad traffic growth

TVA's proposed deal structure appears designed to address some of those downsides, particularly by shifting some of the upfront capital expenditures to the REMC. These benefits and drawbacks are similar to reasons given for and against electrification today. While the proposed structure of TVA's REDP tried to address the railroad's concerns, the railroads were still hesitant.

2.2.4 End of the Project

By the early 1980s SR made its position on the deal clear: it would be willing to participate in the project if it would only be responsible for the locomotives. In 1982, SR “concluded that the uncertainty of future fuel prices (and consequently the relative price of electric power and diesel fuel) restrains any current decision to electrify unilaterally. However, the president of SR, Harold Hall, offered to ‘go halves’” (Kidder, 1982). If the public (through TVA or state departments of transportation) paid for the catenary, SR would buy the necessary electric locomotives.

In a SR memorandum written soon after initial contact from TVA, James McClellan indicated that TVA was initially interested in electrifying either SR’s CNO&TP route or L&N’s route if the railroads could broker a track sharing agreement. The memorandum notes that SR considered such an agreement unfeasible due to capacity constraints and lack of connecting links (McClellan, 1978). TVA’s focus seems to have shifted toward electrifying both corridors. The \$200 million offered by TVA for the project (\$793 million in current dollars) might have come close to fully funding the infrastructure along one of the corridors – it is possible TVA hoped to obtain more funds by the time it was planning to electrify both corridors, but it is also possible the organization always expected some private participation in the capital investment.

It is also unclear if the issue of who would be responsible for modifying signal and control systems was ever resolved. As negotiations continued, both SR and L&N became involved in separate corporate mergers (eventually becoming part of Norfolk Southern and CSX, respectively), which seems to have marked the end of the project.

2.3 Conrail (1979-1981)

Conrail inherited significant portions of electrified track from its predecessors, primarily in southeastern Pennsylvania. The organization investigated the feasibility of expanding its electrified operations with an eastern expansion parallel to the Northeast Corridor and a westward expansion past Pittsburgh. Its forecasts projected a roughly ten-year payback period for the project, but the uncertainty of the investment was too great to attract enough investors.

Examining the forecasts used in the analysis against what occurred shows that the traffic projections might have been optimistic, although a more detailed analysis would be necessary to determine retrospectively how much lower the ROI might have been than forecast.

2.3.1 Electrification Plan Overview

Conrail’s electrification plan called for more than doubling the 233 route-miles of electrified rail inherited from the Pennsylvania Railroad by adding an additional 342 route-miles of electrification across New Jersey and Pennsylvania. The plan did not call for electrifying branch lines, secondaries, or yard tracks – even with a full build-out, Conrail was planning to use diesel power for local service. The plan designated seven change-points where trains entering the electrified territory would swap locomotives. The plan also called for smaller substations than needed to supply its heaviest freight trains passing through the steeper sections of the Allegheny mountains. Smaller substations would require diesel helpers to assist the electric locomotives to pull the trains in those areas, rather than building larger electric infrastructure.

Conrail had three existing servicing bays for electric locomotives. The plan also called for the construction of two new locomotive servicing bays in the electrified territory, as well as the conversion of a further five bays from diesel servicing to electric.

2.3.2 Cost-benefit Analysis

Conrail projected savings of nearly \$5.2 billion (current dollars) in fuel costs over the study’s 29-year lifespan. Based on an internal analysis of the amount of locomotive maintenance related to the diesel prime mover (roughly 41 percent of maintenance costs), as well as a report from Swedish State Railways from the late 1970s that found its organization’s electric locomotives cost 58 percent less to maintain than the diesel fleet on a per-mile basis, additional savings were expected to come from lower maintenance costs. At the time, the analysis did not consider public benefits the project would provide.

Construction estimates included amelioration of 179 clearance restrictions, ROW acquisitions for electrification equipment and certain tunnel expansion, \$4 million for protective static discharge barriers on road and pedestrian bridges, signal system costs, locomotive costs, and other costs. The total investment, detailed in Table 4, amounted to just over \$1 billion (around \$270 million in 1980 dollars). Table 4 also shows the cost breakdown for the diesel base case, implying that the net investment for electrification was \$868 million. The information in the table comes from Marchinchin (2013), and was converted to current dollars.

Table 4. Conrail’s Planned Investment Costs for Electrification from 1980-2010

Fixed Plant Investment	All costs in millions converted to current dollars		
	Electric Case	Diesel Case	Net Investment
Catenary	169	n/a	169
Substations	90	n/a	90
Communications	55	n/a	55
Signal Systems	100	46	54
Civil Reconstruction	33	n/a	33
Design And Engineering	40	5	34
Construction Management	18	4	15
Other	65	18	46
Total Fixed Plant Investment	570	74	497
Rolling Stock Investment	Electric Case	Diesel Case	Net Investment
Electric Locomotives	1 565	n/a	1 565
Diesel Locomotives	825	7 743	- 6 917
Credits	726	2 830	- 2 104
Total Locomotive Investment	1 664	4 913	- 3 249
Terminal Value of Locomotives After Year 2010	1 222	4 841	- 3 620
Net Rolling Stock Investment	442	71	371
Total investment	1 013	145	868

Conrail’s electrification study depended heavily on core traffic growth forecasts out to 2010, twenty-nine years into the future at the time. Those forecasts included a “medium growth scenario” that projected 60 percent growth from 1977 levels – 267.8 million tons annually in 1977 to 426.1 million tons in 2010. That medium growth scenario fell far short of the actual growth the corridor experienced, demonstrating the amount of risk involved in these types of projects.

Despite the optimistic growth forecasts, Conrail estimated a payback period of almost 10 years, based on 3 years of construction and net annual operational savings of \$84 million. The 29-year rate of return was estimated at 17.7 percent for the segments between Harrisburg and Pittsburgh, and at 23 percent for the segments between Harrisburg and Newark, for an overall rate of return

of 18.1 percent (Kidder, 1982). Congress allocated \$200 million in federally guaranteed loans to help finance the project, but the payback period was deemed too risky, and Conrail did not move forward with their electrification plans. “Uncertainty is anathema to lenders,” Conrail's newly appointed Chair L. Stanley Crane wrote to Congress in 1981, describing the railroad’s financial situation. “The present cloud over Conrail's future, coupled with unsettled money market conditions, has closed the Corporation's access to private capital markets, preventing Conrail from financing new equipment” (Marchinchin, 2013). Conrail determined that, if it were to pursue further electrification, it would require greater public investment than the potential \$200 million on offer. When the new administration decided to leave railroad electrification to the private sector, Conrail ceased pursuing the expansion of its electric territory (Kidder, 1982).

By April of 1981, Conrail ceased its electric freight operations entirely, even across its existing electric territory (Kidder, 1982). The area across which its electric fleet could operate was too small to justify the continued cost of separate maintenance facilities, along with internal frustration at dealing with the Amtrak-owned Northeast Corridor. At that time, Conrail’s electric locomotive fleet was relatively old, and had lost much of its maintenance advantage.

2.3.3 Conrail’s Evolving Investment Goals

When Stanley Crane arrived from SR to become the new chair of Conrail, he shifted the management and Board of Directors of Conrail to focus on stabilizing revenues and turning steady losses into profit. The company aimed to move the operating ratio below 90 percent, and then targeted a ratio below 79 percent. Class I railroads currently have operating ratios in the range of 60 to 65 percent, but at the time this was an ambitious target given the losses that had been accruing. Around the start of Crane’s tenure, Conrail had ceased service on some 7,100 km (4,400 miles) of rail lines that accounted for only 1 percent of its traffic and only 2 percent of its profits. This move saved the company substantial amounts in maintenance outlays, and was indicative of the overall strategy to increase profitability first and foremost.

With this focus on profitability, the last Strategic Plan (ca. 1992) did not consider electrification at all. By the period 1996-1999, Conrail had achieved its profitability targets to become an attractive investment for CSX and Norfolk Southern to buy portions of the company (42 and 58 percent, respectively). While electrification might have eventually generated positive returns for Conrail, it was not part of the company’s strategy during its last two decades to generate low-risk profitability quickly.

2.4 BC Rail Tumbler Ridge Subdivision (1981-1983)

BC Rail considered and rejected electrifying its mainline in 1968, and again rejected electrification for a coalfields branch to northeastern British Columbia in 1975. Initially, the railroad noted that the cost of electricity needed to fall relative to diesel to make electrification feasible, and later electrification was rejected due to uncertainty around some of the costs of electricity, as well as a desire to minimize tunnel boring costs. By 1981, the organization had realized that the long tunnel under construction for the Tumbler Ridge Subdivision would require expensive ventilation to allow for normal diesel operations. The railway revisited electrification for the subdivision, and ultimately chose electrification as the preferred alternative.

The subdivision operated under electric traction for 15 years before reductions in traffic and improvements in diesel technology caused BC Rail to retire its electric fleet to streamline its operations.

2.4.1 Tumbler Ridge Overview

The BC Rail's Tumbler Ridge Project makes a good case study because of the unique circumstances that led to electrifying the line, in contrast with the various projects already discussed which did not reach completion. BC Rail built this relatively rare, successful example of freight rail electrification in the North American context in the early 1980s in northeastern British Columbia. A caveat is that this project is not an example of electrifying an existing line, but rather of the railway choosing to implement electric traction as part of the construction of a new branch line. The primary motivation for constructing the 130-km (81-mile) rail line was to access and develop new deposits of metallurgical coal in northeastern British Columbia. Once the mines began production, new coal traffic would utilize the branch and the existing BC Rail mainline to port for eventual export to Japan and use in steelmaking. The revenue from the volumes of new export coal traffic projected in the late 1970s were sufficient to justify a nearly \$500-million investment in the project (in 1982 Canadian dollars, roughly US\$1.1 billion today). Construction began in 1981 and the first train departed the new mine site in November 1983.

A key consideration in the design and operation of the new line was the need to have two substantial tunnels: the 9 km "Table Tunnel" and the 6 km "Wolverine Tunnel." As originally conceived, the line would operate with diesel-electric propulsion, and each tunnel would be equipped with a complex curtain and fan-based ventilation system to ensure adequate air temperatures and quality for both the health and safety of the train crews and to maintain diesel engine prime mover performance. The cost of the ventilation system for the two tunnels was estimated at \$18.1 million. After visiting similar curtain-based tunnel ventilation systems at the Flathead Tunnel in Montana and Moffat Tunnel in Colorado, concerns were raised that the systems could not provide adequate ventilation to meet BC Workers' Compensation Board regulations. An alternative to ventilation was to operate electric trains through the tunnels, leading to the eventual decision to electrify the new branch.

As background, in 1968, BC Rail conducted a study of electrifying their existing mainline between North Vancouver and Prince George. The study indicated that the cost of diesel fuel relative to electricity would need to more than double relative to 1968 levels to produce sufficient operating cost savings to justify the cost of capital investment.

In 1975, when the line to the new coalfields in northeastern British Columbia was first proposed, electrification was considered but rejected. The two main reasons for this were: 1) the increased cost of rock excavation required for electrical clearances (later found to be erroneously based on outdated wire heights and clearances used on legacy electrification systems in the northeastern US); and 2) the lack of any convincing modern electrification data related to operation of heavy coal trains in mountainous territory. The latter point was addressed several years later when the Navajo power plant constructed a 78-mile electrified rail line to haul coal in Arizona. The Navajo project also introduced the technology of 50 kV OCS electrification that would be critical to supporting operations on the new BC Rail line.

In 1981, the concept of electrifying the new Tumbler Ridge Branch line returned to the forefront as a means to eliminate the tunnel ventilation concerns. An initial study examined electrifying only the tunnel segments for use by dual-mode locomotives (DMLs) capable of operating on OCS and diesel. However, the railroad found that the fixed cost of the necessary electrical substations and power feeds at each of the two tunnels could substantially support electrification of the entire branch line. Full electrification of the branch, at a cost of \$20.9 million

(\$160,000/km, or \$258,000/mile), was the alternative BC Rail found that maximized the overall ROI. In addition to eliminating the \$18.1 million cost of the tunnel ventilation system, additional returns came from the cost advantage of the local inexpensive hydroelectricity relative to diesel in the early 1980s (estimated at \$2 million savings per year), and the reduced maintenance costs of electric locomotives relative to diesel. Further, the cost of seven electric locomotives required to operate the line was \$18 million, only \$1 million more than the 11 diesel-electrics that would have been purchased new to cover branch line operations. An additional economic consideration in favor of electrification was the availability of funding from Federal/Provincial Conservation and Renewable Energy programs to support the project. Given these factors, BC Rail decided to electrify the new line in mid-1982.

2.4.2 Factors that Led to Electrification

In examining this decision to electrify the new line, several factors must be considered to place the outcome in its proper context. The project involved new construction in a relatively remote area with few highway and utility corridor interfaces. Hence, the railroad designed and constructed all the infrastructure with the structural requirements and clearances of electrification in mind; there was no need for costly modifications to existing civil infrastructure like highway overpasses and bridges. In addition, the branch line did not have an existing signal and control system and/or track circuits that required costly modification to support 50 kV AC electrification. The expansion of the 230kV electrical transmission system required to support the new mining development also served the purposes of the railway electrification, helping to distribute this transmission cost over various aspects of the project, and not against the electrification option alone. Further, the tunnel ventilation system necessary in the absence of electrification also required substantial electrical connections to power fans at each tunnel, reducing the incremental cost of electrification.

2.4.3 End of Electric Operations

Electrified operations on the Tumbler Ridge Branch ended in 2000. After the initial 15-year mining contracts expired in the late 1990s, coal traffic volumes on the line declined considerably from six trains per day to less than one train per day. With less traffic, diesel-electric locomotives could shuttle shorter coal trains over the branch without causing substantial exhaust build-up in the tunnels. BC Rail's use of more efficient high-horsepower locomotives that produced less exhaust emissions compared to the lower-horsepower and less efficient diesel locomotives for which the tunnel ventilation systems were conceptualized in the late 1970s further reduced exhaust concerns. With diesel-electric operation now feasible, the non-standard electric locomotives and ongoing maintenance cost of the electrification infrastructure could be eliminated by curtailing electrified operations.

2.5 Union Pacific (1980)

Union Pacific (UP) conducted the last known major Class I railroad electrification analysis of the time, examining mainlines primarily in Wyoming, Nebraska, and neighboring states. While the studies identified high rates of return – more than 30 percent for some of the corridors – the high risks identified in the project incentivized the railroad to ultimately invest in different opportunities. The studies noted that, especially in the case of electrifying further toward Los Angeles, future environmental considerations might make electrification more feasible either through incentives or regulations.

The studies examined multiple means of reducing risk, but still deemed the overall risk too high. Researchers have identified several additional modern factors that would lower the project’s rate of return, such as larger trains and larger train envelopes (incompatible with the project’s proposed substation density and OCS height, respectively) that the study was unable to predict in 1980. Several technical problems raised in the study, such as how to fully utilize regenerative braking and expensive OCS construction through tunnels, could be addressed today by intermittent electrification² and partnerships with electric utility companies.

2.5.1 Detailed Overview

In 1980, UP made a study of electrification, analyzing a base case route primarily including three segments in Utah, Wyoming, and Nebraska, as shown in Figure 3. The report discussed additional extensions as far as Los Angeles.

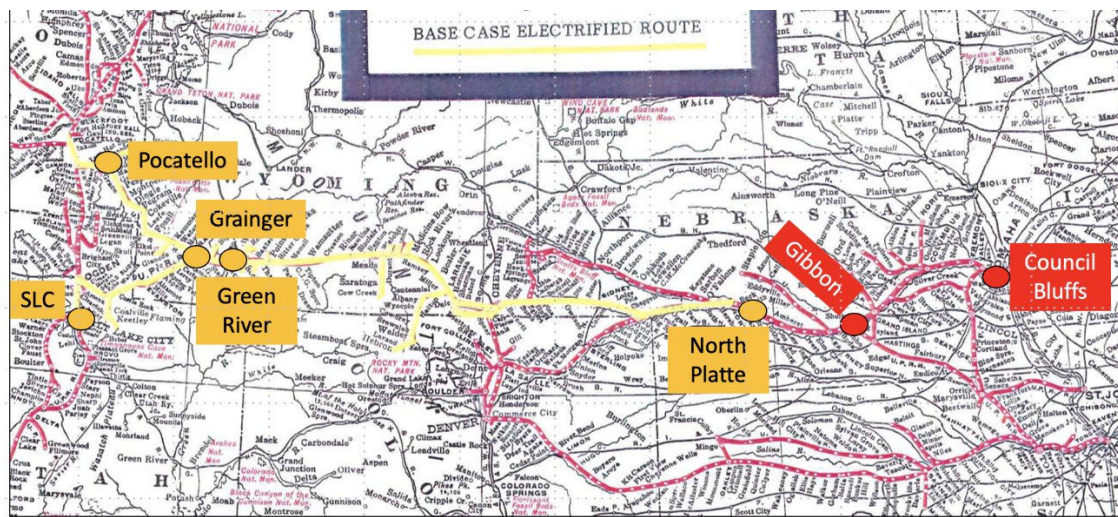

Figure 3. Extent of the Base Case Electrified Route in the 1980 UP Study

The electrification project planning and implementation was projected to take five years, 1985 to 1990 (see Figure 4), with engineering in 1985-1986, construction between 1986-1989, and locomotive procurement beginning as early as 1987. The analysis looked at the North Platte to Green River, which was the longest of the three segments, to be built first.

Table 5 summarizes the length, cost, traffic density, and expected return for each segment of the study. The similarity in costs per unit length (Table 6) for each segment might be illustrative of the level of detail reached in the analysis. A difference of only 6 percent in cost from the lowest estimate to electrify along Omaha – North Platte to the most expensive segment along Green River – Pocatello.

The North Platte – Green River segment was the primary focus of an earlier study UP conducted in the 1970s. The segment’s high rate of return, 38.8 percent, stemmed from high traffic volumes, minimal physical restrictions and branch lines, and definitive segment end points

² Intermittent electrification refers to the concept of deploying discontinuous segments of OCS along a rail corridor with trains using electric traction under the OCS and some other means of traction to bridge the gaps.

minimizing locomotive changes. The concentrated traffic and relatively simple OCS for the segment meant it was viewed as having the least amount of risk.



Figure 4. Planned Construction Timeline for the UP Electrification

Table 5. UP Electrification Analysis Segment Summary

Route	Length km (mi)	OCS Length km (mi)	Const. Costs Current \$ millions	Cost per OCS-km Current \$ thousands	Projected 1990 Traffic billion GTM	Rate of Return
Base Case	1542.9 (958.7)	4023 (2500)	\$1 913	475	109.5	31.8%
North Platte – Green River	857.6 (532.9)	2170.7 (1348.8)	\$1 010	465	83.0	38.8%
Green River – Pocatello	393.0 (244.2)	691.4 (429.6)	\$337	487	10.9	26.9%
Green River – Salt Lake City	338.9 (210.6)	853.6 (530.4)	\$408	478	15.5	29.3%
Omaha – North Platte	457.2 (284.1)	1588.9 (987.3)	\$733	461	35.7	32.0%
Yermo – Los Angeles	262.5 (163.1)	637.8 (396.3)	\$297	466	5.0	19.0%
Salt Lake City – Los Angeles	1231.1 (783.6)	2107.0 (1309.2)	\$998	474	28.0	24.8%

Table 6. Break-down of OCS Costs Per Unit Track Length for the UP Electrification Study

Category	1980 \$/km (\$/mi)	2024 \$/km (\$/mi)
OCS Material	\$39 500 (\$63 600)	\$157 000 (\$252 000)
OCS Labor	\$25 800 (\$41 500)	\$102 000 (\$164 000)
OCS Engr.	\$6 140 (\$9 880)	\$24 300 (\$39 100)
10.5% Contingency	\$6 860 (\$11 040)	\$27 100 (\$43 700)
Bonding Material	\$446 (\$717)	\$1 760 (\$2 840)
Bonding Labor	\$2 075 (\$3 340)	\$8 220 (\$13 200)
Bonding Engr.	\$237 (\$381)	\$938 (\$1 510)
10.5% Contingency	\$265 (\$426)	\$1 050 (\$1 690)
Total	\$81 300 (\$130 900)	\$322 000 (\$518 000)

The Green River – Salt Lake City segment had a lower rate of return, at 29.3 percent, but a large diesel locomotive shop in Salt Lake City meant that shifting the locomotive exchange from Green River to Salt Lake City could have some operational advantages. The primary cause for this segment’s lower rate of return was its number of tunnels, which created technical and economic challenges for OCS, and might make the segment worth revisiting in the context of intermittent electrification.

The 1980 analysis identified Yermo – Los Angeles as a segment that “...deserves closer attention in the future...” due to potential air quality mandates. The report went on to state that Yermo – Los Angeles “...may represent a potential demonstration site for electrification.” This segment includes shared operations with BNSF’s (then ATSF) Daggett – Riverside track through Cajon Pass. The longer segment from Los Angeles to Salt Lake City was considered very high risk at the time, as SP might have taken steps to shift traffic to its corridor.

2.5.2 Early Regenerative Braking Analysis

At the time of the study, there was a concern that the mountainous terrain being analyzed would at times produce more regenerative braking energy than could be dispersed in the OCS. Electric utility companies at the time were more resistant than now to accept excess power at the substations, so a solution had to be found to store the excess regenerative braking energy to achieve the maximum potential for energy savings from electrification.

UP’s study of the Los Angeles – Salt Lake City segment highlights an FRA-funded investigation into Wayside Energy Storage Systems (WESS). The concept (Figure 5) involved modified diesel locomotives with pantographs to transfer dynamic braking energy into large trackside flywheels. The ‘spun-up’ flywheels would be able to send energy to the modified diesel locomotives for tractive assistance. The WESS’s economics were favored by the heavy grades on the Los Angeles – Salt Lake City segment, which could still be utilized by modern electric locomotives.

Many of these technical challenges could be ameliorated by on-board batteries for intermittent electrification, in addition to the generally higher capacity in the electrical grid for intermittent sources of energy generation today.

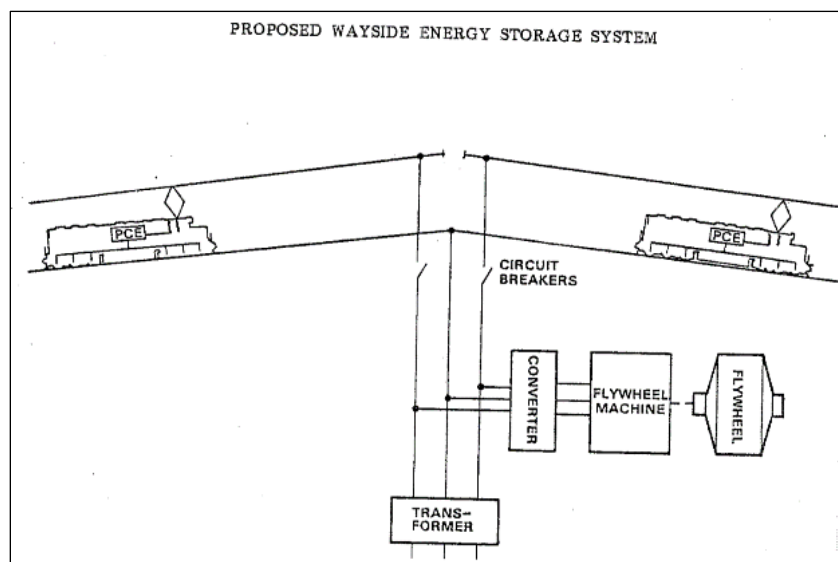

Figure 5. Concept Sketch of the Wayside Energy Storage System (WESS)

2.5.3 Emphasis on Risk Mitigation

UP's analysis looked at ways to reduce the risk of electrification. One example was the focus on first electrifying the North Platte – Green River segment, which had the highest calculated rate of return (38.8 percent), and then expanding the electrification from that initial island. The analysis suggested that this “subsegment approach” could reduce risk by treating each segment as a standalone project, and abandoning the projects where the ROI might not materialize. However, the report also cautioned that such an approach could lead to unfavorable economies of scale and extend construction schedules, lowering the overall rate of return. In contrast to North Platte – Green River, the Yermo – Los Angeles segment featured relatively low capital expenses, but it had a lower traffic base, which reduced the rate of return significantly. The report noted UP's upcoming merger with the Western Pacific Railroad (WP), and anticipated that traffic re-routing would require additional route analysis to mitigate risk.

The study performed a sensitivity analysis (Figure 6) to help determine which factors contributed the most to the project's overall ROI.

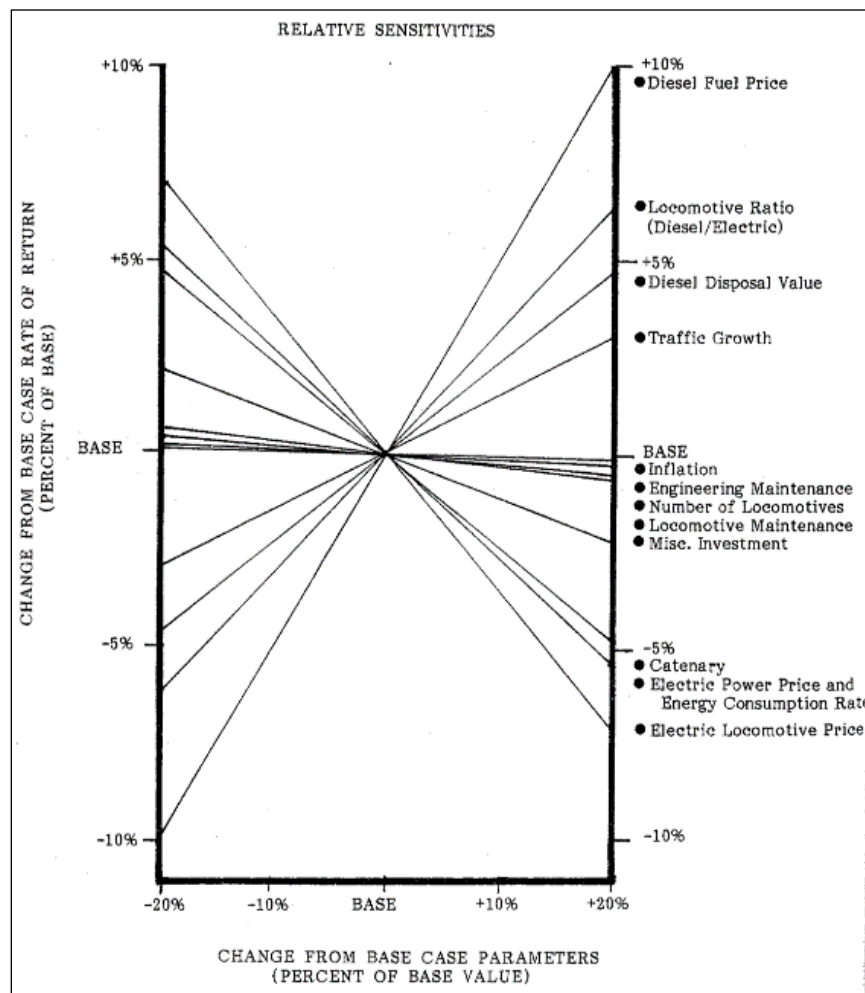

Figure 6. UP Study Sensitivity Analysis

To make a final risk assessment, UP's study then further distinguished between predictability and controllability to determine which factors contributed the most to the project's overall risk.

For example, electric locomotive price had a high influence on the project’s ROI, but also high predictability and controllability through contracts and original equipment manufacturer (OEM) relationships, therefore producing relatively low risk. The price of diesel fuel, in contrast, had a high influence while also having low predictability or controllability, therefore producing high project risk. Table 7 shows the UP-study’s risk assessment results, which categorized the relative price between diesel and electricity and the energy consumption ratio as the highest sources of risk.

Table 7. Qualitative Risk Assessment in UP’s Electrification Study

Category	Sensitivity (+)	Predictability (-)	Controllability (-)	Risk
Diesel Fuel Price	High	Low	Low	High
Electric Power Price	High	Medium	Medium	High
Energy Consumption Ratio	High	Medium	Medium	High
Ratio of Diesel to Electric Locomotives	High	Medium	High	Medium
Catenary Investment	High	Medium	High	Medium
Diesel Disposition Value	High	Medium	High	Medium
Traffic Growth	Medium	Medium	Medium	Medium
Electric Locomotive Price	High	High	High	Low
Miscellaneous Investments	Medium	Medium	High	Low
Locomotive Maintenance Ratio	Low	Medium	High	Low
Number of Locomotives	Low	High	Medium	Low
Engineering Maintenance	Low	Medium	High	Low
Inflation	Low	Medium	Low	Low

2.5.4 Assumptions on Train and Locomotive Power

Like other electrification studies of the time, UP’s electrification analysis assumed electric locomotives would have more power and tractive effort than diesel locomotives, assuming a need for 9.10 diesel locomotives per billion GTM, compared to only 3.48 electric locomotives.

The OCS in UP’s study would have been designed to support 13 MW (18,000 hp) locomotive consists with trains spaced every 16 km (10 miles). This was the equivalent of three electric locomotives at the time. Since then, freight cars have grown from 132 gross tons to 143 gross tons, trains have become longer and heavier, and distributed power locomotives have allowed for trains more than 22 MW (30,000 hp). This points to a risk that was not considered in the 1980 study, despite the study’s emphasis on risk avoidance: the designed substation density (one substation every 71 track-km, or 44 track-mile) would not support modern train and locomotive consists.

The report did note the potential need for higher substation densities at locations where trains might “bunch.” This points to the need for accurate route simulations to identify train operation parameters and variations. Electrified freight railroads typically have two effective dispatch entities: train dispatchers to control traffic and “power dispatchers” to monitor and control OCS power demand and usage. Overall, the study assumed that electric utility companies would assume responsibility for the long-term maintenance of transmission lines and substations, with UP charged for electrical energy at the substation outputs.

2.5.5 OCS Design

Because the UP study was the last major electrification study by one of the Class I railroads, it is worth exploring the specifics of some of the study's design parameters for the OCS. Figure 7 below shows the typical OCS cross section along tangent track.

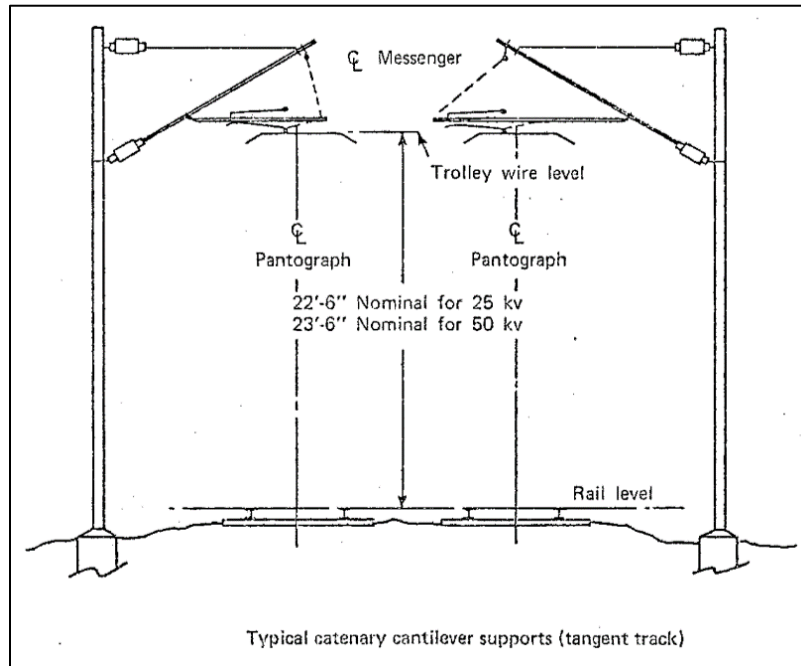

Figure 7. Typical Catenary Cross-section from UP's Electrification Study

Notably, this cross section would not provide an adequate voltage gap distance for double-stack intermodal container cars,³ which began operating over UP's network in 1982, two years after the railroad's electrification study concluded. This was another risk that was not identified at the time.

2.6 Federal Railroad Administration (1983)

The most recent detailed and extensive public study of large-scale US freight rail network electrification using corridor-specific information was conducted for FRA by the US Department of Transportation (DOT) Transportation Systems Center (TSC) in 1983 (Spenny & Mott, 1983). This effort followed an initial FRA feasibility study in 1974 (that was also examined by the United States Railway Association in 1975) and a follow-up study of average costs in 1977 (subsequently updated in 1980). In the 1983 TSC study, a model was used to analyze the economics of a 46,670-km (29,000-mile) electrified freight rail network involving 16 different freight railroads. For the base case, the study concluded that the economic advantages of electrification over diesel operation were substantial on many route segments, with 60 percent of the studied network achieving a rate of return greater than 15 percent, and 28 percent achieving a

³ AAR's Clearance Plate H puts the maximum height for a double-stack intermodal rail car above top-of-rail at 6.45 m (21'2"), leaving a clearance of only 41 cm (25 kV) to 71 cm (50 kV) (16" to 28") with the cross section in UP's study.

rate of return exceeding 20 percent. The considerable variation in rate of return between route segments was found to be heavily influenced by traffic density, the type of diesel locomotives being replaced, type of electric locomotive, dispatch policy, catenary cost, and differential cost of fuel compared to electricity. The study further explored various tri-party (i.e., railroad, utility, and external) financing structures to minimize the railroad share of the capital investment and debt resulting from implementing the project. Although the overall rate of return was substantially greater than that predicted by previous FRA studies, it was left to individual railroads to initiate more detailed studies of route segments that showed favorable rates of return, with additional Railroad Electrification Assessment Model (REAM) analysis suggested as one approach to further refine the scope of work of these railroad-specific studies.

2.6.1 Study Methodology

Multiple Class I railroads participated in the 1983 TSC study. To improve upon the previous 1974 and 1977 studies (and their subsequent updates) that were based on average costs and typical route characteristics, the 1983 study aimed to conduct a more in-depth analysis that considered the effect of route-specific factors. To achieve this goal, the study team developed the REAM to evaluate large-scale electrification of the US rail network. The model was a differential, discounted cash flow analysis based on identical traffic, freight rates, and quality of service for diesel and electric propulsion. No consideration was given for changes in traffic levels due to differing service levels under electrification. The model calculated an internal rate of return given the total cost of electrification, regardless of the source of funds used to implement the project.

The study identified a network of 46,690 route-km (29,000 route-miles) consisting of 96 route segments belonging to 16 different railroads (Figure 8). Each link carried, at a minimum, 30 MGT of traffic in 1978, with a core 16,100 route-km (10,000 route-mile) network carrying 40 MGT. Specific routes were selected to connect major operating centers and make the electrified segments on a given railroad cohesive from an operating perspective.

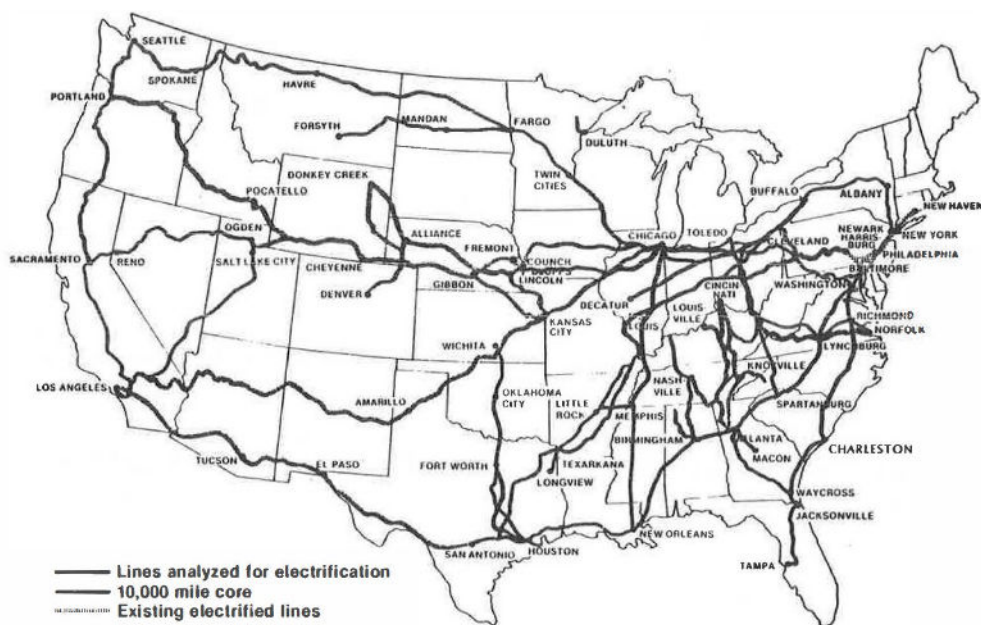

Figure 8. Hypothetical 29,000-mile Rail Network Analyzed in the 1983 TSC Study for FRA

In conducting the analysis, the percentage of traffic hauled by electric locomotives on a given segment varied from 50 to 100 percent depending on the amount of traffic moving to and from non-electrified lines at intermediate points. For purposes of the REAM analysis, rail traffic was aggregated into four train types: bulk commodity unit trains, normal (mixed freight or “manifest”) trains, expedited trains (intermodal and perishables) and passenger trains.

For motive power, the study compared 3,000 hp diesel-electric locomotives with 18 percent adhesion to 6,000 hp electric locomotives with 25 percent adhesion. Electric locomotive purchase costs were assumed to be 75 percent higher per unit than the replacement diesel-electrics offered by manufacturers at the time. The study noted that while 6,000-hp electrics offered advantages for normal and expedited trains, unit trains would ideally require a 4,000-hp electric to take full advantage of its tractive effort and power capabilities in heavy haul service. In total, the study network assumes that 2,150 electric locomotives replaced 4,873 diesel-electrics.

The model assumed that half of the required electric locomotives be purchased when the route is 50 percent electrified to operate one half of the route length. The impact of the resulting intermediate locomotive changes on operations was not considered. The remaining electric locomotives would be purchased when the remainder of the route was electrified and full electric operations begin on the entire route.

To determine the timing of infrastructure and locomotive cost outlays, the base case rate of catenary construction was limited to 1,600 route-km (1,000 route-miles) each year. The initial project schedule assumed that each year, the 1,600 route-km (1,000 route-miles) per year was constructed by six different teams working simultaneously across the network. Overall project construction was assumed to start in 1982 and be complete in 2010. To support the electrification, the study estimated that 3,840 km (2,386 miles) of new transmission lines would need to be constructed.

2.6.2 Cost Assumptions

Based on 1978 traffic levels with annual growth rates specified by the railroads, the study estimated that by 2010, the 46,670-km (29,000-mile) electrified freight rail network would consume 30 million MWh/year, compared to 2.2 billion gallons of diesel fuel. The costs of electricity were assumed to increase by 2 percent/year and diesel fuel by 3 percent/year over the first 18 years of the study period, with no further escalation after the year 2000.

Catenary cost alone for the 46,670-km (29,000-mile) network was estimated at \$7.6 billion in 1980 dollars (\$30.75 billion today), or approximately \$262,000 per mile (\$1.06 million per mile, or \$657,000 per km today). Transmission line installation was estimated at \$200,000 per mile (\$502,000 per km or \$809,000 per mile today). The cost of clearance modifications for overhead highway bridges and railroad through-truss bridges was estimated at \$50,000 per instance (\$202,000 today) to represent an average of reference costs estimated for previous study of 25 kV and 50 kV catenary installations. It was estimated that 65 percent of overhead bridges would require reconstruction to provide adequate clearance. Tunnel modifications to increase clearances by two feet were estimated at \$1,400/foot for single track tunnels (\$18,600/m or \$5,700/foot today) and \$2,480/foot for double-track tunnels (\$32,800/m or \$10,000/foot today). Signal modification costs of \$100,000 per route-mile (\$252 per route-km or \$405,000 per route-mile today) were used to represent the expected cost for corridors with typical DC signaling and

trackside communication lines. Additional allowances were made for routes with cab signals and other more complex signal systems. It was assumed that this cost included required modifications for train-activated highway-rail grade crossing warning circuits.

2.6.3 Costs, Benefits and Rate of Return

Total catenary, substation, and transmission infrastructure, plus signal and civil infrastructure design and construction costs were estimated at \$15 billion (\$61 billion today) for the 29,000-mile network. An additional \$3.6 billion (\$14.6 billion today) was required for purchase of electric locomotives, although this amount was entirely offset by a credit from diesel-electric locomotive purchases that would be avoided by purchasing new electric locomotives instead. Operations would save approximately \$800 million per year on energy costs based on the projected price spread between electricity and diesel fuel (\$3.2 billion/year today), and save an additional \$1 billion per year in locomotive maintenance (\$4 billion/year today). No other benefits of electrification were considered.

Over a 56-year analysis period (1980-2036), the rate of return for the 29,000-mile network calculated by REAM was 19.4 percent, and 25.5 percent for the 10,000-mile core network with the greatest traffic densities.

The base case assumed that railroads would be responsible for the cash outlay required for all facets of the project, except for the catenary, substations, and utility connections. The cash outlay for catenary was assumed to be 25 percent railroad funds and 75 percent financed by an external source. The cash outlay for substations was assumed to be split evenly between railroads and utilities. The cash outlay for utility connections was assumed to be entirely from utilities. The external funding source and utilities were assumed to be repaid by the railroads over a set number of years with a specified interest rate and repayment schedule, either a uniform schedule or payments proportional to railroad electric energy consumption.

Under this arrangement, the peak cash outlay by the railroads was determined to be approximately \$2 billion (\$8 billion today). The initial benefits of electrification would not balance the outlay since most of the cost reduction was absorbed by annual payments for the external financing and to the utility. However, as the electrification of the network was expected to proceed, railroad capital expenditures would decrease, and 10 and 20 years after the start of the project the payments would cease for utility investment and external financing, respectively. After the end of those payments, the railroad would experience rapid and sustained increases in net cash flow.

As detailed in the next section, the study examined other financing scenarios with more of the project financed externally and a case with all investment handled directly by the railroad with minimal contributions from the utilities. These different arrangements did not influence the rate of return, but greatly impacted the pattern of railroad cash flow calculated by REAM. In the case with no external funding, the peak railroad cash outlay rose to approximately \$3.3 billion, a 65 percent increase compared to the \$2 billion base case with 75 percent of catenary construction financed from external funding (\$13.4 billion versus \$8.1 billion in modern dollars).

2.6.4 Sensitivity Analysis and Limitations

Like the UP study discussed previously, the TSC study for FRA leveraged REAM to conduct a sensitivity analysis (Figure 9). The rate of return was found to be heavily influenced by traffic

density, the type of diesel locomotives being replaced, type of electric locomotive, dispatch policy, catenary cost, and differential cost of fuel compared to electricity.

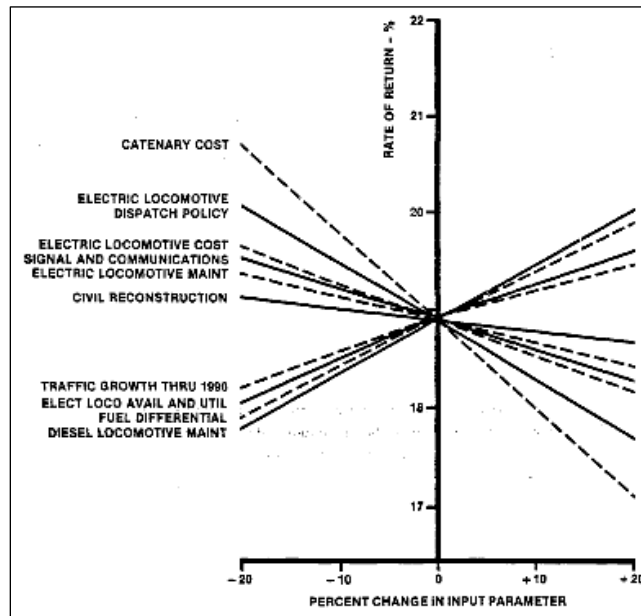

Figure 9. Sensitivity of Electrification Rate of Return to REAM Input Factors

Given these sensitivities, the base-case rate of return decreased from 19.4 to 14 percent when it was assumed that the relative costs of diesel fuel and electricity would remain constant, as opposed to the steady increase in cost differential resulting from the assumed 2 percent annual increase in electricity costs compared to 3 percent annual increases for diesel fuel.

The study report noted several limitations in the REAM analysis. First, it was difficult to obtain an exact count of bridges and tunnels with insufficient clearances, impacting the civil construction cost estimate. Second, a more detailed estimate of the relative maintenance costs of both diesel-electric and electric locomotives was needed to refine estimates of those benefits. Finally, a more detailed estimate of the cost of electric locomotives consistent with the types of production levels needed to support the overall network and a rate of acquisition matching the rate at which route segments are electrified was needed to improve the analysis.

2.6.5 Financing Arrangements

One of the report appendices elaborates on the rationale for the base case infrastructure cost allocations described above. In doing so, the study noted that railroads were not receptive to any financing/ownership alternatives that required reflection of significant electrification-related debt on their balance sheet. Thus, a funding corporation was considered for providing a large part of the necessary capital for the initial electrified network catenary construction, and to assume the “risk of ownership” that comes with the OCS. The funding corporation would be structured on the assumption that it would anticipate capital recovery plus reasonable interest through a rental charge per kWh of electricity used by the railroads. In addition, the study suggested that tax incentives be considered to encourage participation by the railroads.

To reflect these requirements, the study specifically outlined three key financing objectives:

- Avoid reflecting any related debt on the balance sheet of participating railroads.
- Structure the transaction to provide maximum tax advantages to the railroads as incentive for participation.
- Possibly provide for the transfer of ownership of the electrification system to the railroads after the funding corporation has recovered its investment and reasonable return.

To meet these financing objectives, four different electrification infrastructure financing models were proposed:

- Federal loan guarantee to individual railroads for construction
- Ownership by FRA with rental charges to the railroad under a financing or operating lease
- Formation of a “joint venture” with nominal railroad investment, specifically with FRA as the general partner with 100 percent financing/loan guarantee, and the railroad as a limited partner in the joint venture
- Ownership through a separate corporate entity that was 100 percent owned by participating railroads, and with that corporation having a 100 percent loan guarantee by FRA for financing construction of the project – The corporation would subsequently enter into operating lease agreements with individual railroads with a rental charge based on kWh of electricity consumed. The railroads would pay all costs related to operating and maintaining the electrified network. Operating rents received by the corporation would be used to meet its interest and debt retirement obligations assuming all financing and operating costs would be covered over a 20-year period. At that point in time, the network could possibly be transferred to the individual railroads for their equity investment.

Of these four options, the study suggested that the formation of a joint venture with FRA or ownership through a separate corporate entity warranted the most consideration and further evaluation. However, the study also cautioned that these options were only preliminary concepts for discussion and identification of directions for further analysis. Inclusion of these concepts in the study were not meant to imply that the railroads, utilities, and external financing parties (including FRA) had entered any negotiations to form such agreements or entities.

2.6.6 Outcomes

The 1983 TSC study for FRA demonstrated that large-scale freight rail electrification could yield favorable rates of return, and suggested that alternative financing arrangements could mitigate railroad concerns regarding taking on the debt and risk associated with construction of electrification infrastructure. Although the financing discussion suggested that a large FRA or government program would be required to coordinate and provide the necessary loan guarantees, the study left it to individual railroads to use REAM to conduct further, more detailed studies of prospective electrified freight rail corridors.

Unfortunately, without further FRA coordination, there is no public record of individual freight railroads conducting these detailed follow-up studies, and little study of freight rail electrification

in general over the next decade. There are many reasons for this gap, including political changes, post-deregulation restructuring of the railroad industry through multiple mergers in the 1980s, an evolving shift in FRA focus away from railroad development to primarily safety, increasing railroad fuel efficiency through advances in diesel-electric locomotive technology, and, most importantly, the end of the oil crisis and increasing concerns regarding the long-term safety and environmental impacts of nuclear and coal-fired power plants that had been viewed as sources of low-cost electricity to support railroad electrification. While the 1983 TSC study for FRA was based on a projected steady increase in the price of diesel fuel and a widening gap between the relative cost of diesel and electricity, the cost of diesel fuel began a steady decline even before the study was completed. Without an energy cost benefit, there would be little incentive for freight railroads to continue studying electrification.

Although the 1983 TSC study for FRA marked the end of one era of freight rail electrification studies, the innovative financing arrangements it presented, echoing those considered by SP through Catenary Associates and SR and L&N with the TVA, still serve as a potential model for financing modern options for freight rail electrification.

2.7 Other Notable Studies

To reinforce the themes emerging from the electrification case studies presented in the previous sections, two additional studies are of note: the 1970 Edison Electric Institute study of railroad electrification, and the 1977 Canadian Railway Electrification Study.

2.7.1 Edison Electric Institute (1970)

In 1966, the Edison Electric Institute (EEI) appointed a committee to investigate the technical and economic feasibility and potential problems associated with railroad electrification in the US (Edison Electric Institute, 1970). The work of the committee was published in a multi-volume report in 1970. This noteworthy study was conducted by a coalition of electrical utilities for the power industry, and provides insights into the motivations and perspective of utilities on railroad electrification at the time. Increased sales of power and energy are cited as the primary motivation for electric utilities. EEI noted that, at the time, the railroads possessed 45,000 MW of generating capability in the form of diesel-electric locomotives, making them the largest non-electric utility power provider in the US. This load was equivalent to over one-half of all non-utility “private” power produced annually, presenting electric utilities with an unprecedented opportunity to gain a sizeable new market.

Consistent with its utility perspective, the EEI report focuses on the technical aspects of power supply for railroad electrification, and how new technology was eliminating past obstacles. The report notes that US freight rail electrification stopped expanding in 1938, coincident with the advent of the diesel-electric locomotive for mass-produced mainline service. The use of diesels changed the economics of railway electrification, with power supply being one costly obstacle. The 25 Hz AC and DC electrification systems implemented by railways could not be supplied directly from three-phase 60 Hz AC commercial electric power, but instead required combinations of rectifiers, motor-generators, and rotary frequency converters to connect the traction power supply system to the commercial electric grid. The costs of owning, maintaining, and operating this specialized equipment increased mainline railway electrification costs to the point that there were no economic advantages relative to diesel propulsion. Additional historical concerns were noted regarding the ability of commercial utility providers to supply single-phase

power without creating imbalances in the system that diminish power quality to the detriment of other customers and the overall system stability.

The development of rectifier-type locomotives capable of operating off 60 Hz AC commercial power stepped down to the proper voltage with a transformer eliminated the need for rotary frequency converters and enhanced the economics of electrification. Concerns regarding phase imbalance were also mitigated over time as individual electrical utilities grew with increased capacity and strong interconnections. To demonstrate these advancements, in 1969, the American Electric Power Corporation (one of the entities serving on the study committee) constructed the Muskingum Electric Railroad to transport coal 15 miles in Ohio using 25 kV 60 Hz AC electrification, becoming the first electrified railroad in the US to operate on commercial frequency. The Muskingum operation was also notable for its use of automated trains on the isolated mine-to-power plant line.

The EEI report also observes that the railroad mergers of the 1960s consolidated more traffic on fewer routes, and innovations such as intermodal equipment were drawing traffic from trucks to rail. Both trends would increase traffic density on a smaller network of key corridors, improving the economics of electrification on these routes. To provide context for its analysis, the report studies the specific case of electrifying the “high density” route between Harmon, NY, and Cleveland, OH, a 600 mile length then operated by the New York Central Railroad (and merged into the Penn Central during the study). EEI concluded that railroads may see savings in operation and maintenance expenses on corridors where traffic density is high enough to support the capital investment.

While the EEI study covered many of the same costs and benefits discussed in previous sections of this report, some important conclusions were also made:

- Electrified railroad load is desired from a utility perspective, but the supply of a mobile load of a single customer by multiple electric utilities poses tariff and legal complexities that had yet to be encountered in the US.
- Although electrical loads from moving trains can be a challenge from an electricity dispatching perspective, the substations feeding the study corridor had an annual system load factor of 74 percent and, in most cases, peak loads did not directly coincide with the peak demand periods of individual utilities.
- While 50 kV is likely to be the most economical voltage on many corridors, 25 kV and 12.5 kV may be required where it is not economically feasible to obtain additional clearances through tunnels and under overhead bridges.
- The utilities favored wood poles for support of the OCS where guying⁴ was not a problem.
- A major deterrent to electrification is financing for the OCS and wayside substations, which the railroads may want the utilities or a third party to finance. From a utility perspective, the carrying charge of this investment is of comparable significance to the cost of generating the power itself.

⁴ Guying is a technique used to strengthen and stabilize trees, poles, or other structures by attaching guy wires or braces to them.

- Electrification provides diversity in the ultimate power source as five types of fuel/sources were currently in use as the prime energy for electric power systems, while railroad operations were entirely dependent on diesel fuel. The ability to hedge different power sources offers economic advantages, and not being tied to a single source offered protection against national emergencies when the supply of diesel may be interrupted or curtailed.
- With growing concern over environmental quality and increasing demands for more effective controls in combustion processes, electrification may provide railroads with an opportunity to concentrate fuel conversion and air pollution control at a smaller number of points where more efficient and effective control procedures may be implemented compared to providing such measures on each individual locomotive.
- Electrification would have civic and social value by providing cleaner, quieter, pollution-free operation. These intangibles are particularly important in densely populated areas and must be factored on top of a purely economic analysis.

It is interesting that several of these latter points made by EEI (utility partnerships, energy diversity, environmental quality, and social benefits) foreshadow the modern context for evaluating the costs and benefits of freight railroad electrification. The conclusion ultimately made in the EEI study was that the technology and economic advantage of railroad electrification was at hand, but a joint venture between a railroad and utility was needed to move forward with implementation.

2.7.2 Canadian Railway Electrification Study

In 1977, at a Transportation Research Board conference entitled “Railroad Electrification: The Issues,” the Canadian Institute of Guided Ground Transport presented a paper summarizing Phase 1 of a Canadian Railway Electrification Study (Corneil, 1977). The study was convened to examine the technical and economic aspects of railway electrification, and determine potential timeframes and required programs of investigation, research, and development required to electrify significant portions of the Canadian railway network.

The paper presents costs and benefits of 50 kV electrification across an example 650-km (400-mile) track segment and demonstrates a positive incremental present value (IPV). The positive IPV is used to justify a larger plan to implement electrification on 15,300 km (9,500 miles) of track across the Canadian rail network over a 30-year period.

Key to the proposed electrification plan was the recommendation to develop an actual 650-km (400-mile) prototype installation on existing main track and operate it for a period of five years to validate and reduce the uncertainty in many of the cost and benefit assumptions. Such a program would help reduce the risk of the larger nationwide electrification program.

The study noted that although a positive IPV indicates that investment in electrification may be economically attractive at reasonable traffic levels, it may not be commercially attractive. The study further cautions that the required capital commitment for the larger electrification program may be “a dangerously disproportionate burden if traffic drops or any one of a number of other factors becomes adverse.” In exchanging the variable cost of fuel for the fixed cost of electrification infrastructure, the costs are immediate and relatively definite, but the benefits are

distant in time and subject to great uncertainty, creating tremendous risk and corporate vulnerability for railroads making the required investment.

To balance this risk, the study observes that the benefits of electrification will not be derived solely by the railways, but offers other national and economic benefits such as reduced reliance on foreign oil and job creation during the 30-year construction of the system. While these positive outcomes may be in the national interest, if influencing factors such as traffic levels and relative energy costs do not match projections, electrification may prove unprofitable to the railway enterprise making the investment.

3. Commonalities Between Past Studies

This section breaks down several topics where the case studies in the previous section overlap, and provides possible common reasons many past electrification plans did not move forward.

3.1 Change in Environmental Focus

In the various studies of the 1970s and 1980s, reductions in petroleum consumption were the primary motivation behind electrification, generally due to energy security rather than a desire to reduce emissions. At the time, the general assumption behind electrification was that the electricity would be provided by coal-fired power plants.

There were some notable exceptions:

- SP's reports called out the potential environmental benefits of electrification, explicitly mentioning reductions in emissions potentially being important in the future.
- The Cincinnati – Atlanta electrification proposal, which was primarily driven by the public TVA rather than by the private SR or L&N, did mention environmental motivations, although it still considered energy security as a larger benefit.
- UP's 1980 study mentions emissions benefits for the segments going into Los Angeles. However, this was likely related to local air quality issues in Southern California as opposed to decarbonization to prevent global climate change.

From these examples, the research team found that while emissions were not a primary concern, railroads and related stakeholders were peripherally considering emissions reductions. While emissions reduction was not the primary or secondary motivator behind potentially electrifying railway operations, multiple studies specify that future environmental incentives or regulations might provide the necessary motivation to electrify.

3.2 Network Effects

UP's 1980 study and TVA's partnership with SR and L&N both suffered from network effects. "Network effects" is the property of electrification whereby OCS electrification becomes more useful as greater proportions of the railroad network are electrified. This means that, without a very large capital outlay to electrify a significant portion of a railroad network, electrification will initially have limited usefulness to many planned train runs involving origins or destinations outside the electrified territory, and therefore a limited rate of return. For example, TVA's initial approach seems to indicate that the organization was interested in electrifying only one of SR's or L&N's Cincinnati – Atlanta mainlines, with the hope that a track sharing agreement could be reached with the other railroad (McClellan, 1978). Upon learning that the lack of connections and lack of capacity would make such an agreement unfeasible, TVA decided to split its limited capital between both railroads, and neither mainline was electrified.

UP accounted for the network effect by planning to build-out the densest segment first and then expanding outward. This approach reduces the risk of the electrification investment while increasing the risk of potential construction delays and lowering the overall rate of return.

3.3 Room for Partnerships

The primary driver in nearly every past electrification study was the price differential between diesel fuel and electricity for motive power. In spite of the volatility between the two energy prices, many railroads chose not to electrify because the risk was considered too high. Among the case studies examined in greater depth in [Section 2](#), this was explicitly the case for the SP studies, TVA’s REDP, and the UP study. In the case where electrification occurred (BC Rail), and the cases where electrification was closest to occurring (TVA or SP), the railroads were able to create partnerships with the electric utility companies. The conclusion is that railroads want assurances on electricity prices, and utilities want ROW for new transmission lines.

Multiple examples have shown that co-locating electric transmission lines with rail corridors makes rail electrification easier to implement. For example, the new transmission lines to power the mine for the Tumbler Ridge subdivision substantially lowered electrification costs, and SP found that ROW sharing could make electrification more feasible for multiple corridors. Meanwhile, the utility’s transmission lines could be built with less uncertainty over ROW procurement. The TSC study for FRA suggested ways to formalize partnerships between railroads and utilities to help spread the initial capital outlay over multiple parties to reduce debt and risk burden on the railroads.

The need for ROW for electric distribution remains. A study published by the National Renewable Energy Laboratory (NREL) in 2022 shows that, to achieve a fully carbon neutral energy grid in the United States by 2035, approximately 21,000 to 146,000 km (13,000 to 91,000 miles) of new high-capacity transmission lines must be built (Denholm, Brown, & Cole, 2022, p. 45). Those transmission lines will be necessary to transmit power from wind or solar rich regions to where energy is demanded in cities, and to balance loads across the grid as the percentage of less predictable renewable energy increases. The regions requiring new transmission lines, as shown in [Figure 10](#) from the NREL study, already contain substantial rail ROW (Denholm, Brown, & Cole, 2022, p. 50).

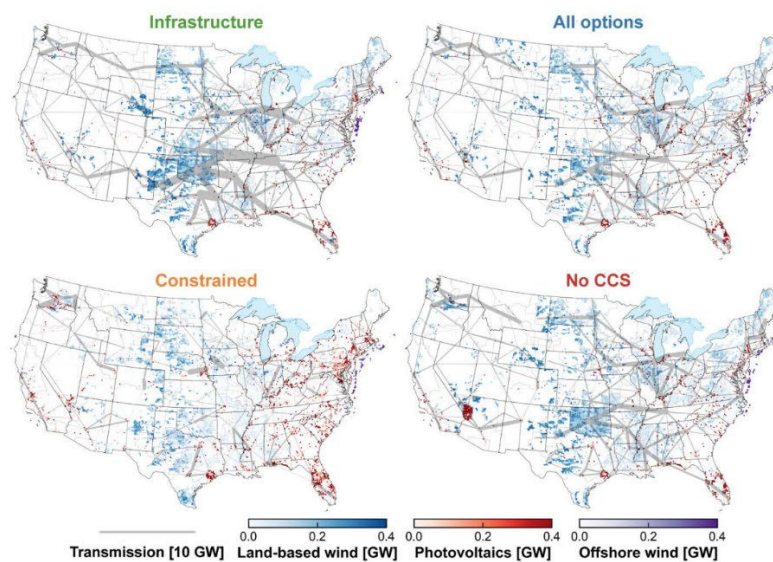

Figure 10. New Energy Generation and Transmission across Four NREL Scenarios (Denholm, Brown, & Cole, 2022)

Innovative partnerships (e.g., the Catenary Associates entity proposed for SP's partnership with multiple southwestern utility providers, the REMC between SR, L&N, and the TVA, or the various triparty arrangements conceptualized in the TSC study for FRA) could show a path forward for railroads and utility providers to work together on future electrification projects.

3.3.1 Importance of Communication Between Stakeholders

SP's work with SCE and other utility providers, as well as TVA's work with SR and L&N, illustrates the importance of clear lines of communication between the railroads, the utility providers, and other stakeholders for an electrification project. SP's initial studies of electrification in Oregon suffered from misunderstandings between the railroad and the electric utility. The railroad had unreasonable expectations about electric dispatching and pricing, and the utility had unreasonable expectations about railroad train scheduling. As SP performed more studies in the electrification space, it developed better relationships with the utility companies.

SR and TVA had clear communications from the beginning, and TVA approached the partnership by first seeking clarification about SR's and L&N's needs. Clear communication provides guidance for future electrification efforts to get off to a faster start, and may sustain a project through to full electrification.

3.4 Competing Investment with Mergers

Because railroads operate as businesses, they will opt for the investment most likely to provide the highest rate of return. During the period that freight rail electrification was initially being considered, electrification studies repeatedly showed strong positive returns on investment, but changes in the regulatory environment of the time made railroad acquisitions and mergers a less risky option for the available capital. Mergers appear to have removed momentum for SP's electrification initiatives, TVA's partnerships with SR and L&N, and for Conrail's electrification plans. UP's electrification study counseled caution over the results of its segment analysis due to the forthcoming merger with WP, and the likely changes in traffic patterns that would ensue. Mergers also likely tempered any railroad-specific follow up to the TSC study for FRA.

As electrification is considered in the future, it will be compared against alternative investments, such as spur lines to serve new clients, or double tracking corridors to increase capacity.

3.5 Economics of Traffic Projections

Electrification studies in the past, such as those conducted by SP, Conrail, UP, and BC Rail, used traffic projections that did not fully pan out. In some cases, this was due to the broad shift away from coal. In the 1970s and 1980s, electrification was viewed as a means to move away from diesel fuel derived from foreign oil and toward electricity derived from local coal that the railroads would transport themselves. This positive feedback loop, and the overall outlook at the time of more coal reliance in the future, fueled some of the erroneous traffic projections.

Both BC Rail and Conrail responded to reductions in traffic by retiring their electric fleets to streamline their locomotive maintenance lines. This indicates that, even once electrification has been built, it could be canceled after traffic fluctuations if it does not reach a large enough threshold of the railroad's total traffic.

Moving forward, it will continue to be difficult to predict rail traffic 10 or more years in the future, and traffic density will continue to be a source of risk for decarbonization investments that rely on fixed infrastructure, such as OCS.

4. Overview of Modern Studies

This section examines some of the notable rail electrification studies performed since the 1980s, with discussion of how the study of mainline railway electrification has shifted over time.

4.1 SCRRA LA Basin Electrification Study (1992)

The Southern California Regional Rail Authority (SCRRA) helped form a rail electrification task force in 1991 to conduct the *Accelerated Rail Electrification Program*, a study examining rail electrification in the Los Angeles Basin. The SCRRA electrification study was the first major modern North American rail electrification study focusing primarily on locomotive emissions (Cogswell, 1994). The study was motivated by the intense smog in the Los Angeles basin at the time, and analyzed potential emissions reductions from converting freight and commuter rail passing through the basin.

As Figure 11 shows, this electrification analysis occurred at a time of historically low diesel fuel prices (Energy Information Administration, 2022) (Office of Energy Efficiency & Renewable Energy, 2012) (Association of American Railroads, 2022).⁵ With such low diesel costs, the railroads sought guaranteed electricity rates and assurances about time-of-day rates that the utility stakeholders could not provide. Additionally, the study had only a limited analysis of how the railroads would switch locomotives once outside the electrified territory.

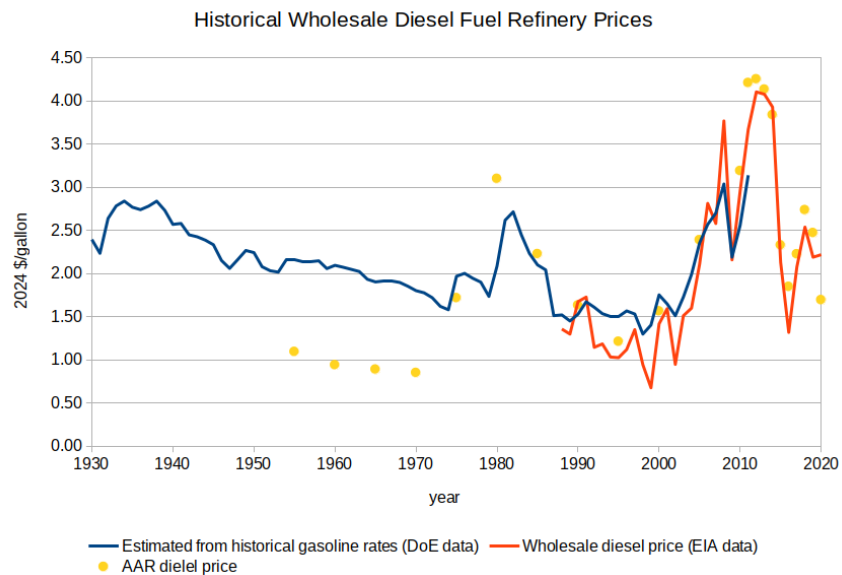

Figure 11. Historical Real Diesel Prices

⁵ The red line shows wholesale diesel prices, adjusted for inflation via CPI, from 1983 to 2022, the years for which EIA has nominal wholesale diesel prices available. The blue line shows estimated wholesale diesel prices based on historical gasoline prices published by the Department of Energy's Office of Energy Efficiency & Renewable Energy. Wholesale diesel prices should be considered indicative of, but not equal to, the prices railroads have paid for diesel.

The study assumed funding would be divided between local, state, and federal public sources, with some funds from the railroads and the utility companies. The exact size of each stakeholder share was an open question, and several financing structures were proposed in the study. A project status report for the American Public Transportation Association (APTA) in June 1992 suggested approaching the California Public Utilities Commission (CPUC) for permission to raise electricity rates in the region so that rate payers would finance up to 40 percent of the project (Jester, 1992). Some initial planning documents indicate that the railroads would only be directly responsible for 10 percent of capital costs (Southern California Regional Rail Authority, 1992).

The rail electrification taskforce recommended the electrification of 13 rail corridors, totaling 1,297 km (806 miles) of rail lines and 2,338 km (1453 miles) of track in the Los Angeles region. The electrification was estimated to cost \$3.2 billion (\$7.4 billion in current dollars), and the task force estimated that construction would have lasted at least a decade, but more likely 18 years with capital constraints. The estimated construction cost, including locomotive acquisition was \$3.1 million per track-km in current dollars (\$5.0 million per track-mile), which is higher than some of the cost estimates from past studies. Reasons for the high cost include designing the electrification to a higher-than-necessary standard, the inclusion of capital costs not related to electrification, and choosing expensive locomotives.

Despite the high cost, the study found that rail electrification would be less expensive per tonne of oxide of Nitrogen (NO_x) mitigated than other emissions strategies that had been funded. Without a dedicated funding source, however, the study never resulted in action.

4.1.1 Intense Scrutiny on Emissions

In stark contrast to the electrification projects considered in the 1960s through the early 1980s, the SCRRA study began with intense scrutiny of locomotive emissions. As emissions controls gradually reduced emissions from various sources, commuter rail studies of the time forecast that by 2010, freight rail would contribute to 93 percent of total rail NO_x emissions (Cogswell, 1994). NO_x emissions are one of the major components of smog, alongside volatile organic compounds (VOCs), and they are disproportionately produced by diesel combustion.

The study deemed electrification of local freight train service and rail yard/terminal operations impractical, but found that electrification for line haul freight and for regional (Amtrak) and commuter rail could reduce annual NO_x emissions by over 97 percent, as shown in [Table 8](#). The study noted that improvements in diesel technology would reduce local train and rail yard emissions even without electrification, but the most optimistic projection for cleaner diesel-electric locomotives was a 25 percent reduction in NO_x emissions, well short of the amount necessary to reduce overall rail emissions by 90 percent. The SCRRA study occurred before EPA promulgated its locomotive exhaust emissions standards in 1998, which created the Tier 0 through Tier 2 locomotive categories, and well before EPA's 2008 rule created the Tier 3 and Tier 4 categories (Environmental Protection Agency, 2023).

The reduction in NO_x emissions between a Tier 0 and Tier 1 switching locomotive is roughly in-line with what was predicted in the SCRRA study, but the reduction in switching locomotive NO_x emissions going from Tier 0 to Tier 4 is over 85 percent - even higher than the reductions SCRRA predicted for switching from diesel to methanol or natural gas, and high enough to meet the study's emissions targets (California Air Resources Board, 2023). Also, while locomotive

diesel technology has improved more than the SCRRA predicted, adoption rates for higher Tier locomotives are still low, with only around one fifth of locomotives in California in 2020 being Tier 3 or Tier 4, and the suitability of the cleanest locomotives for yard work is low (California Air Resources Board, 2023).

Table 8. Projected Emissions from the SCRRA 1992 Study and Calculated Emissions Reductions to Reach 90 Percent Reduction Target

	Projected 2010 Diesel Emissions in Tonnes per Year				
	NO _x	PM	HC	CO	SO _x
Line Haul Freight (diesel)	8 580	264	495	1 260	855
Local Freight (diesel)	1 298	40	84	268	136
Yard Freight (diesel)	1 182	38	98	247	92
Amtrak (diesel)	239	8	5	38	21
Commuter Rail (diesel)	643	25	11	89	52
Total (diesel)	11 942	375	693	1 902	1 156
	Projected 2010 Electric Emissions in Tonnes per Year				
	NO _x	PM	HC	CO	SO _x
Line Haul Freight (electric)					
Amtrak (electric)	253.9	9.1	35.6	56.2	3.6
Commuter Rail (electric)	1.8	0.3	0.9	1.8	0.1
Total (electric)	5.5	0.9	3.0	5.2	0.3
	Projected Reductions in Annual Emissions by Electrification				
	NO _x	PM	HC	CO	SO _x
Line Haul Freight	97.0%	96.6%	92.8%	95.5%	99.6%
Amtrak	99.2%	96.3%	82.0%	95.3%	99.5%
Commuter Rail	99.1%	96.4%	72.7%	94.2%	99.4%
Overall Reduction in Electrified Categories	97.2%	96.5%	92.3%	95.4%	99.6%
Total Reduction (assuming local and yard emissions stay the same)	77.0%	76.5%	68.0%	69.6%	79.9%
Minimum Reduction in Local and Yard Emissions to Achieve 90% Total Rail Reduction Target	62.4%	65.1%	83.6%	75.3%	51.1%

The study’s focus on using electrification to reduce emissions on the mainlines, and relying on less expensive emissions reduction methods for yard and local work, provide a useful framework during the transition toward rail decarbonization, particularly if electrification of mainlines can make cleaner equipment available for use on local routes.

4.1.2 Specifications

The study included utility companies from the beginning, including the municipally owned Los Angeles Department of Water and Power, which covered most of the study area. The study considered three electrification specifications:

- 25 kV
- 50 kV
- 25 kV with autotransformers (transmission at 50 kV, but 25 kV at the train)

The study found that, overall, 50 kV provided a marginal savings on electrical equipment, but created significant clearance issues due to the wider air gaps necessary to avoid arcing. The

option of autotransformers was rejected as too expensive and untested, so 25 kV was generally preferred. [Section 4.1.5](#) examines the clearance analysis in further detail.

4.1.3 Route Selection and Traffic Forecasts

The analysis covered 13 separate corridors, which consisted of commuter, freight, and mixed lines. The study found that electrifying the commuter lines only would be less expensive, but would not meet the emissions targets. The study evaluated two alternatives for freight electrification: electrifying a consolidated corridor onto which the freight railroads would be expected to shift traffic, or electrifying all the individual freight railroad mainline corridors.

The study elicited participation from all three Class I freight railroads operating in the basin at the time: UP, SP, and the then Atchison, Topeka, and Santa Fe Railway (ATSF). SP had the largest footprint in the basin at the time of the study. Four years after the study, SP merged with UP, and ATSF merged with the Burlington Northern Railroad shortly after the study, forming Burlington Northern Santa Fe Railway (BNSF).

The three freight railroads cooperating with SCRRRA on the study predicted 35 to 94 trains per day through the region by 2010. By way of comparison, the Alameda Corridor alone peaked at roughly 55 trains per day in 2006 and averaged 28 trains per day in 2022 (Alameda Corridor Transportation Authority, 2023).⁶

4.1.4 Providing Adequate Clearance

The report used a railcar height of 6.4 m (21 feet)⁷ and air gap recommendations from the then AREA manual to determine the clearance required for the three different types of electrification considered. The study created a comprehensive inventory of overhead obstructions throughout the corridors being analyzed in the basin, and determined which intervention, if any, would be necessary for 265 bridges in the region based on the following criteria:

1. Lower the track for obstructions less than 61 cm (2')
2. Raise the bridge for obstructions between 61 cm and 152 cm (2' – 5')
3. Replace the bridge for obstructions over 152 cm (5')

Some exceptions to these criteria were made for utilities, sidings, or other conditions that would prevent the preferred alternative and force the next most expensive option. [Table 9](#) summarizes the report's findings.

In addition to the bridges crossing over the rail corridors, the study identified six tunnels and seven through-truss bridges with potential clearance constraints. Utilizing absolute minimum clearances, the study concluded that, at 50 kV electrification, four of the tunnels would require substantial structural modifications, while at 25 kV, three of the tunnels could potentially reach adequate clearance by lowering the track.

⁶ Although the number of trains peaked in 2006, trains have grown significantly longer, and the total number of TEUs transported across the Alameda corridor has remained relatively steady since 2006.

⁷ This was slightly over two inches shorter than the height of AAR Plate H clearance, but the report does state that minimum clearances were based on compatibility with double-stacked intermodal railcars.

Table 9. Crossing Bridge Interventions in the SCRRA Study

Intervention	25 kV		
	Minimum Clearance	Desired Clearance	Railroad Requested Clearance
No action required	195	153	42
Lower the track	62	95	162
Raise the bridge	8	17	61
Replace the bridge	0	0	0
	50 kV		
No action required	52	40	38
Lower the track	185	151	131
Raise the bridge	28	74	92
Replace the bridge	0	0	4

There are two key takeaways from the SCRRA study’s clearance analysis, and the meetings SCRRA conducted with freight rail stakeholders. First, the relatively short distances and high density of overhead clearance restrictions in urban settings make switching to 25 kV electrification and increasing the density of substations economically superior across such locations, even though 50 kV might be preferred for longer rural stretches of the corridor to be electrified. Locomotives with the ability to switch between input voltages were considered impractical at the time of the study, but are more feasible now.

Secondly, freight railroads’ desire for additional clearance to avoid future restrictions points to a potential benefit of partial or intermittent electrification: in addition to directly lowering the amount of public works costs to provide additional clearance, intermittent electrification might bring additional buy-in from the freight railroads by reducing the risk of future clearance constraints.

4.1.5 Construction Costs

The project’s high capital costs, especially in comparison to the costs predicted in previous electrification studies, were likely the primary factor preventing the electrification acceleration project being built. This section examines why the project’s costs were so high. [Table 10](#) summarizes the project’s costs for the three scenarios that were calculated: 25 kV with minimum clearance, 25 kV with the railroads’ desired clearance, and 50 kV with minimum clearance.

Table 10. Summary of SCRRA Project Costs

All values in millions of 2024 dollars			
	25 kV Minimal Clearance	25 kV Desired Clearance	50 kV Minimal Clearance
OCS & Electrical Systems	1,832	1,728	1,832
Civil, Structural, & Signal Costs	1,261	1,354	1,354
Ancillary Costs	385		
Total Infrastructure Costs	3,478	3,467	3,571
Cost per route-km (per mile)	2.7 (4.3)	2.7 (4.3)	2.8 (4.4)
Cost per track-km (per mile)	1.5 (2.4)	1.5 (2.4)	1.5 (2.5)
Freight Locomotives	3,320		
Passenger Locomotives	907		

4.1.6 Capital Constraints

SCRRA estimated approximately 10 years for construction. There was a concern that the public funding sources would be capital limited to at most \$300 million per year (\$687 million per year in current dollars). Under such a capital limited scenario, construction would take roughly 18 years. Figure 12 shows the estimated yearly outlays under the two construction cases. The capital constrained case would be exposed to significantly more risk of cost overruns, as well as delaying project benefits considerably.

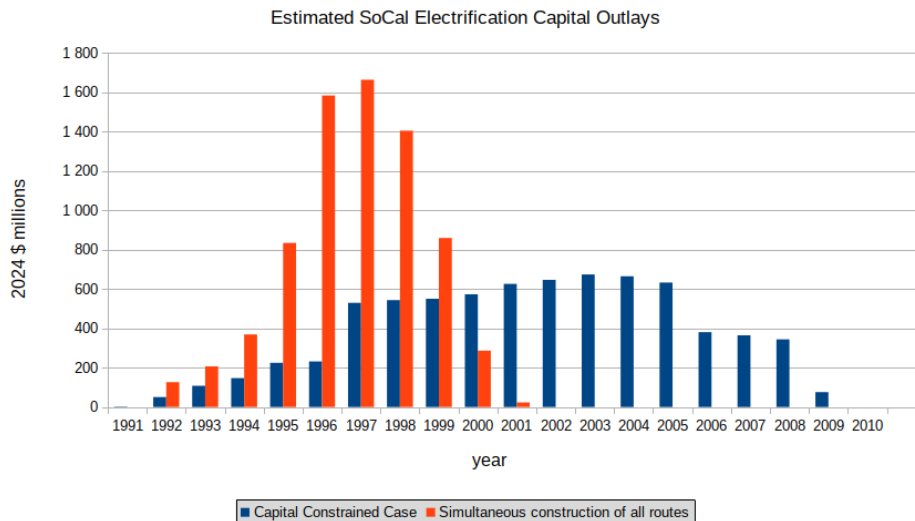

Figure 12. Proposed SCRRA Electrification Capital Outlays With and Without Capital Constraints

4.1.7 Excess Capital Costs Beyond Electrification

Among the 13 routes and 72 segments within the study, 558 grade crossings were identified and 43 of them were recommended for grade separation due to train traffic forecasts.⁸ Grade separation potentially represents a large cost that was included in the project despite not being directly related to electrification, and might explain why the per-km cost of this study was so high compared to the 1970s and 1980s studies. The 1970s and 1980s studies separated non-electrification improvements from capital budgets.

Additionally, the study determined that clearances at through-truss bridges should be replaced. The study report states, “Due to the age and condition of the existing portal signal bridges, it was deemed more cost effective to replace the existing portal signal bridges with new bridges constructed allowing adequate clearance for electrification” (Southern California Regional Rail Authority, 1992). This recommendation for replacement of the portal signal bridges could be related to the bridge needing substantial maintenance or replacement regardless of the proposed electrification project. Likewise with the grade separation recommendations, the full capital cost

⁸ These grade separations do not include the then-nascent Alameda Corridor project. The Accelerated Rail Electrification Project assumed the crossings along the Alameda Corridor would be grade separated outside the scope of the electrification, and provisioned for the grade separation of 43 additional grade separations along the UP/SP consolidated rail corridor.

of replacing the bridges seems to have been combined with the electrification costs. This stands in contrast to past electrification studies, such as SP’s studies, which carefully separated non-electrification capital costs.

Similarly, the report indicates that 558 crossing warning systems would have to be installed at a cost of \$128 million in current dollars. It is not clear why these crossing warning systems would require installation because of electrification. Perhaps this line item in the report refers to the modifications necessary at crossings using warning systems based on DC track circuits that are incompatible with AC electrification, but in that case the unit cost is more than enough to install an entirely new crossing warning system at each crossing.

4.1.8 Possible Over-engineering

The report states that several aspects of the substation design were based on maintaining the ability to eventually convert the system to 50 kV. This means that substation costs would have been based on both the inferior spacing of 25 kV substations and the more expensive insulation requirements of 50 kV substations.

4.1.9 Electric Locomotive Costs

The report quotes relatively high electric locomotive costs, as shown in [Table 11](#). The report states that costs were based on, “...the most advanced electrical locomotives used in the United States.” The study was conducted just before AC traction motors were widely adopted. Like other electrification studies from the previous decades, the study considered electric locomotives with much higher power ratings than the diesel locomotives they would replace. Unlike previous studies, higher speeds were not a design goal, meaning that especially in the case of the freight electric locomotive being considered, the design called for excess horsepower that would not be used by many freight trains.

Table 11. SCRRA Electric Locomotive Costs

	Power	1992 Dollars	2024 Dollars
Passenger Locomotives	4,320 kW (7,000 hp)	\$5,350,000	\$12,250,000
Freight Locomotives	6,210 kW (10,000 hp)	\$4,141,000	\$9,483,000

The cost of an electric freight locomotive included \$200,000 (about \$458 000 in current money) for a secondary cab, “...to improve operational flexibility” (Southern California Regional Rail Authority, 1992). The report mentioned that the large number of locomotives necessary for the project might reduce costs due to economies of scale, but also cautioned that the large number of rail stakeholders involved might require slight differences in their locomotives, possibly eliminating any economies of scale. The report did not assume any cost reductions for the locomotive acquisition. Analysis of predicted train movements in the basin led to the conclusion that between 228 and 271 freight locomotives would be necessary by the year 2000.

The task force concluded that each electric locomotive would cost more to maintain than a diesel-electric locomotive per unit distance traveled. This contrasts with previous electrification studies, which concluded that the lack of a prime mover would substantially reduce maintenance. The SCRRA report based its electric locomotive maintenance on information from BC Rail’s Tumbler Ridge electric operations, dated from 1985. While the report notes in various places that

locomotive maintenance can be higher in mountainous operations, the mountainous BC Rail electric locomotive maintenance rate is used directly, while the diesel rate is averaged from several American sources across broad networks with a wide range in topography. In fact, the task force also obtained locomotive maintenance rates for BC Rail's diesel fleet, which was indeed higher than the average rate. Additionally, the report used a dubious methodology to convert BC Rail's rates in 1985 Canadian Dollars per km to 1992 US Dollars per mile, which may have exacerbated the discrepancy.⁹

The locomotive maintenance costs were adjusted based on horsepower to account for the smaller number of electric locomotives that might be used overall, compared with the equivalent number of diesel locomotives. The reduction in locomotives was based on a ratio of three electric locomotives per two diesel locomotives. The conclusion that electric locomotives are more expensive to maintain was consistent with Amtrak's Northeast Corridor (NEC) experience at the time, although the report notes that the higher maintenance costs on the NEC might be related to the higher speeds and mileage imposed on Amtrak's electric fleet compared to its diesel fleet.

4.1.10 Power Costs

The report raises the interesting question of how power costs would be shared among the freight and passenger operators, since the substations cannot determine which train is using the power being put onto the catenary. The report mentions that Conrail installed meters on its locomotives operating along the Northeast Corridor to settle payment disputes with Amtrak. The report also notes that the cost of installing and monitoring such meters might be reduced by using a sampling plan, although details are not discussed.

4.2 California Air Resources Board Study (2016)

The California Air Resources Board (CARB) commissioned a study to examine the economics and operating characteristics of different options to decarbonize line-haul freight rail operations in California (Rail Transportation and Engineering Center, 2016).

This study followed-on from prior work on rail electrification in the South Coast Air Basin (SCAB), and examined several different locomotive technologies:

- Tier 4 conventional diesel-electric locomotives with after-treatment
- Dual fuel natural gas locomotives using liquefied natural gas fuel tenders
- Diesel-electric locomotives with battery tenders and onboard battery storage
- Solid-oxide fuel cell (SOFC)
- Conventional electrification via OCS
- Linear synchronous motors (LSM)

⁹ The report provided a clear methodology in Section 6.5.1.2 of Volume 2, which notes that they adjusted for inflation before adjusting for the exchange rate. Because the US and Canada had slightly different rates of inflation over the period in question, the methodology outlined in the report does not maintain purchasing power. This difference in methodology increases the effective maintenance rate by approximately 10 percent (9.7 percent). An equivalent error likely exists in the report's conversion of BC Rail's catenary maintenance information, although the methodology for those calculations is not explicitly stated.

The wide range of alternative locomotive technologies considered in this study reflects the way locomotive technology has advanced, whereas nearly all rail electrification studies from the 1960s through 1990s solely examined electrification via OCS.

Like the SCRRA study from 25 years prior, this study primarily focused on the SCAB with an emissions reduction motivation, and assessed locomotive change points at the SCAB boundaries. Unlike the prior study, this one also examined a North American deployment scenario, assessing two technologies on a theoretical continent-wide deployment to better determine how the locomotive change points affected the economic performance.

In 2012, before the CARB study, the Southern California Association of Governments conducted its own study of electrification in the Los Angeles basin for its 2008 Regional Transportation Plan, and issued a report (Cambridge Systematics, 2012).

The aspect that makes the CARB study of particular interest is that it was one of the first major studies to examine full battery electrification of freight rail in the North American context. The study's battery tender analysis looked at several battery electrification options, including

- Trains would travel to the boundaries of the SCAB under battery power, and at that point change locomotives and drop-off the discharged battery tenders
- Trains would travel to the boundaries of the SCAB under battery power and continue without stopping under diesel power, hauling the discharged battery

Between the battery performance of the era, the time and capital cost associated with locomotive exchange points, and the inefficiency of hauling uncharged batteries, the study found that none of the battery tender modes analyzed would be economically feasible. This work set the stage for additional battery electrification studies as the technology progressed.

Additionally, the study provided quantification of the network effects surrounding electrification, showing the downsides of a single agency attempting to reduce emissions in a vacuum.

4.2.1 Focus on Climate Change

The prior SCRRA study was motivated by the desire to reduce emissions contributing to smog and other negative health effects, and did not reference CO₂ emissions. While health degrading pollutants were still a significant part of the CARB study, by 2016 CO₂ was an important part of the analysis.

4.2.2 Locomotive Change Point Analysis

Because the study was primarily looking at the limited scope of an electrified network within the SCAB boundaries, it accounted for the infrastructure and time required to change locomotives at the edges of the electrified territory. The methodology employed could be useful for any limited-scope electrification, as well as for analyses of electric operations during the initial years of a project before a full electrified network can be built out. [Table 12](#) shows the train delay cost factors the study used, converted to current dollars. These factors incorporate direct costs (e.g., crew wages and fuel) from idling, as well as less direct costs (e.g., the opportunity cost of a locomotive or railcar waiting at the change point rather than earning revenue on the rail network).

Table 12. Train Delay Cost Factors

Cost Category	Rate (2024 \$)
Crew (per train-hour)	103.4
Locomotive Diesel Fuel (per locomotive-hour)	240.50
Locomotive Operating (per locomotive-hour)	86.75
Bulk railcars (per railcar-hour)	0.75
Manifest railcars (per railcar-hour)	1.09
Intermodal railcars (per railcar-hour)	1.30

The study conducted field experiments and found that, “Depending on the locomotive configuration, locomotive exchanges are likely to take between 60 and 222 minutes at the locomotive exchange points.”

The analysis found that delays at the locomotive exchange points could cause 11.3 million tonnes (12.5 million tons) of freight to shift from rail to truck annually, potentially costing railroads \$1.4 billion (current dollars) yearly in revenue, and eliminating a significant portion of any of the emissions benefits from any of the technologies reliant on the exchange points. Compared to Tier 4 locomotives operating across the rail network (and thus obviating the need for locomotive exchange points), many of the technologies reliant on the exchange points would cause a net increase in emissions. Electrification by battery or by conventional OCS still showed emissions reductions for CO₂ and CO compared to the Tier 4 baseline. The mode shift calculations outweighed most other considerations in the study’s cost benefit analysis.

4.2.3 Battery Analysis

For freight propulsion with battery power, the biggest challenge at the time of the study was the low energy density of the batteries in question. Dozens of battery tenders would be required to power a full freight train from the ports to the boundary of the SCAB.

The study highlighted the ability of battery tenders to potentially capture dynamic braking energy for reuse in charging the batteries, thus providing energy savings. For AC-traction locomotives (21 percent of the line-haul fleet at the time the study was written), the study concluded that the procedure to connect and utilize battery tenders would be straightforward, and require few modifications to the locomotives. For DC traction locomotives, interfacing with battery tenders would require complex and potentially expensive electrical hardware which would itself reduce the amount of space available for the batteries.

The study found that, for a typical freight train carrying 6,800 tonnes (7,500 tons) of revenue freight, a 6.2 MWh battery tender design (with 5 MWh of usable charge) could propel the train roughly 34 km (21 miles) on one charge and mitigate 338 gallons of diesel fuel consumption (1,280 liters) in the process.

Each of the five MWh battery tenders were estimated to cost \$6.5 million (current dollars) at the time of the study, but researchers expected that cost to fall if battery technology advanced and as battery prices improved. Additionally, as battery capacity improves, fewer battery tenders will be necessary for the same train movements.

The study found that, once the batteries become depleted, their extra weight would reduce fuel efficiency to the point that a train unable to utilize regenerative braking (for example, on a relatively flat route) might consume more diesel overall. This means that, without a reliable

means to re-charge the batteries, railroads would likely stop trains to remove the battery tenders at the locomotive exchange points before continuing beyond the SCAB, imposing the same delays discussed previously.

The next case study in this report examines two studies from the UK that aim to bridge the technical gap batteries presented by examining the possibility of recharging the batteries en route.

4.3 Intermittent Electrification Studies from the United Kingdom

Intermittent electrification refers to the concept of deploying discontinuous segments of OCS along a rail corridor with trains using electric traction under the OCS and some other means of traction to bridge the gaps. Intermittent electrification has not been implemented across very large gaps in OCS, although it is common for electric trains to coast through short gaps in electrification as part of normal operations.¹⁰ As battery technology has improved, longer gaps might be possible that still use electric traction.

The first study, from 2012, examined the Great Western Main Line (GWML), which travels roughly 190 km (118 miles) westward from London to Bristol before eventually reaching Cardiff through the 7,012 m (4.4 mile) Severn Tunnel (Hoffrichter, Silmon, Schmid, Hillmansen, & Roberts, 2012).

The second study, which is the most recent case study discussed in this report, examined intermittent electrification as one alternative between Newcraighall North Junction and Tweedbank in Scotland, a distance of 52 km (32 miles) (Beechey & McKlerie, Lindsey, Discontinuous Electrification Study: Scottish Borders Railway Newcraighall North Junction to Tweedbank, 2021).

4.3.1 Great Western Mainline

The GWML is among the UK's remaining non-electrified mainlines. While the UK government announced plans to electrify the GWML, several long tunnels along the route, including one over 7 km (4.4 miles) long, served as impediments to full electrification. Hoffrichter (2012) examined the potential for intermittent electrification along the route, and simulated different types of passenger trains under the following conditions:

- Diesel-electric operations
- Fully electric operations with OCS
- Electric trains coasting through OCS gaps in discontinuous electrification
- Dual-mode trains operating through discontinuous electrification

[Table 13](#) shows the travel times and energy consumption for several eight-car trains (Hoffrichter, Silmon, Schmid, Hillmansen, & Roberts, 2012). The diesel-electric train consists of two Class 43 locomotives and eight coaches, while the other trains in [Table 13](#) are 8-car Intercity Express

¹⁰ Trains in the Netherlands routinely coast through 75 m (246 ft) gaps in electrification across some bridges that cannot be electrified due to shipping. Shorter gaps are far more common.

Programme (IEP) trains. The net energy consumption in [Table 13](#) includes the energy used to produce electricity based on the characteristics of the UK electricity grid at the time of the study. The electric IEP coasts through OCS gaps, including the long gap through the Severn Tunnel. The dual mode IEP uses electricity from the OCS where available and switches to onboard diesel generators through gaps.

Table 13. Simulated 8-car Passenger Trains Across the GWML

Train	Round Trip Journey Time (min)	Train Energy Consumption (kWh)	Train Net Energy Consumption (kWh)	CO2 Emissions (kg)	Lowest Speed in Severn Tunnel (km/hr)
Diesel-electric Train for Comparison	225	17,124	19,911	5,240	N/A
Fully Electrified	209	6,000	17,647	3,660	N/A
Discontinuous Electrification with Electric Train	214	5,868	17,259	3,579	14
Discontinuous Electrification with Dual-mode Train	210	6,151	18,202	3,912	95

The simulations showed that avoiding expensive OCS construction through the route’s tunnels would still allow a fully electric 8-car train to traverse the route, albeit slightly slower. Researchers concluded that the low speed through the tunnel might lead to unreliability in actual operations. For example, if the train is forced to enter the tunnel at a lower speed than preferred, it might stall. The dual-mode IEP’s ability to supply power throughout the journey improves the reliability while maintaining most of the energy savings, as shown in [Table 14](#). This result illustrates the potential for discontinuous electrification with powered propulsion across the OCS gaps.

Table 14. Simulated Intermittent Electrification Passenger Train Performance Versus Diesel-Electric Operations Across the GWML

Train	Reduction in Travel Time	Reduction in Net Energy Consumption	Reduction in CO ₂ Emissions
Fully Electrified IEP	7%	11%	30%
Discontinuous Electrification with electric IEP	5%	13%	32%
Discontinuous Electrification with dual-mode IEP-D	7%	9%	25%

The exact findings of the analysis is not applicable to freight rail operations, but the study showed that intermittent electrification can potentially be used to avoid the largest costs of OCS while maintaining most of the benefits.

4.3.2 Scottish Borders Railways

Beechey (2021) sought to, “Determine whether there is a viable alternative traction power option which is cost effective, reliable, and offers comparable performance and capacity provided by

the existing diesel-powered fleet operated by ScotRail.” The study examined the route from Newcraighall North Junction (just south of Edinburgh) to Tweedbank, separating the analysis at Newcraighall South Junction. Past the north junction, the line was already electrified. As part of a broader goal to decarbonize the rail network by 2050, this study examined the feasibility of extending the electrification southwards and other options, including:

- Battery Electric Multi Unit (BEMU)
- Hydrogen EMU
- Discontinuous Electrification with BEMU Hybrid

According to the study, route clearance was “one of the greatest contributing factors to increased electrification costs...” within the UK’s nationwide electrification project. The report notes that, depending on voltage, UK electrifications require an air gap of 270 mm to 600 mm (10.6” to 23.6”). This gap can be reduced with treatments such as surge arresters or insulated coatings.

The route being analyzed included multiple bridges and tunnels with low clearance. Additionally, some of the route’s viaducts and stations are not configured in a way that is conducive to conventional OCS pylons.

The study proposed that, in the discontinuous electrification case, OCS would tie-in with the existing electrification on the north end of the route and continue for a bit more than 11 km (7 miles), where a trackside transponder would signal the train to dynamically drop its pantograph. At that point, the OCS would be discontinued for about 8 km (5 miles), avoiding several sections that would be costly to electrify. Along that section, an interconnector parallel to the track (but outside of the problematic clearance envelopes) would transmit the power to the next section of electrification so that a separate substation would not be necessary for the subsequent 21 km (13 miles) of OCS. Another trackside transponder at the start of that OCS ‘island’ would signal the train to raise its pantograph again.

The study concluded that these segments of OCS would put the rest of the route ‘comfortably’ within the BEMU’s range.

4.3.3 Capital Savings from Discontinuous Electrification

Table 15 shows the capital expense (CAPEX) estimates for fully electrifying the route and for providing discontinuous electrification. The discontinuous electrification case, by avoiding 14 bridges, 4 tunnels, and any new transmission lines or substations, saves over \$181 million (current US dollars) in capital expenses versus the full electrification case. This analysis does not consider the added cost of BEMUs or charging facilities, but a 66 percent reduction in cost for provisioning the other electrification infrastructure shows the large potential discontinuous electrification might have.

In this study, 55 percent of the route and 56 percent of the track length is electrified. In addition to the savings on public works, most of the segments electrified under the discontinuous electrification case are long, simple sections of the route, which had lower unit costs in the study. Table 16 shows the OCS costs per unit distance. One way to interpret this table is that the discontinuous electrification case sites OCS along segments that are roughly 7 percent less expensive to construct than the average OCS cost across the full route.

Table 15. Scottish Borders Railways Full and Discontinuous Electrification CAPEX

All monetary values in millions of 2024 US Dollars								
	Length Electrified km (mi)	Track Length Electrified km (mi)	OCS	Trans-Mission	High-Voltage Inter-connect	Bridge Clearances	Tunnel Clearances	Total CAPEX
Full Elect.	52.2 (32.4)	68.5 (42.5)	\$124	\$30	\$0	\$66 (22 bridges)	\$54 (4 tunnels)	\$274
Disc. Elect.	28.9 (17.9)	38.4 (23.9)	\$64.4	\$0	\$4.5	\$24 (8 bridges)	\$0	\$93

Table 16. Scottish Borders Railway OCS construction Costs Per Route Distance and Track Distance

All monetary values in 2024 US Dollars		
	OCS cost per route length \$/km (\$/mi)	OCS cost per track length \$/km (\$/mi)
Full Electrification	\$2.39 (\$3.84)	\$1.82 (\$2.93)
Discontinuous Electrification	\$2.23 (\$3.59)	\$1.68 (\$2.70)
Discontinuous Cost Reduction	7%	8%

This was a preliminary analysis. For example, the report used a fixed cost per bridge intervention of a half million pounds (\$750,000 in current US dollars) and the report did not analyze whether the substation that the discontinuous electrification would tie into has the excess capacity required.

4.4 Modern Commuter Rail Electrification Studies

Although the scope of this study is focused on mainline freight rail electrification, to the extent that they can inform the economic evaluation and risk analysis of modern options for railway electrification, the project team also reviewed studies related to the electrification of two different commuter rail systems: Caltrain commuter service between San Francisco and San Jose/Gilroy, CA, and Metrolinx GO Transit commuter service radiating from Toronto, Ontario, Canada.

4.4.1 Caltrain Modernization Program (1992-2024)

In 2024, Caltrain inaugurated electrified commuter rail service on 82 route-km (51 route-miles) of 25 kV 60 Hz AC electrification extending from San Francisco to San Jose, CA. The electrification project was one component of the larger \$2.44 billion Caltrain Modernization Program that also included replacing the existing diesel-electric locomotive-hauled commuter railcars with European-style bi-level electric multiple-unit railcars (EMUs) and installation of a new PTC system.

4.4.2 1992 Study

A feasibility study for electrifying the Caltrain commuter service was first conducted in 1992. The motivation for the study was the potential for faster train service, reduced operating costs through fuel, crew and maintenance savings, and reductions in noise and air pollution (Morrison Knudsen Corporation, 1992). Train performance simulations showed that electric locomotives and EMUs both offered travel time savings over the diesel-powered trains in service at the time. However, compared to the EMUs that would replace all existing rolling stock, use of electric locomotives would allow for continued use of the relatively new commuter coaches in service at the time.

The 1992 study examined 25 kV DC, 1.5 kV DC and 600-volt DC OCS along with 600-volt third rail power supply systems. The 25 kV system required substations every 20 miles while the 600-volt options required substations every mile. Because the 25 kV system minimized the number of substations and utility connections, required the smallest OCS conductor size, and could use standard equipment, it was recommended for implementation at a catenary construction cost of \$400,000 per track-mile (\$566,000 per track-km or \$911,000 per track-mile in modern dollars; this value excluded civil construction costs for increasing tunnel and bridge clearances). The study noted that the 25 kV system required replacement of the signal system, but that the existing signaling system was due for renewal and the corresponding cost should not be charged against the electrification.

In making its economic evaluation, the study considered that increased ridership revenue from improved service under electrified operations would partially offset annual operating and capital costs. However, the study concluded that annual costs under electrification would increase relative to diesel operations and require additional subsidies to support the economic “shortfall” arising from the electrification investment.

4.4.3 1998 Study

Caltrain electrification was revisited in the 1998 Caltrain Rapid Rail Study as one component of a comprehensive approach for improving and expanding the commuter railroad physical infrastructure. This approach aimed to improve travel times and increase ridership while also being a better neighbor to surrounding communities (Caltrain & STV Incorporated, 1998). The study noted that electrification offered benefits in both areas by reducing travel times and creating less noise and air pollution. Specifically, the project identified \$543 million in track and other infrastructure rehabilitation and enhancement projects that, when combined with a \$376 million investment in electrification from San Francisco to Gilroy, would reduce travel times by 21 percent with a corresponding increase in ridership (\$1.06 billion and \$732 million today, respectively).

In evaluating the costs of electrification, the 1998 study references the ongoing (at the time) Amtrak NEC Electrification Project to install 257 route-km (160 route-miles) of double-track OCS and 25 substations between New Haven and Boston, while also modifying clearances of 7 overhead bridges in a 3-year period. The cost of the NEC project was \$1.2 billion (or \$3.8 million per track-mile in 1998 dollars, equivalent to \$4.6 million per track-km or \$7.4 million per track-mile in current dollars), including all infrastructure improvements to bridges, elimination of grade crossings, trackwork, substations, OCS, and signals and communication.

The electrification cost estimate was divided into two segments: 50 miles of double track between San Francisco and Tamien, and 27 miles of single track from Tamien to Gilroy. On both segments, the unit prices for OCS were estimated as \$492,000 per track-mile (\$595,000 per track-km or \$958,000 per track-mile in current dollars) with an additional \$2.3 million per substation (\$4.5 million today) and \$1.8 million for connection to the local electrical utility (\$3.5 million today). The total infrastructure and incremental signal costs (over already planned improvements independent of the electrification) was \$123.6 million (\$240.8 million today) on the longer double-track segment to Tamien, and \$30.7 million (\$59.8 million today) on the shorter single-track segment extension to Gilroy. Not included in these values was the cost of new electric locomotives estimated at \$5 million each (\$9.7 million today). Factoring in the cost of locomotives, a 40 percent contingency, and additional costs for Amtrak support, design, construction management, and supervision, the total cost was estimated at \$323.8 million (\$630.8 million today) for San Francisco – Tamien and \$51.2 million for Tamien – Gilroy (\$99.7 million today).

The 1998 Rapid Rail study recommended that the Caltrain electrification be implemented using a design/build/procure approach to streamline development and better align the design of the infrastructure improvements with the electrification infrastructure and rolling stock. Such an approach was suggested to be particularly beneficial if bi-level EMU technology were implemented, at an estimated cost of \$4 million per vehicle (\$7.8 million today) or \$372 million (\$725 million today) for the Tamien segment (EMUs were not found to be viable on the Gilroy segment) in place of \$115 million (\$224 million today) for new electric locomotives and continued use of the existing passenger railcars.

The 1998 Caltrain Rapid Rail Study did not detail possible funding arrangements or sources for the electrification program and the project languished.

4.4.4 Final Implementation

In 2012, the Caltrain electrification project was revived in a proposal to blend Caltrain operations on a modernized corridor with those of the California High-Speed Rail Authority (CAHSR) to form the northern end of a developing high-speed rail network linking San Francisco to Southern California (LTK Engineering Services, 2012). The blended operation would allow Caltrain and the CAHSR to combine local and new federal high-speed rail program resources to advance modernization and electrification of the Caltrain corridor between San Francisco and San Jose. Electrification of the extension to Gilroy was not included in the program and would be served by diesel-electric shuttle trains connecting to the electrified portion of the blended Caltrain and CAHSR operation at Tamien. The project retained the 25 kV 60 Hz AC electrification design to be compatible with the now connecting CAHSR system and the Amtrak NEC.

In a departure from the earlier studies, the blended approach to electrification would require new European-style EMUs for the Caltrain service and an entirely new advanced communications-based overlay signal system (CBOSS) custom-designed for the project to meet PTC requirements while maintaining interoperability and improving operational efficiency for speeds up to 110 mph. Due to implementation challenges, the custom-developed CBOSS would later be dropped in favor of the standard Wabtec I-ETMS PTC system adopted by Class 1 freight railroads, resulting in substantial increases in the cost of the project unrelated to the actual electrification itself.

Operational analysis indicated that peak electrical demand from this blended system would be approximately 75 MW with typical loads in the range of 40 to 50 MW.

Prior to the start of construction, a 2016 funding plan estimated the overall cost of electrification infrastructure at \$1.3 billion for 50 route-miles of double-track mainline plus additional passing yard and terminal tracks fitted with OCS (Project Finance Advisory Ltd., 2016). An additional \$664 million was budgeted for the EMUs (\$882 million today) and \$231 million (\$307 million today) for the CBOSS PTC system. The specific breakdown of the electrification infrastructure cost indicates that the materials and installation only represent an expense of \$696.6 million (\$925.6 million today; Table 17), or just \$5 million per track-mile (\$4.1 million per track-km or \$6.6 million per track-mile today). The substantial contingency and management costs nearly double this amount.

Table 17. Estimated Caltrain Electrification Infrastructure Costs (Excluding EMUs)

Cost Category	2016 \$ (million)	2024 \$ (million)
Electrification	696.6	925.6
Tunnel Notching	11.0	14.6
Real Estate	28.5	37.9
Private Utilities	63.5	84.4
Management Oversight	141.5	188.0
TASI Support	55.2	73.4
RRP Insurance	3.5	4.7
Environmental Mitigations	17.7	23.5
Required Projects	17.3	23.0
Maintenance Training	1.0	1.3
Finance Charges	3.2	4.3
Contingency	277.0	368.1
Total	1,316.1	17,48.7

Construction of the Caltrain electrification began in 2017, and OCS support foundation construction was completed by mid-2022 with portions of the OCS energized later that year. Initial testing of the OCS and electrified trains began in June 2023. Electrification was completed in April 2024 with the first EMUs entering service in August 2024 and full conversion to electric operations in late September 2024.

4.4.5 GO Transit Electrification Study (2010)

Metrolinx operates an extensive system of bus and commuter rail lines in the Greater Toronto and Hamilton Area of Ontario, Canada. Operated as “GO Transit,” the commuter rail network includes seven corridors that use diesel-electric locomotives hauling bi-level coaches and cab cars in a push-pull configuration. In 2010, Metrolinx initiated a study of future electrification of the entire GO Transit rail network (Arup, 2010). The scope of the study included a comprehensive assessment of rolling stock technology, consideration of power supply and distribution options, and an evaluation of implementation options for electrifying all or selected portions of the GO Transit rail network.

The combined analysis of rolling stock and power supply/distribution technologies included:

- Diesel-electric locomotives and Diesel Multiple Units
- Electric locomotives and Electric Multiple Units powered by
 - OCS
 - Third rail
- Dual-mode locomotives with an on-board diesel and capability to use electric propulsion in electrified territory
- Alternative locomotive fuels
- Hydrogen fuel cell trains
- Battery-powered trains
- Maglev

Of these options, based on technical, commercial, and compatibility criteria, the first four were selected for further consideration, with the conclusion that electric locomotives were the preferred option to compare to the existing diesel-electric base case. It was also determined that OCS electrification operating at 25 kV 60 Hz AC was the most appropriate power supply option, and was used to develop conceptual designs and cost estimates.

The study examined 18 network options ranging from electrifying one line to electrifying all corridors to some extent. The study found that electrifying the westernmost segment of the Lakeshore line was cost prohibitive with OCS and electric locomotives due to the high cost of tunnel and bridge modifications relative to the limited train service to St. Catharines. The 18 network options were compared to the diesel base case across various evaluation categories that included greenhouse gas emissions, regional and local air quality, journey times and reliability, social impacts on residents and communities, economic cost-effectiveness, capital and operating costs, revenues, and deliverability.

Electrifying the entire network would reduce GO Transit greenhouse gas emissions by 94 percent, but this only represented 0.32 percent of the overall emissions in the region. Because GO Transit already committed to operations with EPA Tier 4-compliant diesel-electric locomotives, electrification only offered modest improvements in other pollutants and local air quality.

The economic analysis of the alternative electrified networks considered both a power demand charge and energy consumption charge, resulting in an average annual cost of electricity of 10.8 cents/kWh across the entire network (15.7 cents/kWh today). The cost of energy from diesel fuel was found to be greater than that derived from an electrical system. While the cost of diesel fuel was expected to increase at a greater rate than electricity, the study acknowledged that there were significant uncertainties in the cost of electricity and diesel in the future.

Capital cost estimates ranged from \$900 million for electrification of the 115-km (71-mile) Georgetown line (\$1.3 billion today) to over \$4 billion (\$5.8 billion today) for the entire 509 km (316 miles) network. These estimates included contingencies of 35 to 55 percent to account for uncertainty and risk.

The benefit-cost ratio (BCR) calculated by the study for each alternative was found to be sensitive to several assumptions. A detailed sensitivity analysis (Figure 13) indicated that the BCR was most sensitive to infrastructure capital costs, incremental maintenance cost savings, and energy cost inflation assumptions. Given these sensitivities, a range of possible BCRs was calculated for each network alternative, corresponding to a central case, upside, and downside scenario. Only one alternative produced a BCR that was likely to exceed 1:1, while two options had a fair chance of delivering a BCR higher than 1:1. Two options did not yield a BCR greater than one (i.e., costs outweighed benefits) under the applied evaluation framework. The study suggested that justification for these latter options would need to be supported by other non-monetized benefits.

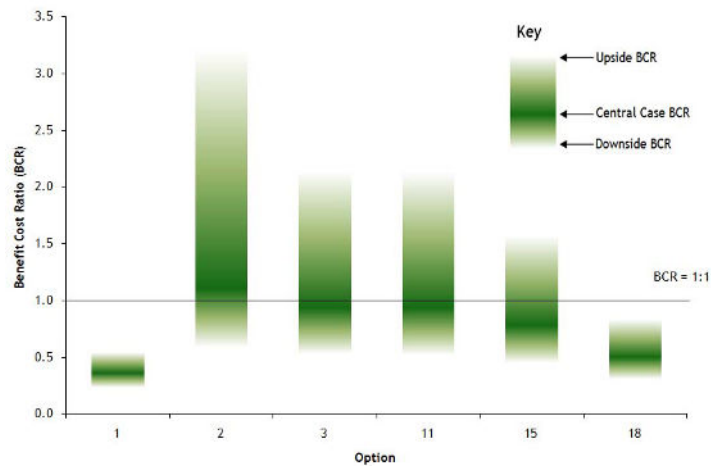

Figure 13. Sensitivity Analysis Range of BCRs for GO Transit Electrification Scenarios

Although focused on commuter rail operations, the sensitivity analysis and presentation of a range of possible BCR outcomes in the GO Transit study provides a model for a risk-based evaluation framework of modern options for freight rail electrification.

5. Key Barriers to Freight Rail Electrification

Based on the material presented in the previous sections, the project team analyzed the studied literature to identify, categorize, and prioritize the most common and important technical and economic barriers to electrification that require innovative solutions. Key barriers are summarized in the following sections, starting with the higher-level economic barriers, then moving to specific technical challenges, and then finally introducing the broader institutional obstacles facing mainline railway electrification in the North American freight operating context.

5.1 Economic Barriers

As detailed in several of the case studies from the 1970s and 1980s, electrification offered numerous railroads a high positive ROI based on the information available and internal assumptions made by the railroads. However, in nearly all cases, the rate of return was less attractive than other uses of capital once risk was factored-in, and the railroad simply could not raise sufficient up-front capital to realize returns from electrification, or other pressing capital projects such as infrastructure renewal and expansion, along with rolling stock and signal renewal, took precedence. This outcome suggests five separate economic barriers combined to produce an unattractive rate of return or capital commitment for railway electrification: 1) costs are high; 2) benefits are small; 3) scope of benefits is narrow; 4) benefits are not accrued early during the project; and 5) uncertainty and risk make it likely that one of the other barriers will occur.

5.1.1 High Costs

A railroad project's rate of return can be improved by reducing the capital costs for which the railroad will be responsible. While creative project structures such as cost-sharing partnerships with utilities would likely reduce the initial capital investment required by the railroad, the structure of the agreement might leave the railroad responsible for eventually paying the full cost of electrification through the electricity rates charged by the utilities. Reducing the capital costs to the utilities could, in theory, result in lower electricity costs delivered to the railroads at the wire. However, few technical options to decrease the total cost of traditional OCS electrification are explored in the literature. One exception is the development of more economically designed OCS support structures with lower clearance profiles to fit inside tunnels and under overhead highway bridges, or changing to lower voltage (from 50 kV to 25 kV, or 25 kV to 12.5 kV) to reduce required clearance through these structures.

In general, past studies assume that all main tracks and passing sidings within a certain corridor or network will be electrified through a single project. Little consideration is given to investigating if all track segments need to be electrified during the initial construction, or if certain sidings and main tracks in high-cost areas can be left for later project phases. Thus, later sections of this report attempt to quantify how battery, hybrid, and DML technology may facilitate cost-saving gaps in the traditional approach to electrification. It also discusses whether railroads can feasibly electrify partial routes without the complexity and costs of locomotive exchanges documented in the 2016 CARB study that included partial electrification of mainline routes in Southern California.

5.1.2 Low Benefits

The rate of return of a project can also be improved by increasing its ongoing benefits to the railroad. As discussed earlier, virtually all the legacy railroad electrification studies center on the critical benefit of reduced locomotive traction energy costs when electricity is compared to diesel fuel. The reduced maintenance costs of electric locomotives, relative to diesel-electrics, are normally given a secondary consideration when calculating benefits. As documented in more modern studies conducted by public agencies, elimination of diesel propulsion in favor of electrification offers many societal benefits related to decarbonization and the public health impacts of particulate matter contained in diesel exhaust. It is difficult for private railroads to quantify these external benefits and then internalize them to a potential railroad project without some sort of public-private partnership or other Federal/State/Local funding mechanism or economic incentive. Such partnerships involving freight railroads were once relatively rare but have become commonplace over the last 15 years through various federal programs designed to finance development of critical freight transportation infrastructure, such as FRA's Consolidated Rail Infrastructure and Safety Improvements (CRISI) grant program. Note that the successfully implemented freight railway electrification in British Columbia was partially funded by environmental grants from public agencies. Later sections of this report explore the extent to which monetizing these public benefits and indirectly or directly sharing costs can increase the benefits and overall rate of return for the railroad share of the required capital investment.

5.1.3 Narrow Scope of Benefits

In calculating the rate of return of railway electrification, the scope of benefits is typically kept rather narrow with a focus on items that directly relate to energy, maintenance, and infrastructure costs. Little consideration is given to potentially raising the level of benefits through alternative revenue streams such as leasing railroad ROW for co-location of electrical transmission lines. With more widespread electrification of all transportation modes, the overall demands on the electrical transmission grid are increasing, and there is a particular need to efficiently connect remote sources of renewable wind and solar generation with large population centers of high electrical demand. As pressure to build new transmission grid links intensifies, ROW suitable for construction of high-voltage lines will become more valuable to utilities. With their long, linear corridors, railroads are ideally positioned to benefit from this demand for ROW by co-locating new transmission along their lines. This additional revenue stream falls outside the scope of benefits traditionally included in railway electrification studies. Although explored later in this report to some extent, further research is needed to determine the potential for co-location and the value of this option to electrical utilities and grid operators. Such a co-location might involve a direct transferal from the utility companies to the railroads as a lease agreement, or might otherwise take the form of reduced (or guaranteed long term) energy rates that may help mitigate the risk and uncertainty of long-term energy cost benefits.

5.1.4 No Initial Benefits

The rate of return of a project and its overall impact on cashflow can be improved when positive benefits begin to accrue during the earliest years of the project. Unfortunately, the traditional approach to electrification requires that all infrastructure be installed and locomotives delivered before electrified operations begin and savings (i.e., benefits) are realized after multiple years of infrastructure planning and construction and locomotive development and delivery. The studies

reviewed during this phase of the project do little to investigate how the construction timeline might be accelerated, or how alternative operating schemes might allow some trains to operate using the OCS and accrue positive benefits earlier in the project before full-scale implementation is complete. Subsequent sections of this report investigate techniques to accelerate construction of the OCS and ways to leverage partial and/or progressive electrification schemes to start yielding benefits earlier during the project timeline. These partial and progressive electrification schemes are further discussed in [Section 5.2](#).

5.1.5 Uncertainty and Risk

Even a detailed rate of return calculation for railway electrification is only valid for the specific set of assumptions and forecasts underlying the parameters and rates involved in the analysis. Many of the studies found in the literature implied large rates of return when forecasts of long-term traffic, electricity rates, and diesel fuel prices are all favorable. However, that rate of return can quickly collapse if even one of these factors deviates from a favorable forecast. Due to the calculation limitations at the time, many of the older railway electrification studies lack even a sensitivity analysis to explore low, medium, and high scenarios for various traffic and energy cost forecasts. More modern studies typically explore more alternative scenarios, but clearly communicating the exact overall rate of return “risk profile” of a large investment in railroad electrification created by uncertainty in inputs remains a challenge. Later sections of this report will demonstrate more recent approaches that use Monte Carlo simulation to investigate all possible combinations of input parameters in a probabilistic manner to produce a probability distribution of different rates of return for an electrification project. These distributions can be an effective tool in communicating the financial risk of a project and determining if it aligns with the business objectives of the project owner or those financing the project.

Once these approaches better quantify the risk and uncertainty involved in electrification, schemes aimed at reducing the risk railroads face can be re-evaluated. For example, several past studies proposed innovative partnerships that would have seen the risk shared between the railroads, the utility providers, and public agencies. Railroads in most past studies sought some form of guaranteed electricity rates to provide inoculation from energy price fluctuations over the lifespan of the project. Capabilities now exist to estimate the exact effects of specific rate structures.

5.2 Technical Challenges

The economic barriers detailed in the previous section suggest that addressing certain technical challenges are critical to the feasibility of modern railway electrification approaches. The primary technical challenge centers on the development of technology to feasibly support partial and progressive electrification. Two related, but secondary, technical challenges involve the continued conflict between AC electrification and DC track circuits, and uncertainty in the exact clearance requirements for the 50 kV electrification that will likely be required to support North American freight operations.¹¹

¹¹ As early as 1992 in the SCRRA study of the Los Angeles basin, there was an understanding of the air gap requirements imposed by 25 kV and 50 kV electrification. However, that study highlighted that different stakeholders had different minimum clearance criteria, which added ambiguity to the project’s preliminary design phase.

5.2.1 Feasibility of Progressive and Partial Electrification Schemes

The body of railway electrification literature generally takes an “all or nothing” approach to implementing electrification via traditional OCS with newly manufactured conventional electric locomotives over long distance corridors. Under such a scheme, few, if any, electrified trains can begin operations until the entire corridor has OCS installed and a substantial number of electric locomotives are manufactured, delivered, evaluated, and commissioned over the route. This greatly delays the realization of project benefits with the economic implications discussed earlier in this section. The 1983 TCS study for FRA highlighted this challenge by recognizing that, due to connecting lines, only a portion of the freight traffic on many corridors could be ultimately powered by electric locomotives. However, the same study made the simplifying assumption that one-half of each corridor could be operated by one-half of the required electric locomotives without any negative impacts at locomotive exchange points identified in later work for CARB. Strategies are needed to avoid these locomotive exchange impacts and convert a greater proportion of connecting freight train operations during initial phases of a project when a corridor is partially electrified, or for schemes that ultimately do not electrify an entire corridor.

Alternative locomotive technologies in place of newly manufactured conventional electric locomotives offer possible opportunities for electrified trains to begin operating earlier in the project timeline, improving economics. Later sections of this report investigate a variety of options such as: converting existing AC traction diesel-electric locomotives to full electric in place of purchasing newly manufactured locomotives; pairing AC traction diesel-electric locomotives with tenders that can house batteries or a pantograph and transformer to collect power from the OCS where available, but operate on diesel when OCS is not available and the batteries have been depleted; and development of true dual-mode or hybrid locomotives that produce full tractive effort and horsepower in either mode. Current DMLs are geared toward passenger service and typically have one mode with greatly reduced capability suitable for only short distance operations at lower speeds.

These types of locomotive technologies may alleviate the need for railway electrification to be subject to an “all or nothing” approach. In theory, as an interim step to improve the rate of return, OCS could be installed and energized over a portion of a subdivision, and trains with these alternative locomotive technologies could use the OCS to obtain electrical energy benefits over that portion of the route. The remainder of the route could be operated with conventional diesel propulsion or battery power if available to the locomotive via a dual-mode or tender option without the need for a time-consuming mid-route locomotive change. Such a scheme is termed “progressive electrification” while the extent of actual electrified operations progresses across the route as OCS is installed and electrified. Progressive electrification would initially provide small marginal benefits with little risk as short segments of OCS could be built quickly before traffic patterns shift, and only a few battery tenders or hybrid locomotives would need to be procured to begin accruing benefits. Electric operations could begin as soon as enough segments are powered to ensure that the electric energy efficiency along those segments outweighs the cost of carrying the battery’s dead-weight through non-electrified sections once the battery is depleted.

Eventually, if the OCS is completed and energized across the entire route, the convertible locomotives can revert to full electric locomotives or be replaced by dedicated electric locomotives to free-up the convertible locomotives to the next route undergoing incremental electrification, and the tender cars can be dispensed with for many trains. However, small fleets

of dual-mode or hybrid locomotives and battery/pantograph tenders may be needed to support trains that only traverse part of the main OCS corridor before diverging onto an unelectrified secondary route or branch line. If OCS is never completed across the entire corridor, or gaps are deliberately left between OCS sections to avoid construction through high-cost areas, the scheme is referred to as “partial electrification” or “discontinuous electrification.” While such schemes have been implemented on passenger corridors in various countries, later sections will explore if either of these approaches are feasible within the North American freight mainline operating context.

5.2.2 Signals and Clearance

Secondary technical challenges that require additional research involve the need to retrofit the existing signal system and increase clearances, both of which add to the overall capital costs of electrification and impact its economics, as described earlier in this section. Although many signal systems were replaced or improved during the installation of PTC, many lines that are potential candidates for electrification still use DC track circuits that are incompatible with AC electrification. Research is needed to determine whether newer coded and multi-frequency track circuit technologies, such as those proposed to support virtual block operations, can reduce the cost of replacing or upgrading track circuits for the purpose of AC electrification. A related research question is whether the installation of PTC in the form of the Interoperable Electronic Train Management System (I-ETMS) has introduced any new equipment with its own sensitivity to interference from installation of AC electrification.¹²

In addition to signal replacement, electrification costs are greatly increased when including the need to enlarge tunnels and through-truss bridges, and address clearance issues at highway overpasses and other overhead utilities by lowering the track (i.e., undercutting) or raising impacted structures. A challenge is that there is some ambiguity regarding the exact clearances required for 50 kV electrification of heavy haul freight lines. While railways have published desired clearances, states have laws setting minimal clearances, and various studies have introduced a different set of minimum practical clearances for 50 kV electrification. Uncertainty in the exact clearance requirements for 50 kV electrification creates uncertainty in the civil infrastructure costs to enlarge tunnels and lower track or raise or replace bridges where highways, utilities, and other obstructions pass over tracks. As discussed earlier, this uncertainty adds to the risk that the electrification project will not reach its forecast rate of return, decreasing its attractiveness as an investment.

Technical challenges surrounding 50 kV include understanding future rail clearance requirements (for example, if electrification would preclude future high-clearance traffic), and understanding the potential for switching between 50 kV electrification and lower voltages in urban settings where there could be significant public works savings.

Regarding the question of ROW sharing, one technical aspect requiring research is the amount of crash protection (e.g., the concrete crash walls installed around overpass support columns) that will be required for electrical transmission lines paralleling tracks within the ROW. It can be

¹² The NEC, which is by far the most significant portion of electrified rail in operation since the implementation of PTC, uses the unique Advanced Civil Speed Enforcement System (ACSES) system to implement PTC. This makes it difficult to draw conclusions about how electrification will affect the traffic control systems in use by Class I Freight Railroads.

assumed that constructing transmission lines within proximity to active freight rail lines will carry different costs compared to constructing transmission lines in open, undeveloped land. It is likely the case that the construction premium is more than compensated by savings in ROW acquisition, but understanding that the construction premium and the cost of alternative rights-of-way helps to quantify the value of ROW sharing agreements.

5.3 Institutional Obstacles

Various studies reviewed by the project team explored partnerships between utilities and railroads to share in the initial capital costs of railway electrification. However, the partnerships with the most progress were limited to private for-profit enterprises, such as preliminary agreements between the railroads and utility providers. Although the 1983 TSC study for FRA explored the cash flow implications of different tri-party financing arrangements, overall, there is a lack of an effective implementation strategy “template” for railway electrification featuring an economic partnership between railroads, utilities, and/or federal/state/local agencies that properly monetizes the costs and benefits accrued by each party. Providing ROW for new transmission to help decarbonize the power grid and support more widespread electric vehicle charging is a difficult type of benefit to internalize into a traditional cost-benefit analysis for a railroad capital project. Thus, research is needed to conceptualize new business models, partnership strategies, and multilateral agreements needed to facilitate the types of schemes that are most likely to result in feasible electrification projects, particularly in the event railroads are subjected to emission reduction mandates that require the elimination of diesel-electric propulsion on critical corridors.

Such a template should provide a clear rate structure that will be beneficial to both the railroad and the utility company. The railroad should have a reasonable expectation of energy cost savings compared to the cost of diesel fuel, and the utility company should be provided advantages through selling electricity to the railroad at a profitable rate or by gaining access to less expensive electricity (increasing the profits extracted from the utility’s existing customers) via distribution across rail ROW access. The public should benefit from net emissions reductions, either directly through reductions in rail diesel consumption, or indirectly via a cleaner electricity grid made possible through rail ROW sharing.

Both the SP studies from the 1960s and 1970s (in partnership with SCE and other southwestern utilities) and the TVA studies in conjunction with SR and L&N arrived at the framework of a separate corporate entity that would be directly responsible for the catenary (although the exact division of responsibilities varied). The 1983 TSC study for FRA offered a similar railroad-owned catenary subsidiary corporation arrangement as one possible financing option, but also suggested that a joint venture involving railroads, utilities, and the federal government could be structured with FRA serving as the primary catenary “owner.” Research into institutional frameworks to support electrification should focus on such methods whereby risk can be shared between stakeholders to ensure no single stakeholder shoulders the entire burden of a failed endeavor. One example that emerged multiple times from the case studies was railroads questioning their financial obligation if they chose to abandon the electrification in the future (or to shift traffic away from the line). The railroads expressed reluctance at being placed into a multi-decade payment obligation for electricity they may not use.

5.4 Summary

A conventional view of rail electrification studies might say that the 1970s oil crises motivated the freight railroads to investigate electrification, but oil prices settled before any of them reached the point of implementation. While that view is not incorrect, it is far from the full picture. As the preceding sections show, freight railroads and other stakeholders considered electrification for several reasons. The research team concluded that the primary reasons freight rail electrification has been rejected are:

- High up-front capital costs
- High risks due to the uncertainty of electrification in the North American context
- The presence of alternative investments that carry less risk

Over time, the focus of electrification shifted from a purely business case to more of an environmental one as more public agencies became involved. This is not to say that early studies ignored the environment, nor is it to say that recent studies have ignored the economics at play for private rail stakeholders.

Based on these findings, the following sections of this report analyze how new technologies or practices might make freight rail electrification more feasible, with a particular focus given to:

- intermittent electrification as a means of reducing the upfront capital cost, and
- ROW sharing agreements with electric utilities seeking to expand distribution, as a way of sharing risks and increasing the scope of project benefits.

6. Methods to Streamline Catenary Construction

In some cases, innovations discussed in this section might be relatively established. They are still included if they became established or were not in common practice when many North American freight Class I railroads last considered electrification in the early 1980s. This is due to the difference in economic results that would be likely from the inclusion of such innovations, were similar studies to be conducted today.

6.1 OCS Electrical Efficiency Improvements

For energy analysis, trains can be treated as a series of thermal processes which each have their own efficiency. Within diesel-electric locomotives, the largest energy loss occurs within the prime mover, which converts chemical energy stored within the diesel fuel into rotational kinetic energy of the drive shaft. That energy is in turn converted to electrical energy within the locomotive's alternator in the form of an AC current. Electric locomotives begin with an alternating current along transmission lines, with energy losses as the voltage is stepped-down at substations, and further losses along the OCS. The remaining processes (and efficiencies) are similar between the two locomotive types, with AC current within the locomotive converted to DC current at a rectifier, which is then converted back to AC current in an inverter, which is finally converted to rotational kinetic energy within the AC traction motors. From an energy accounting standpoint, the primary difference between the overall energy efficiency of a diesel-electric locomotive versus an electric locomotive is due to the higher efficiency of delivering energy via OCS versus a diesel prime mover (Hoffrichter, Miller, Hillmansen, & Roberts, 2012) (DiDomenico & Dick, 2015).¹³

Because the electrical transmission through the OCS plays a crucial role in the overall efficiency of the trains that will be using the OCS, capital expenditures that improve the OCS's efficiency might pay for themselves over the life of a project in the form of lower energy expenses. One of the primary ways to improve an OCS's energy efficiency is by using a higher voltage, as discussed in the next section.

6.1.1 Higher Voltage

Due to Ohm's Law, for a given resistance which is related to the length, shape, and material for the OCS, the power lost to transmission is directly proportional to the square of the current. To minimize the power losses due to transmission, it is necessary to minimize the current, which can be achieved by using a higher voltage. Over time, electric railways have used higher and higher voltages due to this fundamental physical relationship. For this same reason, modes of electrification that restrict the maximum voltage, such as using a third rail, lead to much greater transmission power losses, and are therefore less efficient.

For the power requirements of freight rail, using higher voltages can lead to large power savings in the long run. Additionally, higher voltage allows for substations to be spaced further apart. While higher voltages require more expensive electrical equipment for each substation, the

¹³This type of analysis can become quite complex as it is broken-down further. For example, it is possible to analyze the efficiency of producing the electricity, compared to the energy used to produce and transport the diesel fuel.

overall number of substations is reduced, which can make the upfront capital cost of one voltage configuration versus another complex to calculate.

6.1.2 Lower Frequency

Modern railway electrification proposals in North America typically consider single-phase 25 kV or 50 kV AC power at 60 Hz to match the standard frequency of the three-phase commercial electricity supply. A single-phase railway traction power system has the disadvantage of unevenly loading the phases of the external commercial power system, leading to potential problems with unbalanced voltage and local power quality. However, mitigating this issue by distributing all three phases of AC electricity to a moving locomotive via a poly-phase AC system is complex, and has only seen limited applications in Europe and Brazil (Elbelkasi, Badran, & Abedl-Rahman, 2020).

A more common alternative is to use a low frequency AC system, such as the 16.67 Hz systems found in Sweden, Germany, and other European nations. A low-frequency system potentially reduces electrification costs in several ways. The first is that the inductive voltage drop in overhead catenary line systems is reduced at lower frequencies. For example, a 15 Hz operation would have approximately one-quarter of the inductive voltage drop as a 60 Hz operation, allowing for distances between substations to be increased by a factor of three or four based solely on voltage drop. Given that other factors influence their location, the number of substations required for a low frequency AC system might be reduced by 30 to 40 percent compared to a 60 Hz system (Bhargava, 1999).

The second benefit is that with fewer inductive losses, the system voltage can be decreased from 25 kV to the range of 16 to 16.5 kV. Lower voltages have reduced clearance requirements, potentially eliminating civil engineering expenses to lower existing tracks or modify bridges and tunnels with insufficient clearance for 25 kV OCS. Finally, the lower frequency effectively spreads the single-phase railway traction loads over multiple phases of the higher-frequency commercial power system, creating more balanced loads with reduced impact on power quality.

The main challenge of a low frequency AC system is that the system must either use its own generation and transmission supply system that is isolated from the commercial grid, or use specialized equipment to reduce the frequency of supplied commercial power. Historically, the lower frequency was obtained using rotary frequency converters, large machines that are expensive to acquire and maintain. The need for this specialized equipment, in comparison to simple direct transformation substations connected to 60 Hz commercial power, were one reason a 25 kV 60 Hz AC system was selected over a low frequency system for the Muskingum Electric Railroad in the late 1960s, becoming the first such installation in the Western Hemisphere (Oliver, Ross, Cowal, & Thompson, 1971). Since that time, the advent of modern power electronics has led to the development of static frequency converters with no moving parts that are far more economical and do not require ongoing maintenance, making low frequency systems more attractive (Wales & Wilson, 2023). Another issue with the frequency conversion process was its tendency to create harmonics in the electricity delivered to the locomotive, potentially damaging the electrical equipment and leading to premature failure over time. Fortunately, modern electric locomotives have appropriate onboard electronics to filter these harmonics and correct the power factor, lessening these concerns (Bhargava, 1999).

Given these factors, both 15 kV 15 Hz AC and 25 kV 15 Hz AC systems have been suggested as potential options for electrifying North American freight rail operations (Bhargava, 1999). The 15 kV 15 Hz system could likely supply trains with up to 20 MW of power, while the 25 kV 15 Hz system could likely supply a train with 25 MW of power, both roughly equivalent to the power supply capabilities of a 25 kV 60 Hz system. From an overall economic framework standpoint, the potential benefits of implementing a low-frequency system must be balanced against the additional cost of the equipment required to convert the commercial power grid frequency to that desired for the electric traction operation.

6.1.3 Autotransformers

Autotransformers allow for longer distribution distances without using as high of a voltage. Figure 14 shows a simplified electric diagram for an autotransformer system under consideration in the 1992 SCRRRA rail electrification study for the Los Angeles basin (Southern California Regional Rail Authority, 1992, pp. 5-8).

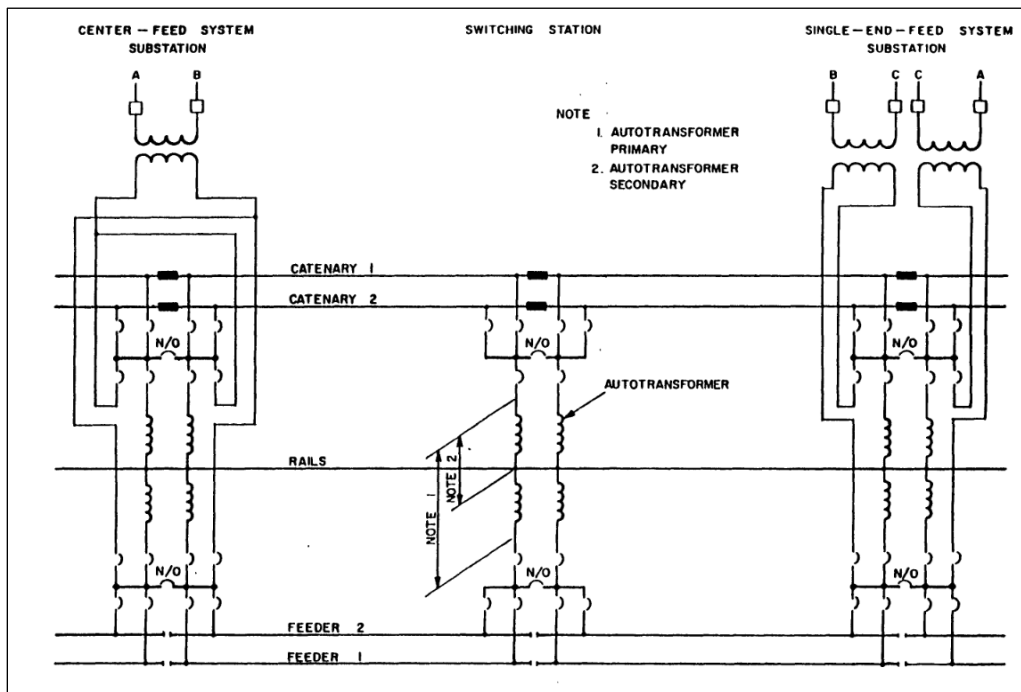

Figure 14. Simplified Electric Diagram for an Autotransformer System Considered in the 1992 SCRRRA Rail Electrification Study

The autotransformer system originated in the United States in the early 1900s but was soon discontinued. While it saw renewed use for passenger rail in Japan in the 1970s and France in the 1980s, it was not included in most of the North American freight rail electrification projects of those times (Courtois, 1993). The SCRRRA rail electrification study for the Los Angeles basin in 1992 considered a 25 kV autotransformer system as one alternative, although the study noted that the overall cost for such a system was higher per unit distance at the time. According to the study, due to its higher general cost, the autotransformer system should not be the preferred alternative, but its compatibility with a 25 kV conventional OCS could make it useful “in areas where distances between utility power supply points necessitate a longer traction substation

feeding distances than possible with a system without autotransformers” (Southern California Regional Rail Authority, 1992, pp. 5-2).

6.1.4 Adjustable Voltage

Modern traction transformers can accept different input voltages. For example, Amtrak’s NEC uses 25 kV AC at 60 Hz between Boston, MA, and New Haven, CT; 12.5 kV AC at 60 Hz from New Haven, CT, to New York, NY; and 12 kV AC at 25 Hz from New York, NY to Washington, DC. Past studies considered one electrification voltage for the entire project, typically 25 kV in earlier freight electrification studies, and then 25 kV or 50 kV in later studies. 50 kV electrification results in less power loss across the OCS, which saves energy over time, and allows for greater substation spacing, meaning fewer substations need to be built (this effect is discussed at length in [Section 6.1.1](#)). Meanwhile, higher voltages also require more expensive electrical hardware and greater clearances due to the need for a wider air gap between the energized OCS and nearby grounded metal objects such as bridge trusses or tunnel supports. This means that higher voltages require more clearance overall, which can lead to large upfront capital expenses in some settings.

As an example, the SCRRA study performed a comprehensive inventory of overhead obstructions throughout the rail corridors being analyzed in the Los Angeles basin. The study identified 265 bridges crossing the rail corridors, and determined whether each bridge would require no intervention, lowering of the track, raising of the bridge, or full replacement of the bridge. [Table 18](#) (repeating the information in [Table 9](#) for convenience) shows the results of that analysis for 25 kV electrification and 50 kV electrification at three different clearance standards. The 50 kV electrification option would have required far more and far more intrusive interventions, significantly increasing the project’s overall cost, as well as increasing the likelihood of construction delays.

Table 18. Crossing Bridge Interventions in the SCRRA Study

Intervention	25 kV		
	Minimum Clearance	Desired Clearance	Railroad Requested Clearance
No Action Required	195	153	42
Lower the Track	62	95	162
Raise the Bridge	8	17	61
Replace the Bridge	0	0	0
	50 kV		
No Action Required	52	40	38
Lower the Track	185	151	131
Raise the Bridge	28	74	92
Replace the Bridge	0	0	4

With modern traction transformers, it might be possible to lower the OCS voltage for substations in urban areas (e.g., the Los Angeles basin), avoiding costly capital projects there, while increasing the voltage for rural substations. This would allow for a modern electrification project to achieve the greater efficiencies and lower substation construction costs associated with higher voltages where possible.

Because transformers capable of accepting multiple voltages are more complex and commensurately larger, this option might not be compatible with all locomotive technologies. As will be discussed in subsequent sections, modern locomotives have significant restrictions on the weight of additional components. If a new electrification project intends to save on locomotive acquisition by converting existing diesel-electric locomotives, further investigation will be required to determine the feasibility of designing an electrified freight network with multiple voltages.

6.2 OCS Design and Construction Improvements

As the North American rail industry moved toward electrification in the early 1980s, railroads expected improvements in OCS design and construction methodologies (Hayes, 1984). Because the expected electrification projects were not built, those economies of scale and improved methodologies never accrued in North America. However, international experience has continued to advance OCS design and construction in the context of passenger and high-speed rail corridors (Railway Industry Association, 2019). Although promising, the lack of heavy haul freight experience makes it difficult to quantify how much these design and construction improvements will change overall OCS construction unit costs for North American mainline freight electrification.

6.2.1 Pylon Optimization

One way to potentially reduce the cost of OCS is to ensure that the system is not over-designed for the exact loads being imparted on the OCS and supporting structures. Hayes (1984) noted that considerable scope exists for economizing new catenary designs compared to legacy designs used for electrified rail systems like the NEC between Washington DC and New York. A recent study in the UK noted that both the pile foundations and structural pylons supporting OCS on the Great Western electrification project were substantially overdesigned (Railway Industry Association, 2019). In addition to directly increasing the cost of materials and installation for the pylons and their foundations, the excessive length of the pile foundations decreased the daily productivity of the OCS construction train to levels 50-60 percent below target, leading to schedule delays and cost overruns.

Standardized support structures and spacing can reduce the need to carry out intensive structural design and analysis at each support location, but may incur unnecessary material and construction costs. A more rigorous design and analysis effort can produce custom support structures and spacing that optimize materials and costs, particularly for curves and junctions or interlockings where multiple tracks diverge or intersect. However, such an effort may require additional design time and costs, with hours spent on each structure. Saa et al. (2012) describe a high-performance computing tool for calculating and optimizing the design of railway OCS support structures. Garcia et al. (2013) claim the system can design structures in as little as 13 seconds, reducing the design time by 82 percent compared to conventional methods.

In addition to the structural design of the pylons and foundations, an important consideration is using the longest spans possible between support structures. Hayes (1984) reported that by carefully matching the design of the OCS to the loading gage of the freight equipment and pantograph width, spans as long as 300 feet were employed for the 50 kV electrification of the Desert Western Railway. The long spans, combined with the use of wooden poles and synthetic

insulators, reduced the cost of electrification of the 38-mile railway to \$150,000 per mile when completed in 1983, or roughly \$300,000 per km (\$480,000 per mile) today.

6.2.2 Alternatives to Bridge and Structure Clearance Modifications

Many tunnels and bridges crossing over freight rail lines were not designed with clearances for electrification in mind, and if they were, that allowance was likely consumed by the adoption of double-stack container railcars on many corridors during the 1980s. To facilitate traditional electrification with OCS requires clearance for both the wires and the pantograph mounted on top of electric locomotives to collect current. In addition to physical clearances for this equipment, sufficient space must be allowed between the contact wire and the top of the train, and between the contact wire and the low chord of bridges and tunnel ceilings to prevent arcing of electrical current. Required clearances are typically obtained by lowering the track where possible. Nearby constraints (e.g., culverts, railroad bridges, grade crossings, etc.) may prevent track lowering, or previous clearance projects to facilitate double-stack container clearance may have already consumed clearance gains possible through track lowering. In these situations, the overhead bridges (i.e., tunnel ceilings) must be raised or, where not possible, completely reconstructed. These civil construction works can greatly add to the capital costs of freight rail electrification via OCS.

For most electrification projects, modifications to overhead structures are dictated by the desire of railroad operators to maintain standard wire heights and clearances from wires to structures regardless of the local conditions and associated safety risks (Railway Industry Association, 2019). However, in many cases, if physical pantograph and wire requirements are met, the specifics of the site may allow for safe operation with substandard clearances without introducing the risk of arcing or other concerns, eliminating the cost of raising or reconstructing the bridges at these locations.

The 2019 UK study advocated for risk-based design and evaluation of various innovative solutions to the problem of constructing OCS under overhead structures with the aim of minimizing the number of instances and associated cost of modification or reconstruction to accommodate electrification (Railway Industry Association, 2019). The 2019 UK study lists a range of possible designs that can reduce clearances to the minimum physical space required for the pantograph. The possible design and construction options include:

- Under bridge arms to support the OCS at shallower standoff distances
- Surge arrestors to reduce the clearance required to prevent flashover
- Insulated contact wire cover to reduce the clearance required above the OCS
- Insulating coating applied to the bottom of bridges to reduce required clearance
- Bar conductor (particularly in tunnels)
- Neutral sections with no voltage/current to eliminate arcing concerns but with continuous OCS contact wire to avoid the need to lower and raise the pantograph under structures
- Discontinuous (i.e., partial) electrification with short or long gaps in OCS that encompass bridges and avoid the problem altogether (as discussed in later sections of this report)

Implementing a combination of these design and construction options can potentially reduce the incidence of clearance-related civil construction costs for freight rail electrification projects.

6.2.3 OCS Construction Trains

Work trains for the purpose of constructing and maintaining OCS have been developed to carry out all phases of OCS construction, from placing foundations and erecting pilings, to stringing overhead wire (Railway Industry Association, 2019). Like the use of track laying machines for the construction of track along a roadbed, catenary construction machines have the potential to construct OCS faster, at less expense, and with high quality. Using this integrated approach, as opposed to individual task-specific crews and equipment, potentially increases the overall productivity of construction work windows and reduces the amount of downtime track sections experience during OCS construction, as well as downtime for maintenance over the life of the project (Hestra-Verlag, 2000). Because OCS is likely to be constructed along corridors with high traffic densities, schedule disruption can be costly for railroads. More productive use of construction work windows can also potentially reduce the overall schedule duration, allowing OCS sections to be energized and benefits of electrified train operations accrued earlier in the overall project timeline.

6.2.4 Approaches to Avoid Line Disruption During OCS Construction

Weiss et al. (1983) note that the per-mile costs quoted for many railway electrification projects are for systems that are electrified during the construction of new lines. Under such conditions, the OCS can be installed efficiently as part of the overall track construction process. For existing lines, the OCS must be constructed in such a way to minimize disruptions to exiting rail traffic. This is particularly challenging because the freight lines where electrification via OCS is likely to be most economical will also be those with the highest traffic density, and thus the most difficult to obtain extended work windows for efficient OCS construction. Weiss et al. (1983) suggest that the per-mile costs of OCS could double if track access is difficult and work periods are short. However, Weiss et al. also note that these effects can be mitigated through good planning, experience, and proper OCS installation equipment.

In addition to the OCS construction trains described above, other construction techniques have been implemented to minimize line disruptions and maximize the productivity of available work windows. In Australia, in locations where road access is difficult, surrounding lands have environmental concerns, or long distances to staging tracks make rail transport of materials disruptive to regular train operations, helicopters have been used to efficiently install OCS pylons and string overhead wire on heavy haul freight electrification projects (Wales & Wilson, 2023). While rail-based installation equipment (or road-based equipment fouling the track while operating from an isolated parallel access road) cannot quickly clear single-track segments in advance of approaching trains, helicopters with a smaller crew on the ground are a more agile alternative and can clear quickly and maximize the productivity of available track time.

Similarly, mobile hydraulic “skylift” work platforms parked outside the “foul zone” but equipped with extended long reach arms to position workers near pylons and OCS work locations can quickly move workers and equipment clear of the tracks to allow for passing trains (Wales & Wilson, 2023). In Australia, long reach pile-driving and drilled shaft equipment has also been used to install OCS pylon foundations with minimal, if any, intrusion on the safety distance from the nearest track required to allow workers to continue construction tasks while a

train is passing. This ability has led to accelerated project schedules and reduced electrification costs.

6.2.5 *Design-Build and Other Project Delivery Approaches*

During the 1960s through the early 1980s, when many of the past electrification studies reviewed in this report were conducted, the common approach for construction projects was “design-bid-build.” Under this approach, an engineering firm, in cooperation with specifications developed by the railroad and utilities, would design the electrification system and then, once design was complete, issue it to bid for construction by a contractor. For complex projects such as electrification that require extensive systems integration and interfaces between different trades (e.g., civil/structural and electrical), this approach can be inefficient because during the design phase there can be great uncertainty in many facets of the system that are highly sensitive to existing site conditions. Often, as the contractor begins construction, different existing conditions are encountered, or more detailed information is made available, requiring a modified design. Under “design-bid-build,” these cycles of design modifications are time-consuming and can substantially delay construction, adding cost and risk to the project. Past estimated costs of railway electrification are likely reflective of this approach to construction and its associated costs and schedule implications.

Since the 1990s, it has become increasingly common for complex construction projects to be conducted using alternative project delivery mechanisms, such as “design-build.” Under this approach, a single contractor would be responsible for both design engineering and construction of the electrification to meet a specification developed by the railroad and utilities. The design and construction processes usually overlap, with information collected during initial site preparation used to better inform detailed design decisions. In addition, with an integrated design and construction team, design changes prompted by field discoveries can be implemented in a more efficient, streamlined manner, lessening schedule impacts. The designers also have a stronger incentive to consider “constructability” of the project in addition to cost and schedule when creating the design, reducing the likelihood of delays and cost overruns.

According to a US DOT study comparing “design-build” to “design-bid-build” for highway projects, implementation of “design-build” resulted in an average 14 percent reduction in project duration, and an average 3 percent reduction in project cost with no appreciable difference in project quality (AECOM, 2006). Both outcomes from adopting design-build would improve the economics of modern options for freight railway electrification.

Since mainline freight railway electrification projects will involve the purchase of new locomotives, design-build approaches can be taken a step further to “design-build-procure.” Under this project delivery mechanism, one entity is also tasked with procuring the locomotives in addition to design and construction. By using this approach, the design of the electrification infrastructure and locomotives can be better matched, reducing wasteful overdesign and ideally reducing costs. This approach was recommended for the Caltrain electrification project (Caltrain & STV Incorporated, 1998) and was highlighted as a key electrification cost-reduction strategy in a recent UK study (Railway Industry Association, 2019).

The “design-build-operate-maintain” (DBOM) or “design-build-finance-operate-maintain” (DBFOM) alternative project delivery methods are similar to proposed electrification financing models that reduce railroad capital investment through the formation of a subsidiary company or

separate entity to construct and own the electrification infrastructure and recoup costs via a “per kWh” charge to the railroads. DBOM and DBFOM have been successfully implemented for many tollway and electrified rail transit and commuter rail projects. Examples include DBOM for the Hudson-Bergen light rail system in New Jersey, and DBFOM for the Denver Regional Transportation District (RTD) FasTracks Eagle P3 project to construct an electrified commuter line between downtown Denver and Denver International Airport (Goetz, Jonas, & Brady, 2016). These approaches offer further cost and schedule reductions over design-build, and substantially change the required railroad investment and risk burden of a modern freight electrification project.

6.2.6 Standards, Experience, and Electrification Industry Maturity

Several of the historical electrification studies reviewed by the project team cite a lack of North American freight experience with design, construction, and operation of electrification as a major source of cost uncertainty and risk. Without a steady flow of electrification projects, an ecosystem of designers, contactors, and manufacturers with freight rail electrification experience has not developed or matured. Without a sustained freight rail electrification industry, there is a lack of best practices and proven, standard “off the shelf” designs and approaches for US mainline freight applications. Because of this lack of experience and standards, each electrification study tends to start from scratch and attempt to “reinvent the wheel” with custom design elements that increase development costs and the risk of project implementation problems, schedule delays, and poor performance, which collectively have a negative impact on the economics of the project.

A similar situation has occurred in the UK where mainline electrification has been undertaken sporadically over time. Although multiple electrification projects have been implemented in the UK over the past several decades, the projects are not frequent enough to sustain a domestic rail electrification industry, and sufficient time passes between projects for institutional knowledge to be forgotten or made obsolete by changing technology and regulations. Each project tends to develop its own non-standard designs, adding research and development cost and time, and making overall project management and integration more difficult.

A recent UK study (Railway Industry Association, 2019) attempted to quantify the impact that a lack of standards, experience, and mature electrification industry has on the cost of electrification projects in the UK. The study compared the cost of the UK electrification projects conducted at sporadic intervals to similar projects in Germany and other European countries as part of sustained, long-term electrification programs that have fostered a domestic rail electrification industry. The results of this comparison suggested that electrification costs were 33 to 50 percent lower when conducted as part of a sustained electrification program that supported development of a mature design and supply industry. Widespread implementation of electrification on US freight rail corridors is likely to facilitate similar cost reductions through economies of scale and other efficiencies arising from development of standards and the experience of a mature design and supply industry.

6.3 Alternatives to OCS

Within the broader discussion of electrification, it is worth exploring the primary technologies at play and their alternatives. Electrification via OCS remains the most feasible infrastructure-based

technology for rail decarbonization versus locomotive-based technologies such as fuel cells or batteries, but this section outlines the broad concepts behind two alternatives to OCS.

An electrified railway requires transmission of electrical power from the utility connection onto specific tracks to power locomotives. The locomotives can be:

- electric (with or without last mile propulsion batteries to operate short distances in the absence of electric infrastructure), or
- battery-electric or hydrogen fuel cell with batteries (sometimes designed with mobile recharging capability).

There are three basic configurations of electrical energy transmission infrastructure to bring electrical power to locomotives:

1. **OCS** use a conductive energized wire positioned above the track suspended from a catenary guide wire. The power passes from the OCS through the electric locomotive via a pantograph on the locomotive roof and leaves through the running rails (which act as the immediate current return).
2. **Third rail systems** use a conductive energized power rail installed slightly above the ground and adjacent to the track, with power passed from the third rail to the electric locomotive through a shoe and again returning with the running rails as the immediate return current path.
3. **Inductive charging systems** are contactless, instead using magnetic induction to pass energy from a charging plate (located between the rails but below the top of rail) to the locomotive. Alternative arrangements may include positioning the charging plates above or alongside the locomotive, but both alternatives are unlikely to find applications.

Figure 15 shows an example of dual electrification, in which both an OCS and a third rail are present.



(The third rail that other trains use is visible beside the track. Creative Commons photo by Hugh Llewelyn accessed via Wikimedia Commons)

Figure 15. Train Running with OCS Along a Dual-electrified Rail Line with Third Rail

6.3.1 Overhead Contact Systems (OCS)

Globally, OCS is the most common and technically mature type of electrification infrastructure for railways moving freight, passengers, or a combination of both. OCS electrification (i.e., the electrification infrastructure and the electric locomotive) has differing features, depending on the use of DC or AC from the utility. AC OCS with AC-motor electric locomotives (which most modern locomotives use) requires a complex combination of hardware and technologies.

AC electrification is recommended for heavy freight rail electrifications, as DC electrification has more limitations:

- AC allows voltages as high as 50 kV, whereas DC is typically limited to 3 kV; for the same locomotive power demand, a DC system will need to handle significantly greater current than AC, resulting in more power loss.
- Because of the lower current required, AC contact wires and overhead structures (e.g., poles, towers, etc.) can be lighter weight and simpler, reducing cost.
- Fewer substations are required with AC, reducing capital expenses further.

AC electrification at 50 kV requires significantly more insulation (both for OCS structures as well as onboard the locomotive) than 25 kV AC; however, overall energy efficiency can improve with higher OCS voltage. New and modernized electrified railways globally are generally energized with 15 kV (in the UK and EU), 25 kV, or 50 kV AC. Electrifications increasingly use commercial-frequency high-voltage AC (50 hertz in Europe and elsewhere, or 60 hertz in North America).

Rail electrification can have adverse impacts on adjacent communications and ferrous structures unless proper insulation or other mitigating measures are designed and built into an OCS electrification. Mitigations must be included to address issues such as:

- Unsafe generation of stray electrical currents through arcing
- Electrical erosion of metal structures
- Interference with communications signals

A more thorough discussion of the intricacies of OCS design can be found in “Overhead Line Electrification for Railways” by Garry Keenor (2021). Later sections of this report delve into different forms of discontinuous OCS electrification.

6.3.2 Third Rail Systems

Third rail power transfer is commonly used globally in the passenger rail transit industry. The most common applications are on urban subway systems and certain heavy-rail passenger systems typically operating in isolation from freight railroads. There are, however, some third rail applications that are co-located with heavy-rail passenger and freight operations.

In third rail applications, the eponymous third rail is typically outside and slightly above the other two, as shown in [Figure 16](#) (Fong, 2020). This is the most common configuration of third rail hardware in the US, where there are numerous recommended but no mandatory standards. Regardless of the configuration chosen, close attention is required to maintain dimensions to minimize the risk of interference between the third rail structure and the pick-up shoe installed on locomotive trucks (i.e., bogies) through which electrical current passes from the third rail.

One area where there is considerable variance in design is the point of contact between the shoe and the third rail. Some systems suspend the third rail from above so that the shoe slides underneath it, while others have the shoe slide along the top with or without a cover over the third rail (Figure 16 illustrates top contact with a cover). Still other systems have the shoe slide along the side of the third rail. The lack of standardization means that a given locomotive equipped with third-rail shoes might not be able to traverse a given third-rail system.

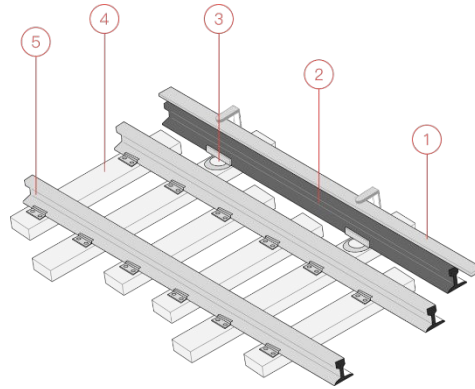

Figure 16. Typical Third Rail Layout with Coverboard (1), Power Rail (2), Insulator (3), Sleeper (4), and Tracks (5) (Fong, 2020)

With respect to freight rail applications, there are several reasons why third rail electrification is not common nor recommended.

6.3.2.1 Safety

Safety is the first concern for any rail application of energized third rails. Although differences in how third rails can be installed affect the contact risk between a person and the energized third rail, third rail applications in general create more contact risk than overhead catenary. The bottom-contact configuration in which the third rail is suspended so that the shoe slides along the bottom of the third rail generally creates less risk of accidental contact, but it is also more complex, particularly in the design and maintenance of the locomotive shoe.

The risks of electrical arcing between the third rail contact surface and the locomotive contact shoe are also relatively high with third rail systems when compared to OCS installations. Figure 17 shows such arcing on the London Underground (SPSmiler, 2005). This arcing can cause injuries such as high-energy flash burns (Lisinski, 2023), and is also a potential fire hazard. Arcing is also prevalent in areas where snow and ice may form during cold ambient temperatures.

In a freight rail environment, the presence of an energized third rail creates significant safety risks for railroad employees who often work both on the ground and while riding the steps of a locomotive. This includes situations such as climbing off or onto a locomotive, requiring careful foot placement to avoid the third rail. Additional risks involve maintenance personnel performing work on the track structure.



Figure 17. Visible Arcing Between the Lead Rail Vehicle’s Shoe and One of the Energized Rails on the London Underground (SPSmiler, 2005)

6.3.2.2 Power Limitations

Power limitation is the second concern, simply because third rail transmission is typically limited to about 1,000 volts to limit arcing between the energized third rail and the closest of the two normal rails. Because power is the product of voltage and current, if voltage is limited, current must rise for a given power level. Compared to an OCS installation, where voltages can be as high as 3 kV DC (as in the former-Milwaukee Road electrification in Montana, Idaho, and Washington state) or 50 kV AC (as on contemporary rail electrifications), third rail systems would require such high current for the power levels needed for freight applications that there would be significant power lost to heat. The high current would also require more frequent substations to maintain voltage since the electric potential falls according to the third rail’s internal resistance.

Third rail applications in the northeastern US are typically energized at 650 or 700 volts DC, and the third rail power systems may have 4,000 amp circuit breakers. A 650-volt DC system with 4,000 amp circuit breakers implies a maximum power capability of 2.6 MW (3,485 hp), which is less power than a single freight locomotive might require.

6.3.2.3 Network Compatibility

The third and final concern about third rail in freight operations is network compatibility. While an existing train can operate underneath OCS with no change to service, this is not always the case with third rail. The third rail can infringe on the train clearance envelope (clearance plate or “loading gage”) for freight trains, particularly the snowplows at the front of locomotives. Diesel-electric locomotives of the New York & Atlantic Railroad operating in third rail territory of the MTA in New York City must use modified snowplows with trimmed corners to provide clearance for the third rail power system (Anacostia, 2024).

6.3.3 Inductive Charging Systems

Inductive charging systems have been installed on a limited basis for recharging transit buses and energizing light rail transit trams in urban locations to avoid energized overhead wires or third rails in areas frequently occupied by people.

The basic principle of inductive charging involves a coil of wire through which electricity is passed, inducing a strong magnetic field. A second receiver coil, mounted on a vehicle, generates a current when it passes over this magnetic field.

An obvious advantage of below-the-vehicle inductive charging is that highly visible infrastructure such as overhead catenary and trackside third rail is eliminated. A disadvantage of inductive charging is that, even in ideal conditions, it is less efficient than equivalent conductive charging infrastructure. Heavy rail operations produce large amounts of dust and debris, which can include deposits of fine iron oxide particles (wear particles from physical contact between brake shoes-and-wheels and rails-and-wheels) as well as normal ambient particles, which can affect the strength of the magnetic field.

Inductive charging technology will be improved over time. However, it is not currently feasible for freight rail applications (such as stationary battery charging and especially in-motion battery charging) since inductive recharging hardware is still in the R&D phase, and the rate of power transfer is limited compared to other charging methods

6.3.3.1 State of Research for Inductive Charging in Rail Applications

Despite the challenges described above, research continues into inductive charging to eliminate the need for the overhead catenary system and its associated costs. Xu (2022) examined the potential for wireless power transfer (i.e., inductive power) technology to support railway applications. Xu noted that while most research on inductive power transfer for transportation applications has been for light-duty passenger and transit vehicles, railway applications are attractive because the fixed guideway solves one critical challenge: maintaining proper alignment between the wayside power transmitter and the receiver mounted on the vehicle. Misalignment between these components greatly decreases the efficiency of the power transfer, particularly if implemented for power transfer to moving vehicles as opposed to stationary charging applications. Winter et al. (2013) further noted that eliminating OCS through inductive power would have additional benefits of reliability due to the elimination of contact wear, not being susceptible to the environmental effects of snow, ice, and extreme heat, and the inherent redundancy of the ground-based transmitter system compared to the less resilient OCS.

A critical challenge to inductive power transfer for railway applications is maintaining high efficiency while supporting high power transfer at suitable “air gap” distances between the transmitter and receiver. The Korea Advanced Institute for Science and Technology (KAIST) proposed and optimized several inductive power charging designs for rail applications, reaching a power rating of 100 kW at an air gap distance of 26 cm (~10 inches) and 80 percent efficiency (Shin, J. et al, 2014). While suitable for some rail transit “tram” applications that mainly charge battery-powered vehicles during station stops, the power levels are not yet able to support the demands of moving North American freight locomotives. KAIST has demonstrated a 1 MW inductive power transfer system at 83 percent efficiency, but the required air gap is only 5 cm (~2 inches) (Kim, J. H. et al, 2015), which represents an unfeasible configuration for freight rail applications due to clearances and tolerances required for transmitters placed between the rails. Thus, in the short term, inductive charging is not a feasible replacement for OCS in the context of freight rail electrification.

Even if an effective inductive system could be developed to transfer ~3 MW of power to a moving locomotive across an acceptable air gap distance at reasonable efficiency, it is unclear if

such an approach would require additional or less infrastructure and cost than an overhead catenary system. Although the catenary structural support system and pylon foundations would be eliminated, an inductive system would require continuous transmitter plates and inductive coils running down the middle of each mainline track. These continuous transmitter plates and coils may represent a net increase in material compared to the relatively small diameter contact wire over each track in a traditional overhead catenary system. From a practical standpoint, the presence of transmitter plates on top of the crossties would be an impediment to track maintenance activities, as the plates would need to be removed and carefully re-installed during certain types of track maintenance. The inductive power transmitter can be incorporated into a slab track system, but such an approach would require reconstruction of the track structure. In the long-term, as inductive power technology improves, these systems could provide a way to avoid the visual impacts of OCS in sensitive areas, or provide another option for maintaining power through segments where overhead clearances make OCS impractical.

6.4 Estimated Cost Savings Summary

Overall, OCS is still the best existing infrastructure technology for freight rail electrification. Its primary downside, the large upfront capital costs it imposes, can be partially mitigated by several of the techniques discussed in this section.

6.4.1 Substation Costs

Using high-voltage, low-frequency AC electricity can significantly reduce the number of substations required for a given project. According to SCRRA's analysis for freight rail electrification in Los Angeles, increasing the voltage from 25 kV to 50 kV can increase the maximum distance between substations by as much as a factor of four due to smaller voltage drops for each train, and each train being able to operate with a higher absolute potential loss (1992, pp. 5-21). Bhargava estimated a 30 to 40 percent reduction in the total number of substations required by reducing the frequency of the AC current to reduce inductive voltage drops (1999). While higher voltage and lower frequency can both reduce the total number of substations required (along with the requisite transmission costs to link each substation with the electricity grid), they do lead to higher component costs in each substation. This presents an optimization problem with the potential to significantly reduce the overall cost of OCS electrification.

One further potential benefit of using lower frequency is that the same equipment used to lower the frequency of electricity from the grid would enable regenerative energy from trains to be returned to the grid – without specialized equipment, railroads require another train somewhere else on the system able to accept regenerative energy.

6.4.2 OCS Costs

Simultaneously, using refined pylon designs and other modern best practices with design models that did not exist 20 years ago can reduce the materials and labor necessary for OCS construction. These benefits can be compounded by alternative project delivery methods (e.g., design-build) that have been shown to reduce the cost and schedule duration of complex construction projects. OCS costs are also expected to decrease substantially if a sustained program or programs of freight rail electrification can lead to the development and maturation of a domestic freight rail electrification design, supply, and construction industry in North America.

6.4.3 Civil Infrastructure Costs

Adjusting the voltage across an electrification project would require locomotives capable of accepting multiple voltages, which will increase locomotive costs. However, changing the voltage can greatly reduce the amount of civil infrastructure reconstruction required. Because of the long-term benefits involved with using flexible current configurations curated to specific corridors that have already been discussed (see [Sections 6.1.1](#) and [6.1.2](#)), it is likely that the infrastructure construction benefits of using flexible voltage outweigh the locomotive equipment costs. Additionally, such locomotives will allow for more flexibility as the North American freight rail industry gains experience with electrification and settles on which standards work best. As early as 1984, Hayes suggested, “The increased cost of dual-voltage electric locomotives capable of operating at both 50 and 25 kV is relatively small compared with the potential savings in providing additional electrical clearance for 50 kV or the additional substations for 25 kV” (1984). Using lower voltages to avoid costly bridge replacements would dramatically reduce the variability and planning risk in the cost of rail electrification projects. When combined with dual-mode or battery-hybrid electrification techniques discussed later in this report, future freight rail electrification projects might be able to avoid nearly all clearance-related project costs.

6.5 Technological and Commercial Readiness

The methods to streamline OCS construction presented in this section are all at various stages of research, development, and implementation in the context of mainline railway electrification, most commonly for international passenger applications or domestic commuter and rail transit systems. The level of technology development and commercialization can greatly influence the uncertainty in its costs, benefits, and performance, and the time required to further develop, test, deploy, and apply a technology to actual freight rail electrification projects. The combination of added uncertainty and time leads to different levels of risk for the various technologies and approaches discussed in this chapter.

To evaluate the level of technological development of various methods to streamline OCS construction, [Table 19](#) shows the Technology Readiness Level (TRL) scale FRA uses to rank research projects (Federal Railroad Administration, 2023). The bottom end of the scale (TRL 1) corresponds to “blue sky” research. The top end of the scale (TRL 9) indicates that a technology has been successfully deployed in a field “prototype” setting and does not need further development or design refinement. However, TRL does not gauge the progress of this fully developed but potentially “one off” prototype technology toward commercialization, where a final product can be purchased “off the shelf” on the open market. There are many technologies that, while fully functional and proven in prototype form at TRL 9, never reach commercialization and wide-scale application for many economic and practical reasons. Only when the OCS-related technologies presented in this section reach the status of a viable commercial product in production can they reliably be counted on to consistently deliver benefits to freight rail electrification at predictable costs.

Progress beyond the end of the TRL scale can be quantified by a Commercial Readiness Index (CRI), of which several different scales exist (Australian Renewable Energy Agency, 2014). The scale implemented in this research is structured as shown in [Table 20](#). The lower levels of the CRI (1 to 2) scale overlap portions of the TRL scale because initial phases of commercialization

overlap with technological development. True commercialization begins at CRI 3 which falls beyond TRL 9.

Table 19. Technology Readiness Level (TRL) Definitions and Descriptions

TRL	Definition	Description
1	Basic principles observed and reported	Lowest level of technology readiness. Scientific research begins to be translated into applied research and development. Examples might include paper studies of a technology’s basic properties.
2	Technology concept and/or application formulated	Invention begins. Once basic principles are observed, practical applications can be invented. The application is speculative and there is no proof or detailed analysis to support the assumption. Examples are still limited to paper studies.
3	Analytical and experimental critical function and/or characteristic proof of concept	Active research and development are initiated. This includes analytical studies and laboratory studies to physically validate analytical predictions of separate elements of the technology. Examples include components that are not yet integrated or representative.
4	Component and/or breadboard validation in laboratory environment	Basic technological components are integrated to establish that the pieces will work together. This is relatively low fidelity compared to the eventual system. Examples include integration of ad hoc hardware in a laboratory.
5	Component and/or breadboard validation in relevant environment	Fidelity of breadboard technology increases significantly. The basic technological components are integrated with reasonably realistic supporting elements so that the technology can be tested in a simulated environment. Examples include high fidelity laboratory integration of components.
6	System/subsystem model or prototype demonstration in a relevant environment	Representative model or prototype system, which is well beyond the breadboard tested for TRL 5, is tested in a relevant environment. Represents a major step up in a technology’s demonstrated readiness. Examples include testing a prototype in a high-fidelity laboratory environment or in simulated operational environment.
7	System prototype demonstration in an operational environment	Prototype near or at planned operational system. Represents a major step up from TRL 6, requiring the demonstration of an actual system prototype in an operational environment, such as in a rail vehicle or on an actual track system.
8	Actual system completed and qualified through test and demonstration	Technology has been proven to work in its final form and under expected conditions. In almost all cases, this TRL represents the end of true system development. Examples include developmental test and evaluation of a component of subsystem in its intended system to determine if it meets design specifications.
9	Actual system proven through successful deployment	Actual application of the technology in its final form and under operational conditions, such as those encountered in operational test and evaluation. In almost all cases, this is the end of the last “Bug fixing” aspects of true system development.

Table 20. Commercial Readiness Index (CRI) Definitions and Descriptions

CRI	Definition	Description
1	Hypothetical commercial proposition	Technically ready but commercially untested and unproven. Commercial proposition driven by technology advocates with little or no evidence of verifiable technical or financial data to substantiate claims. (TRL 2 to 8)
2	Commercial trial	Small scale, first of a kind project funded by equity and/or government project support. Commercial proposition backed by evidence of verifiable data typically not in the public domain. (TRL 8 to 9)
3	Commercial scale up	Scale up driven by specific policy and emerging debt finance. Commercial proposition being driven by technology proponents and market segment participants – publicly discoverable data driving emerging interest from finance and regulatory sectors.
4	Multiple commercial applications	Multiple local applications but still subsidized. Verifiable data on technical and financial performance in the public domain driving interest from a variety of debt and equity sources but still requiring government support. Regulatory challenges being addressed in multiple jurisdictions.
5	Market competition driving widespread deployment	Competition emerging across all areas of supply chain with commoditization of key components and financial products occurring within the context of long-term policy settings.
6	“Bankable” grade asset class	Known standards and performance expectations. Market and technology risks not driving investment decisions. Proponent capability, pricing and other typical market forces driving uptake.

Table 21 shows the TRL assigned by the project team for the technologies discussed in this chapter within the North American freight rail context. All the technologies remain at CRI 1 in the context of North American freight rail electrification, except for higher-voltage OCS that achieves CRI 2 based on small scale applications to isolated industrial railway electrification and the BC Rail Tumbler Ridge project.

Table 21. TRL Rankings for Rail Electrification Technologies

Technology	TRL	Explanation
Higher-voltage OCS	9	50 kV electrification has been used in the North American freight context. Examples include the Tumbler Ridge subdivision and the Black Mesa and Lake Powell Railroad.
Lower frequency AC current in OCS	8	16.67 Hz systems have been used extensively in Germany, Sweden, and other European countries. Parts of the NEC use 25 Hz for passenger rail.
Adjustable voltage	7	Passenger trains along the NEC change voltages between 12 kV, 12.5 kV, and 25 kV. Freight rail electrifications have less experience with changing voltages, and there is little experience with switching between 25 kV and 50 kV.
Autotransformers	7	Autotransformers have been used extensively for passenger trains, but there is relatively little experience in the freight context.

Technology	TRL	Explanation
Pylon optimization	5	Modern pylon optimization techniques have not been applied in any North American freight context. The last mainline electrification project, the NEC between New Haven, CT, and Boston, MA, was built before current pylon design models were developed.
Alternatives to bridge and structure modifications	8	Various methods to reduce OCS clearances have seen wide-scale implementation internationally and on passenger/transit rail systems. For the North American freight context, some adaptation may be required to accommodate the power requirements of freight trains.
OCS construction trains	8	OCS construction trains have been in use for a long time, but not in the North American freight context, and some adaptation might be necessary for North American construction standards.
Approaches to avoid line disruptions during construction	8	Helicopters and long reach telescoping lifts have been used for heavy haul freight railway electrification projects in Australia, but may need to be adapted to specific North American freight safety regulations.
Design-build project delivery	8	BC Rail and industrial rail electrification projects pre-date design-build, but it has been applied to many passenger/transit projects.
Third rail	3	Currently no active research to address the known shortcomings of third rail for North American mainline freight rail operations.
Inductive charging	2	Experiments show promise for higher power levels in inductive systems, but no prototypes capable of the power levels required for North American freight trains have been developed.

7. Locomotive Technologies

Freight locomotive technology has changed considerably since many of the freight rail electrification studies were conducted. For heavy haul freight mainline applications, North American freight railroads have essentially standardized on a 6-axle 4,400-horsepower AC traction locomotive capable of producing 620 to 710 kN (140,000 to 160,000 pounds) of low-speed tractive effort while still being able to reach speeds of 110 kph (70 mph). To be compatible with current train operations using an equivalent number of locomotives, any electrification technology must have locomotives with similar power, tractive effort, and speed capabilities.

7.1 Current Diesel-electric Locomotives

Modern AC-motor locomotives (regardless of power rating) can generally achieve adhesion at start as high as 40 percent, meaning a 6-axle locomotive weighing 190 tonnes (420,000 pounds) can theoretically produce a starting tractive effort of up to 747 kN (168,000 pounds). Because modern North American freight locomotives are built to near the maximum allowable weight per axle (governed by the elastic strength of the steel rails), a four-axle variant can have at most two-thirds of that starting tractive effort.

As discussed in previous sections, one of the early benefits of electrification was the superior power of electric locomotives. Electrification discussions still make comparisons, for example, between North American 3.3 MW (4400 hp) 6-motor diesel-electric locomotives (547 kW or 730 hp per axle) and European high-speed electric locomotives with power ratings as high at 6.4 MW (8580 hp) but equipped with only 4-motors (1.60 MW or 2145 hp per axle). For North American freight movements, which operate at much lower speeds than their European counterparts, tractive effort is more important than power. A lower-power 6-motor diesel-electric will outperform a higher-power 4-motor electric locomotive on heavy grades when pulling maximum tonnage. This performance advantage arises because lower speed heavy grade operation puts a locomotive into the “adhesion limited” range in which available power is secondary.

Additionally, because most European electric freight locomotives are designed for compatibility with higher-speed passenger operation, their traction motors and wheelsets are geared to achieve higher speeds. High-speed gearing produces the penalty of being less capable of full-power at low-speeds.

This context is important for any discussion of mainline freight rail electrification. While past studies cited better locomotive performance as a then-unquantified benefit to electrification, the adoption of diesel-electric locomotives with AC traction motors from the 1990s through the 2010s has erased many of those potential performance advantages. North American freight rail companies currently have no plans to increase freight train speeds across their networks, meaning that the additional power availability of electric locomotives would be of limited value.

7.2 New Electric Locomotives

Most North American experience with OCS is in the context of passenger and transit systems, or a small number of isolated industrial railroads that do not interchange locomotives with other railways. Although freight operations with OCS are widespread internationally, the freight trains operated on those networks are far shorter and lighter than freight trains operated in North America (Table 22). Accordingly, international electric locomotive designs are optimized to

those freight train sizes and allowable axle loads, and are not directly transferable to mainline freight operations in the US.

Table 22. US and European Train Characteristics (Furtado, 2013)

	Typical Length (feet/m)	Upper Range of Length (feet/m)	40' Containers per Intermodal Train	Net tons per Bulk Train (typical)
US Class 1	6,500/2000	10,000/3,000	150-300	9,000-12,000
Europe	1,640/500	2,460/750	25-50	1,200-2,000

The European electric locomotive design that provides the closest performance to that required for North American mainline freight rail applications is the 6-axle IORE locomotives used by LKAB to transport iron ore in northern Sweden and Norway. These locomotives can produce 580 to 710 kN (130,000 to 160,000 pounds) of tractive effort but are limited to a maximum speed of 80 kph (50 mph). Other international 6-axle electric locomotive designs used for freight service in China, Russia, or India are not directly transferrable due to differences in axle loadings, track gage, or tractive effort performance.

Prior to the development of the IORE locomotives for Sweden, it had been several decades since the last new North American mainline freight electrification project was implemented in Canada in the mid-1980s. The GF6c electric locomotives developed for the British Columbia Railway at the time offered comparable performance to mainline freight locomotive designs of the late 1970s and early 1980s, but diesel-electric technology has advanced considerably since then to higher horsepower and tractive effort. Implementation of OCS requires the development of new electric locomotive designs meeting the horsepower and tractive effort performance requirements of current North American freight operations.

There is little practical, economic, or technical reason for US freight railroads to acquire foreign design electric freight locomotives from offshore manufactures. As mentioned above, international electric freight locomotives typically have four axles and are designed for high-horsepower ratings to achieve higher train speeds and acceleration with short, light freight trains in a predominantly passenger environment (Furtado, 2013). Conversion of one of the few existing international 6-axle electric locomotive designs, such as the IORE locomotives, to meet North American specifications requires time for development and testing. The IORE locomotives are not currently in production and were heavily customized for a limited production run of a base locomotive platform produced by Bombardier. Adapting the IORE design to North American service would require an extensive redesign to meet all FRA safety and Association of American railroads (AAR) interchange requirements (such as AAR-style couplers and a one-million-pound compressive strength standard). The locomotives would also require a new brake system and new power electronics compatible with 25 or 50 kV at 60Hz instead of the 15 kV 16.67 Hz electrification used in Sweden. The IORE locomotive trucks and AC traction motors may also need to be redesigned to accommodate more robust domestic AC traction motors designed for the greater tractive and dynamic brake forces demanded by US freight trains. Prototypes of the modified design would require extensive testing, likely on the electrified test track at the Transportation Technology Center (TTC), and a US factory would need to be converted to manufacture them at scale.

While none of these steps represent substantial technological leaps, they each require time for development and testing. As an example, the new Amtrak ACS-64 electric locomotives for passenger service on the NEC were derived from the Siemens EuroSprinter and Vectron 4-axle locomotive platform used extensively in Europe and Asia. The existing European design required extensive alteration to satisfy FRA requirements. The locomotives were ordered in 2010, with test units delivered in 2013 and the 70-unit fleet entering revenue service from 2014 to 2016. A similar timeline might be required to develop or adapt an international 6-axle electric freight design for use in North America.

7.2.1 Conversion of Diesel-electric Locomotives to Straight Electric

As opposed to developing a new electric freight locomotive design, or adapting an existing international 6-axle electric locomotive design to North America, a more efficient short-term option may be to convert existing diesel-electric locomotives to straight electric operations.

Many 6-axle AC traction freight locomotives built in the late 1990s are due for rebuilding, and have a “DC bus” with power inverters that help facilitate conversion to straight electric operation (this would be a more involved task for an older DC traction locomotive). Instead of rebuilding with a diesel prime mover, the diesel engine and alternator could be removed and replaced with an appropriate transformer, pantograph, batteries, and the required switchgear and power electronics to create an electric locomotive with some battery capability to motor through gaps in the OCS or provide “last-mile” propulsion into terminals or on non-electrified branches (Figure 18). The basic locomotive platform, 6-axle trucks, traction motors, and cab could all be re-used, although most recent rebuilds involve installing upgraded cabs and replacing traction motors (Table 23).

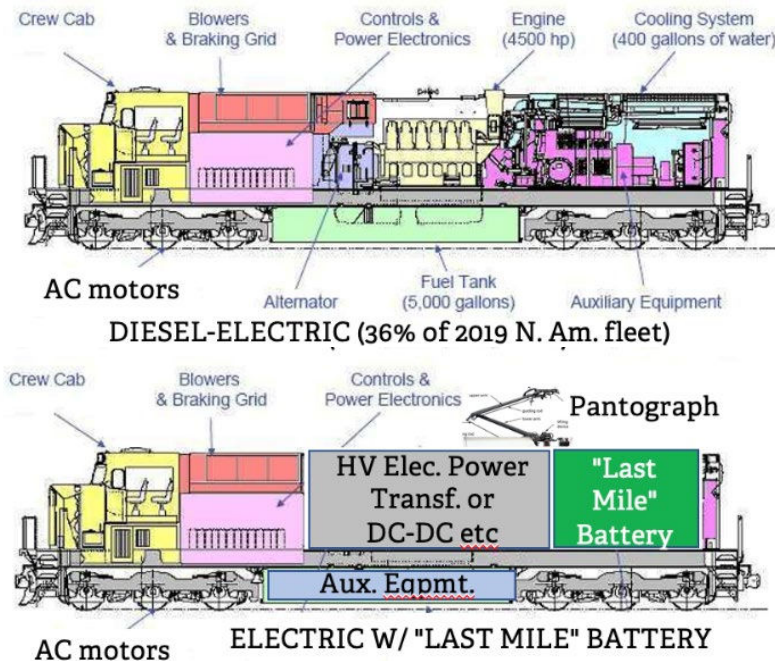

Figure 18. Conceptual Conversion of Existing AC Traction Diesel-Electric Locomotive to Electric Operation Via OCS

Table 23. Components of Existing Diesel-Electric and Converted Electric Locomotive

Locomotive Type	Platform	Transmission	Trucks	Operating Cab	Car Body	Propulsion Hardware
Existing Diesel-Electric	Existing Diesel	Existing AC-DC-AC	Existing AC Traction	Existing	Existing	Diesel Engine, Alternator, Cooling, etc. <i>(to be removed)</i>
Converted Electric	Modified	OCS-DC-AC Battery-DC-AC	Existing AC Traction	Existing	Modified	Pantograph, Transformer, Auxiliary Equipment

An existing 3.3 MW (4,300-4,400 hp) AC traction diesel-electric freight locomotive platform can be converted into an electric locomotive with more than 5,000 traction horsepower. Both Wabtec/GE and Progress Rail/EMD 6-axle AC traction freight locomotives are designed to operate at full traction power with up to two AC motors “cut out” (i.e., not producing power) and the full traction power directed to the remaining four AC motors. The excess design capacity of the AC traction motors could be fully utilized by a higher-power electric locomotive configuration if higher-speed freight operations are desired in the future.

All the required components for a diesel-to-electric conversion are proven technology, but time is required to develop an actual design, construct a prototype, and conduct testing on an electrified line segment or at the TTC. With data from prototype testing, the economics of the diesel-to-electric conversion process could be compared to other options (such as new straight electrics or the dual-mode conversion options discussed in subsequent sections) to determine its viability as a modern option for electrification. If a favorable determination is made, manufacturers could then begin production conversions of existing AC traction diesel-electric locomotives at scale.

A final consideration regarding a diesel-to-electric conversion is that US (and Canadian) freight railroads have extensive experience operating, and especially maintaining, AC traction motors, trucks, and locomotives in general based on domestic Wabtec/GE and Progress Rail/EMD designs. Migrating European designs and concepts to North American railroads will involve significant demands for new techniques, procedures, skills, tooling, and especially replacement parts and systems. The six Class 1 freight railroads in the US (two of which are the major freight railroads in Canada) are all fully “skilled and stocked” in the inspection, maintenance, repair, and overhaul of US-design diesel-electric freight locomotives. To the extent that a diesel-to-electric conversion will use existing locomotive components, this approach will make better use of the existing railroad industry workforce and equipment, with reduced need for new skills and re-training. The primary area for training and skills development is high-voltage safety and diagnosis of electrical systems operating up to 50 kV AC. By converting existing diesel-electric or manufacturing new electric locomotives using common design features, the transition burden on freight railroads can be significantly reduced.

While converting existing diesel-electric locomotives to straight electric operations in the short term may reduce the cost and timeline of acquiring new freight locomotives compatible with mainline electrification, they do not address the problem of needing large portions of a mainline corridor or network to be electrified before straight electric propulsion is feasible from a train operations perspective. Thus, while diesel-to-electric conversions may reduce overall costs, they

are unlikely to move benefits forward to provide an earlier ROI. As discussed in later sections, the dual-mode conversion of existing locomotive platforms is likely to be a faster way to make use of catenary as it is constructed, and allow time for the development and commercialization of new North American freight electric locomotive designs.

7.3 Battery-electric Locomotives

Electric propulsion using onboard batteries has eliminated the need for OCS on some of the newest tram, streetcar, and light rail transit systems. Such an approach is feasible for these systems because the vehicles are light and the trains short, the vehicles make frequent station stops where battery charging can take place en route, and the vehicles do not travel far from their operations base where charging infrastructure recharges batteries each night while passenger service is suspended.

Extending the concept of battery propulsion to the scale required to be a substitute for OCS on mainline heavy haul freight operations is a more difficult challenge. Pure battery-electric locomotives (BELs) have seen limited mainline testing, and thus their long-term range and battery-life performance under various climate, topography and operating conditions is uncertain. US freight railroads have begun to implement BELs in yard service where they can remain close to their charging infrastructure and power demands are a better fit for available onboard battery storage.

BELs can be an alternative to conventional electric locomotives under certain circumstances, particularly related to operating parameters (train weights and speeds), topography (grades), distance between major terminals, etc. All recent BELs delivered or in production use variations of basic lithium-ion battery design; the most common chemistries are lithium-nickel-manganese-cobalt oxide (NMC) and lithium-iron-phosphate (LFP). The energy density of these battery chemistries is a key limitation on the ability of a BEL to replace diesel-electric or conventional electric propulsion.

An important caveat on BEL capability is that locomotive manufacturers typically label their BELs with the “nameplate” rating for energy storage, meaning the energy stored at 100 percent state of charge (SOC). The nameplate rating is not the same as the “usable” energy rating for propulsion, which accounts for not depleting a battery to zero energy to avoid damage to the batteries by excessive draw down of charge. The common approach of BEL builders today is to assign a usable rating equivalent to 85 percent the nameplate rating, corresponding to a usable battery range from 95 to 10 percent SOC. Because the full range of battery SOC is not actually available for use by the locomotive, 1.00 MWh of nameplate energy storage rating only corresponds to a usable propulsion energy rating of 0.85 MWh.

Given the constraints of battery chemistry, energy density, and usable SOC, the energy storage of a BEL cannot match that of a diesel-electric locomotive, or the unlimited potential of straight electrification with OCS for mainline freight applications over long distances (Iden M. , Battery Storage of Propulsion Energy for Locomotives, 2014). A contemporary 3.3 MW (4,400 hp) diesel-electric locomotive with a 5,000 US gallon fuel tank has onboard usable energy (net of overall losses assumed at 40 percent efficiency) of 75.6 MWh, or enough onboard energy to continuously operate at full power (throttle notch 8) for approximately 23 hours. BELs with over 14 MWh of battery storage (12.3 MWh usable energy) have been proposed for service on dedicated iron ore railways in Australia, but these locomotives require 8 axles to distribute the

weight of the locomotive over the robust heavy haul track structure. Current North American freight locomotives have six axles and thus can only support BEL storage capacities in the range of 8 to 9 MWh (6.8 to 7.65 MWh usable energy). This capacity alone is not sufficient to power freight operations over many long-distance routes, even when energy is recaptured and stored in the batteries during braking on downhill segments.

7.3.1 Battery Tenders

Various options have been proposed to extend the range of BELs, such as en route charging from short segments of OCS, additional battery storage on tenders coupled to each BEL, or modular “battery packs” that could be swapped on and off locomotives at intermediate stops between origin and destination (Iden, 2021). However, these proposals remain conceptual since none of these technologies have been demonstrated for freight operations, and further research and development is needed prior to commercialization. Of these options, battery tenders are discussed further because they have the potential to be used with BELs and other suitably equipped electric and diesel-electric locomotives capable of receiving electric power across the coupler into the DC bus of their AC traction systems.

A BEL is defined by AAR in Standard S-5019 (last revised 2019) from the AAR Manual of Standards & Recommended Practices (MSRP) Section M as follows:

“A locomotive powered exclusively by onboard batteries, capacitors, or similar electrical energy storage devices.”

AAR Standard S-5019 also defines a battery tender as follows:

“A type of tender that stores and provides energy in the form of electricity. The battery(ies) may be recharged from an off-board electric energy source or from the locomotive to which the battery tender is coupled and connected, by regenerating or converting the locomotive’s dynamic braking energy and transferring it across the couplers to the tender’s battery(ies), and properly configuring, conditioning, and controlling that electric energy to place it into the storage battery(ies).”

A battery tender (BT) does not have traction motors; if it does have traction motors, it becomes a BEL. Further, a tender is not a freight car, but is a “locomotive appurtenance,” as defined by the AAR in Standard S-5019:

“A rail vehicle that has the purpose of containing/storing energy (fuel or electricity) and of providing that energy to one or more coupled locomotive(s). The tender as a whole is considered to be a locomotive appurtenance, with the exception of those items that are not required to be in proper condition for safe operation (e.g., cabinet lights).”

As an example, a 7.0 MWh (nameplate) BT coupled to and connected with a 7.0 MWh (nameplate) BEL could double the available energy and theoretically double the operating range of the 7.0 MWh BEL between recharging events. This equates to an increase from 1.8 hours to 3.6 hours between charging events for the same full power (throttle notch 8) scenario used to estimate the operating time range (23 hours) of a conventional diesel-electric locomotive described above.

While doubling the operating range by doubling battery energy storage may be desirable, a corresponding downside is the need to recharge not just a 7.00 MWh (nameplate) BEL but 14.00 MWh (nameplate) of combined BEL and BT storage at some point en route. Recharging this

combination within the same time it takes to charge a BEL alone will require twice the charging capability and double the peak load of the charging station on the commercial power grid. Additional battery charging considerations are discussed in the next section.

An additional factor to consider when implementing the BEL+BT combination is the dead weight of the BT when it is depleted (i.e., reduced to 10 percent SOC) and can no longer contribute tractive effort to propel the train. When depleted, a 216-ton 6-axle BT (without traction motors) creates the equivalent traction effort demand of 1.5 loaded 143-ton freight cars or 9.4 empty freight cars.

7.3.2 Battery Charging

Another compounding factor that may limit BEL capability is the viability of high-power charging to support economical locomotive utilization. Higher-power stationary charging requires propulsion batteries that can accept high rates of energy transfer. The faster a battery is charged, or the greater the amount of charge energy, the greater the demand on the connected grid, and the greater the demand on the locomotive battery management system to safely protect the battery during charging or discharging

Research is still ongoing to develop 1 MW and 2 MW stationary chargers that could recharge an 8 MWh BEL in eight or four hours, respectively, while the BEL is parked at a servicing facility. For comparison, diesel-electric technology has matured by incorporating very large fuel tanks and high-volume stationary refueling nozzles capable of delivering 300 US gallons per minute (GPM), translating to refilling a 5000 USG tank in only 17 minutes. The comparatively long BEL recharging periods will limit the amount of time BELs are available to haul freight, increasing the required locomotive fleet size and investment relative to other locomotive technologies that do not require such long, unproductive servicing times.

While stationary charging of BELs is less complex than en route charging in motion, and does not require construction of OCS infrastructure, it does require the BEL to return to fixed charger locations/terminals that represent investments in infrastructure. The stationary chargers also require adequate connections to the local electric utility grid. Because a large locomotive terminal with numerous BEL chargers may create a concentrated load that exceeds the demands of a typical OCS section under traditional electrification, the substations and utility connections to support large-scale BEL charging may need to be of a higher capacity, and greater expense, than the substations and grid connections required for traditional OCS electrification.

An alternative approach is to charge a BEL from energized OCS while it is in motion hauling a moving freight train. However, when the BEL stops moving (e.g., to pull into a passing siding for a meet with an opposing train), large amounts of charging energy cannot be transferred from the OCS to the BEL because OCS and pantographs are designed for “sliding contact” even at relatively high currents. If the pantograph becomes stationary, localized, destructive overheating of the pantograph contact bar and the OCS contact wire will occur, damaging both systems.

If continuous OCS is available, BEL charging can occur anywhere under the energized OCS (provided the BEL is moving), offering greater flexibility in when and where the BEL battery is recharged. If partial OCS is available, BEL charging must be properly managed to match recharging events with availability of energized OCS, otherwise the BEL is at risk of depleting its usable energy and stalling.

7.3.3 Regenerative Dynamic Braking

The final option for charging BELs and BTs is regenerative dynamic braking. Dynamic braking on locomotives is accomplished by temporarily converting the traction motors (either DC or AC) from “motors” to “generators” through the locomotive control system, with energy generated by the traction motors in dynamic braking directed to dynamic brake resistor grids on the locomotive roof. At the resistor grids, the electrical energy from the traction motors is converted into heat (i.e., thermal energy) and dissipated to the atmosphere. On a diesel-electric locomotive, dynamic brake energy is not regenerated (i.e., captured and re-used elsewhere) but simply dissipated as heat. Future locomotives with propulsion batteries (e.g., BELs or various hybrid combinations with onboard batteries) can be partially recharged with dynamic braking energy, which is called “regenerative dynamic braking.”

The technical effectiveness of dynamic braking has improved significantly since the mid-1980s with the introduction of DC dynamic brakes with greater maximum retarding force (typically at speeds of 10-20 miles per hour) and the introduction of AC dynamic brakes in 1992 allowing maximum dynamic-braking force (at speeds of almost zero to 20 mph). However, dynamic brakes are regarded as a secondary braking system that supplements the primary braking system that consists of the air brakes that control friction brake shoes on the railcar and locomotive wheels. In general, when handling a train, air brakes are used to bring a train to a stop or offset the force of gravity on a sustained downhill grade, while dynamic brakes are used in conjunction with the air brakes to modulate train speed over more subtle changes in terrain. Although railroads have increasingly encouraged the use of dynamic brakes to save fuel, the primary air (i.e., friction) brake system is still used extensively. Thus, not all train braking forces are available to be recaptured and charge onboard batteries through regenerative dynamic braking.

A further limitation is that railroads have created various restrictions on the use of regenerative dynamic braking to reduce the risk of train handling and make-up derailments caused by excessive locomotive dynamic braking force applied to the front of various types of trains. The presence of three or more locomotives in full dynamic brake at the front of the train can create excessive compressive “buff” in-train forces that can cause the leading freight car to derail due to a wheel-climb or rail-rollover incident.

To avoid the risk of such accidents, good train handling practices limit maximum dynamic braking force at the front of the train to approximately 250,000 pounds. The most effective way of limiting dynamic brake forces is to “cut-out” (i.e., make temporarily inoperable) the dynamic brakes on excess braking units. Individual railroads have specific operating and train handling rules to accomplish this. The implication for regenerative dynamic braking is that “universal anytime” recharging of batteries from dynamic brakes cannot be assumed. For an example consist of four BELs at the front of a train, the dynamic brakes will usually be operable only on the first and second locomotive units, and possibly (sometimes partially) on the third unit, but not on the fourth unit. The third and fourth units will thus not have any access to regenerative dynamic braking energy to restore their battery SOC, and will have less range than the leading two units on a given route. It is a misconception that locomotives with propulsion batteries can and always will achieve regenerative dynamic brake charging energy when in operation.

7.3.4 Conversion of Diesel-electric Locomotives to Battery Electric

As opposed to developing a new battery-electric freight locomotive design, a more efficient option may be to convert existing diesel-electric locomotives to BELs. In this scenario, the diesel engine and alternator of an existing 6-axle AC traction locomotive slated for rebuilding could be removed and replaced with propulsion batteries and the required switchgear and power electronics to create a BEL (Figure 19). Reusing the basic locomotive platform, 6-axle trucks, traction motors, and cab could substantially reduce the cost of BELs, and create a flexible platform that allows for batteries to be efficiently replaced as they degrade or upgraded to new chemistries as battery technology advances in the future.

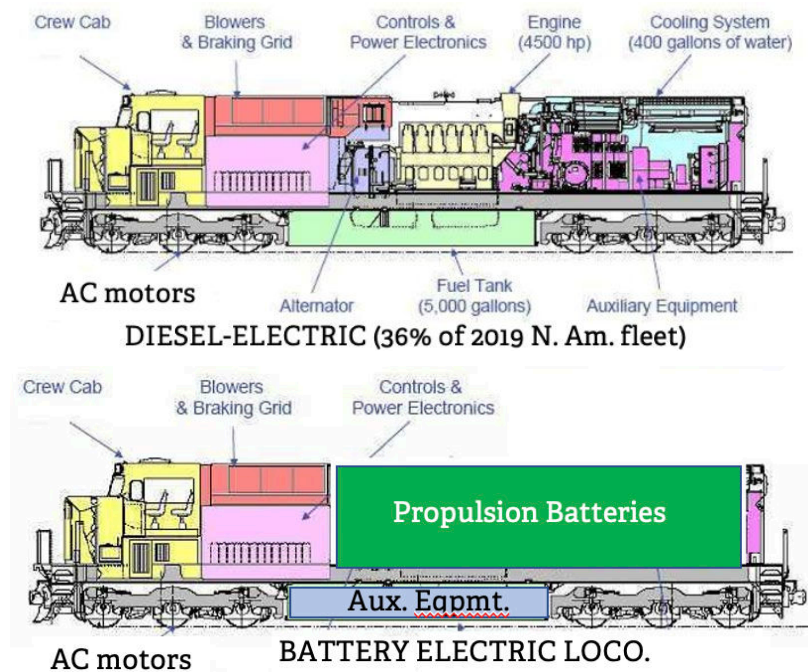

Figure 19. Conceptual Conversion of Existing AC Traction Diesel-Electric Locomotive to BEL

The same approach could be used to develop a hydrogen fuel cell locomotive, with a large portion of the propulsion batteries illustrated in Figure 19 replaced by hydrogen fuel cells. Due to a lack of onboard storage space, hydrogen would need to be supplied across the coupler from a hydrogen fuel tender coupled to the locomotive. A more thorough examination of hydrogen-powered locomotives is outside the scope of this study.

7.4 Dual-mode Locomotives

This section explores the technology of dual-mode locomotives (DML) capable of operating under historic diesel-electric propulsion using chemical energy (i.e., diesel fuel) as well as electric propulsion using electrical energy from an energized OCS. As will be demonstrated, DMLs have distinct advantages in facilitating future electrifications, as compared to the conventional electric locomotives traditionally associated with railroad electrifications. With the foundation for various locomotives established in the preceding sections of this chapter, this section investigates dual-mode freight locomotives by covering various topics including: their definition and importance; a previous study of a dual-mode conversion of a diesel-electric

locomotive; current DML designs used for passenger service; and conceptual conversion of an AC traction locomotive into a DML. The remainder of this section discusses the effect DMLs could have on the overall cost-benefit performance of electrification projects, a comparative overview of locomotive technologies, and the remaining unknowns for progressive electrification with DMLs. Finally, this section concludes with a recommendation for an updated DML conversion project for further investigation of these unknowns.

7.4.1 DML Definition

The AAR defines a DML in Standard S-5019 (last revised in 2019) of its MSRP as follows (Association of American Railroads, 2024):

“A locomotive that is propelled using power generated by onboard diesel engine(s) or by power obtained from overhead electrified catenary wire or ground-level third rail. Otherwise and frequently also known as an “electro-diesel” locomotive. When propelled with power from the onboard diesel engine(s), it functions as a diesel-electric locomotive. When propelled with power from the overhead catenary or third rail, it functions as an electric locomotive. Unless otherwise specified, a dual-mode (or “electro-diesel”) locomotive shall have two separate performance characteristics, including traction horsepower and tractive and dynamic braking efforts, based on the specific propulsion mode being used.”

This definition of DMLs does not include locomotives using batteries for motive power. Hybrid locomotives using both batteries and overhead catenary will be discussed in greater detail in the next section. While AAR’s definition includes locomotives operating with electricity derived from a third rail, this is not practical for freight line-haul locomotives for the reasons discussed in the previous section.

7.4.2 Importance of Dual-mode Electro-diesels for Future Freight Electrification

Dual-mode locomotives allow for trains to transition from one source of motive power to another without costly delays at locomotive change stations. This adds flexibility to railroad operations, and can be particularly important for the early years of an electrification project. [Figure 20](#) illustrates how DMLs would facilitate operation of both dieselized and electrified territories without the traditional train delays and terminal infrastructure needed to support power changes. A power change is required when an inbound train arrives at a terminal with diesel-electric locomotives, and the same train outbound train is expected to operate with electric locomotives. The same situation and resultant issues will exist in the opposite direction (i.e., inbound with electric and outbound with diesel-electric locomotives).

As [Figure 20](#) shows, the dual-mode operation also allows for gaps within the OCS territory, either along segments that are too costly to electrify, or during the duration of OCS construction. An alternative workaround would be to operate both diesel-electric and electric locomotives across all territories, which would waste energy by dragging the deadweight of the locomotives not being used, and it would be a highly inefficient use of expensive locomotive assets.

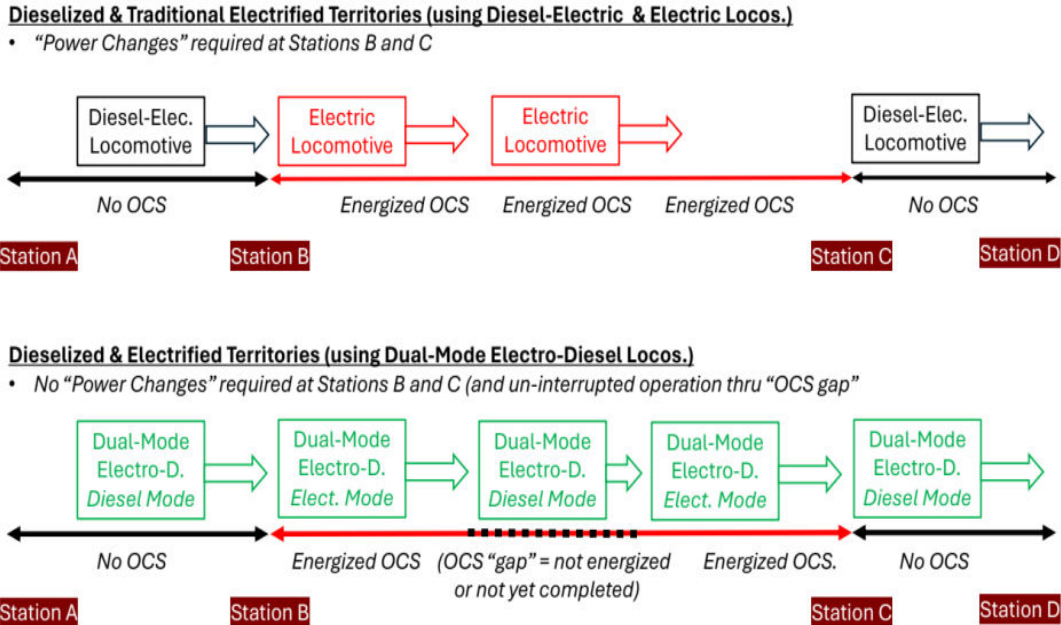
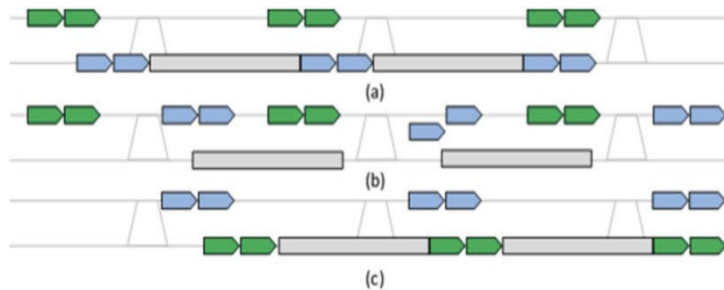

Figure 20. Conventional Electrification (top) Versus Dual-mode Operations (bottom)

A report sponsored by the California Air Resource Board in 2016 (Rail Transportation and Engineering Center, 2016) investigated operational issues, including delays to trains and additional terminal infrastructure needed for power changes at intermediate terminals. The report included extensive analyses of train delays based on documented test operations of a train on a Class 1 railroad in simulated diesel-to-electric or electric-to-diesel power change situations, as well as the physical infrastructure additions needed to replace locomotives safely and economically within freight trains.

For example, [Figure 21](#) below shows the physical movements of electric (green pentagons) and diesel-electric (blue pentagons) locomotives in the process of being swapped at a power change location equipped with two tracks. The train with electric locomotives arrives (a), electric locomotives are removed (b) and replacement diesel-electric locomotives are moved into and onto the train (c) (Rail Transportation and Engineering Center, 2016).



(Green pentagons represent electric locomotives, blue pentagons represent diesel-electric locomotives, and gray rectangles represent the rest of the train's consist.)

Figure 21. Exchange Point Operations on Paired "Herringbone" Exchange Tracks

Such power change activities would be impractical at locations with high volumes of freight trains passing through daily (including important freight rail terminals, such as El Paso, Texas, Belen, New Mexico, or North Platte, Nebraska). The UIUC report examined the hypothetical additional yard trackage needed to facilitate locomotive exchanges in a high-volume terminal, illustrated in Figure 22 below (Rail Transportation and Engineering Center, 2016).

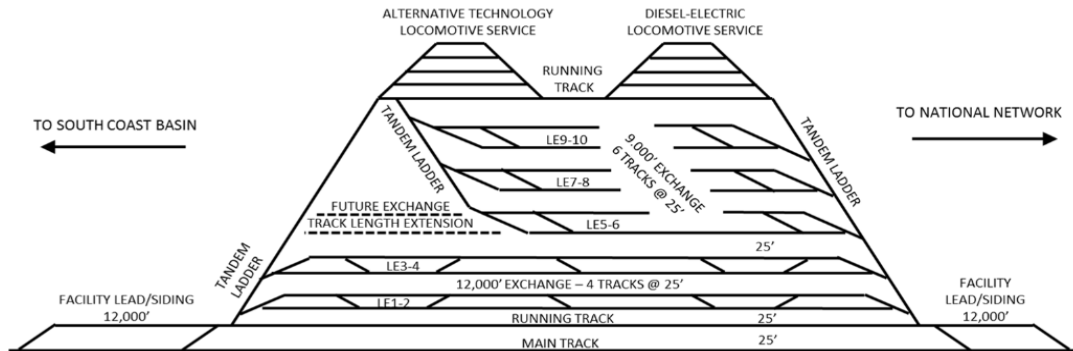

Figure 22. Locomotive Exchange Point Conceptual Design Schematic

Freight trains longer than 12,000 feet (3.65 km) operated with distributed power (DP) technology are becoming increasingly common in the US (Rail Transportation and Engineering Center, 2016) (Dick, Zhao, Liu, & Kirkpatrick, 2021). DP places one or more locomotive units on the head-end (i.e., front) of a train, remotely controlled DP units at various locations mid-train, and remotely controlled DP units on the rear-end of the train. In a power change situation, all those locomotive groups would have to require replacement (diesel-electric replaced by electric, or electric replaced by diesel-electric). Trains operating under DP require more work for power changes than trains with only one locomotive group. Figure 23 below shows a simplified example of a freight train with four DP consists in addition to the head-end locomotives.

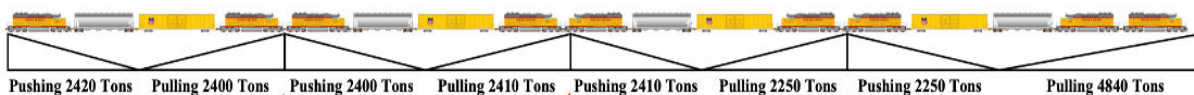

Figure 23. Example of Distributed Power Operations for a Train is Moving from Left to Right

Without DMLs, building power change facilities to effectively accommodate all the possible DP configurations of future trains would be impractical.

7.4.3 Dual-mode Conversion of a DC Traction Diesel-Electric Locomotive

FRA issued a report in February 1981 detailing the conversion of an SD40-2 6-axle DC traction diesel-electric freight locomotive to an SD40-2 DML (Cook & Lawson, 1981). While the SD40-2 is no longer in production, many of the findings from the report are still relevant for the discussion of dual-mode freight locomotives today. The report studied conversions that would be compatible with either 25 kV or 50 kV electrification. Importantly, the report found that “the space requirements for the electric components are compatible with installation on existing locomotive platforms without interfering with the diesel power equipment” (Cook & Lawson, 1981). The researchers calculated a conversion cost of \$414,000 in 1981 dollars or roughly \$1.4 million in current dollars. Researchers noted at the time that a dual-mode conversion “will make

possible an initial electrification project that will result in a ROI that is superior to conventional electrification for a fraction of the initial cost” (Cook & Lawson, 1981).

High-level development of an SD40-2 DML was completed, but in-service demonstration and deployment never occurred. The rationale for the project research was as follows:

- Find a method to reduce the large initial investment for railroad electrification while maintaining (or improving) ROI.
- Retain the operational flexibility of diesel-electric locomotives.
- Minimize the introduction of (risky and expensive) new technology associated with future electrifications.

7.4.3.1 1981 Report Overview

The project contractor selected the GM-EMD SD40-2 as the appropriate US freight locomotive model because it represented 21 percent of the US line-haul diesel-electric freight locomotive population in 1980-1981 and was commonly operated by most Class 1 railroads. The SD40-2 DML would have two sources of propulsion energy for its six DC traction motors:

- The diesel engine-traction alternator would convert chemical energy (i.e., diesel fuel) into mechanical and electrical energy; alternator (AR10) AC power would be rectified into DC power supplied to the six DC traction motors in the conventional diesel-electric mode.
- When operating in electric mode, the onboard pantograph would contact an energized OCS wire (25 kV or 50 kV), and high voltage AC would be reduced appropriately and converted into controlled DC power to supply the traction motors (Figure 24)

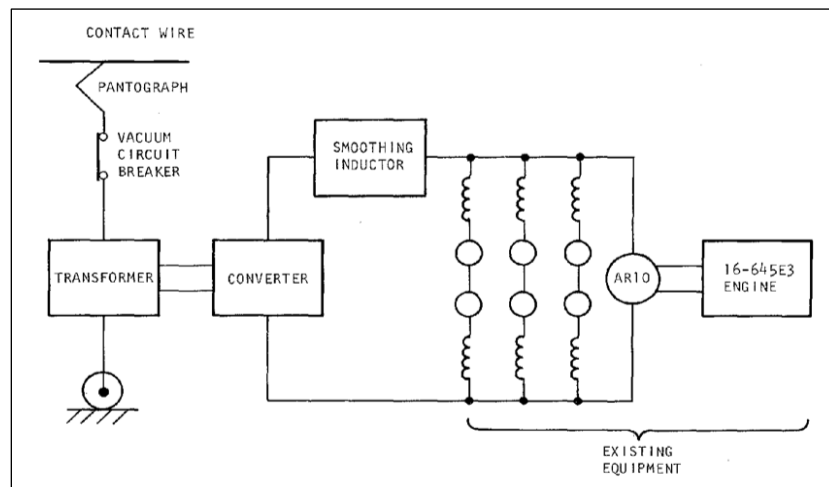

Figure 24. Simplified DML System Diagram (Cook & Lawson, 1981)

7.4.3.2 Conversion Process

The report detailed the modifications necessary to convert an SD40-2 to an SD40-2 DML. Figure 25 shows the equipment layout for the SD40-2 DML intended for electrification at 50 kV. This is a colorized reproduction of Figure 3 from the 1981 FRA report. Figure 26, also taken from the 1981 FRA report, shows the layout of an as-built SD40-2. The primary method for

accommodating the electrical hardware was to move the locomotive's cabin forward. The SD40-2 used a 68' 10" underframe that was common to the SD45-2 locomotive which had a larger diesel engine. The diesel engine and the traction alternator would remain in the same space, and the extra room between them and the shifted cabin would be filled with the stepdown transformer and a single pantograph along the roof. This transformer would be built to accept either 25 kV or 50 kV 60 Hz AC electricity. The main AC-to-DC converter assembly would be installed at the rear-end of the locomotive, along with an inductor assembly. To keep the SD40-2 DML at 398,000 lb gross weight (generally the acceptable maximum weight in that era for a 6-axle freight locomotive), the diesel fuel tank would be reduced from 4,000 gallons (about 15,000 liters) to 3,000 gallons (about 11,000 liters) – a 25 percent reduction.

7.4.3.3 SD40-2 DML Estimated Performance

In performance, the SD40-2 DML would retain the 3,000 hp rating of the SD40-2 in diesel-electric mode, while it would achieve a 4,500 hp rating when in electric mode. This was possible because the GM-EMD D77 traction motors were each rated at 750 traction hp (559 kW) when installed under a 3000 hp 4-motor GP40-2 locomotive, allowing the SD40-2 DML to take advantage of the higher available power from the OCS.

Figure 27 shows the estimated speed versus tractive effort performance of the SD40-2 DML in diesel-electric and electric modes, compared to a modern 4,400 hp 6-motor AC freight locomotive. The higher-speed (greater than 25 mph) performance of the SD40-2 DML in electric mode would essentially replicate the 4,400 hp 6-motor AC diesel-electric, but in diesel-electric mode the SD40-2 DML, as expected, has about 32 percent less tractive effort. The low-speed performance (below about 12 mph) is similarly limited by the adhesion characteristics of DC motors compared to AC motors.

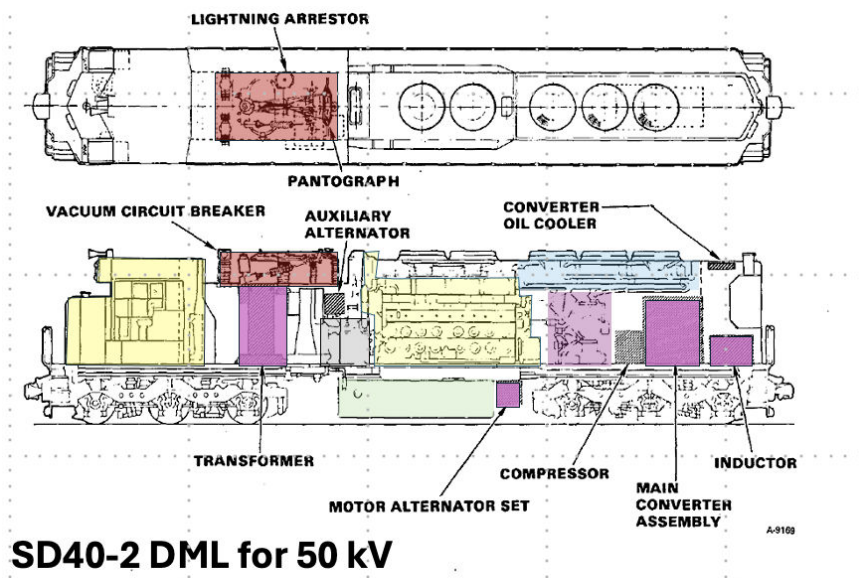

(Figure 3 adapted from the 1981 FRA report. The 25 kV DML layout is similar)

Figure 25. Equipment Layout for the 50 kV SD40-2 DML

SD40-2 as-built

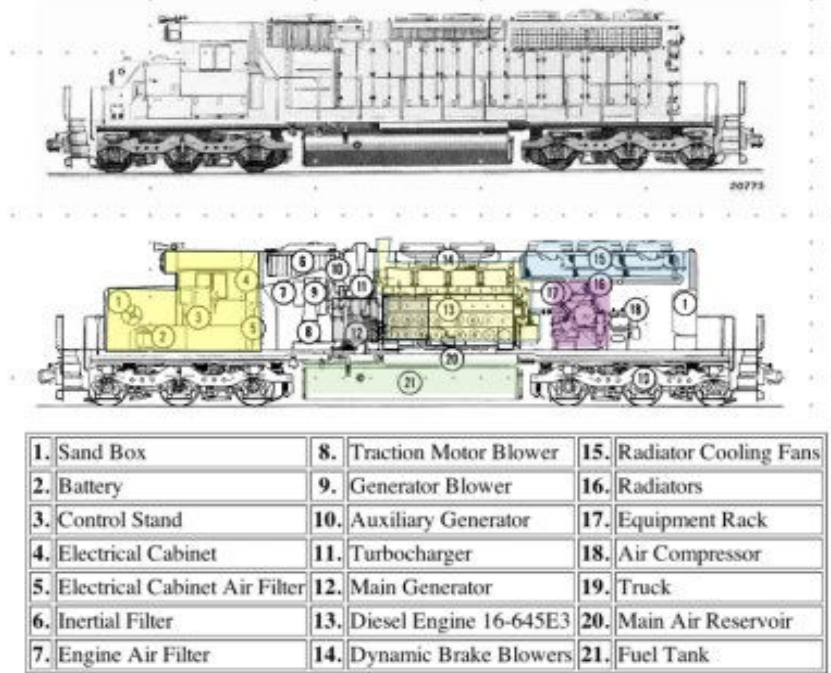

Figure 26. Components of the SD40-2 As-built

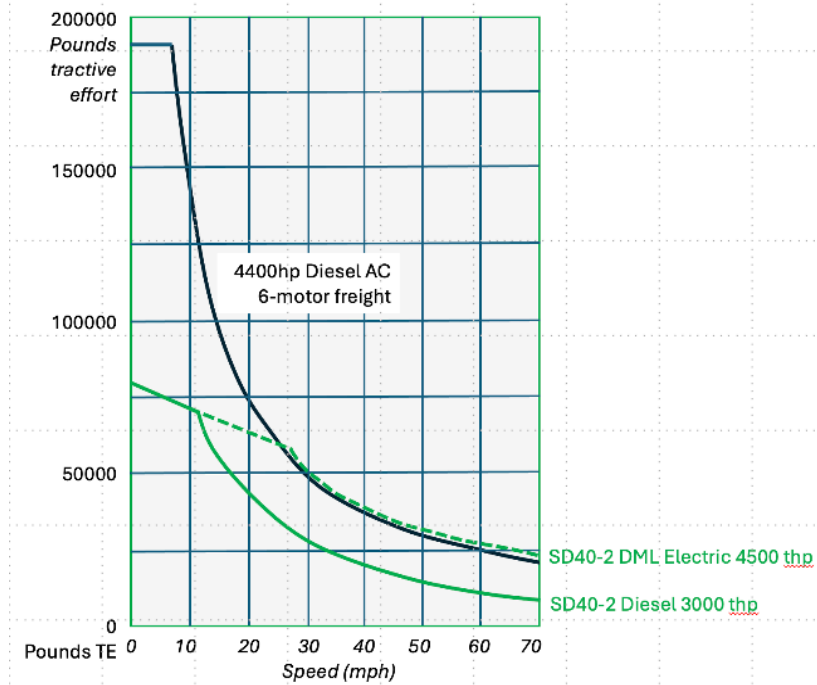

Figure 27. Comparison of the Estimated Performance of the SD40-2 DML with a Modern 4,400 hp Diesel-electric Locomotive with AC Traction Motors

7.4.3.4 Project Outreach and Proposed Testing Timeframe

As part of their research, the contractor had discussions on October 16, 1980, with FRA and various US Class 1 railroads (AT&SF, BN, C&NW, Conrail, L&N, Milwaukee Road, Missabe, MoPac, SCL, Southern, SP, and UP).

The SD40-2 DML was the fourth element in FRA's energy program of the time. The first three elements were a railroad energy audit, alternative fuels, and fuel efficient train operations, and the program also supported a parallel but independent WESS research project considering stationary flywheel generators to capture locomotive dynamic braking energy via OCS and redirect the stored energy back into the OCS for propulsion (WESS is discussed in more detail in [Section 2.5.2](#)).

The SD40-2 DML concept was considered by FRA for "stand alone" operation on ruling grades, as a contributor to future incremental (i.e., progressive) electrifications, and to optimize future locomotive fleet mixes. The report included a "Possible Time Scenario," shown in [Figure 28](#), that included construction of at least one SD40-2 DML prototype to be tested at the TTC near Pueblo, Colorado, on the electrified Railway Test Track, and used in a potential railway electrification project starting in the mid-1980s. The seven-year timeline of this program is important to consider when evaluating modern options for freight railway electrification that involve the development and testing of new locomotive designs.

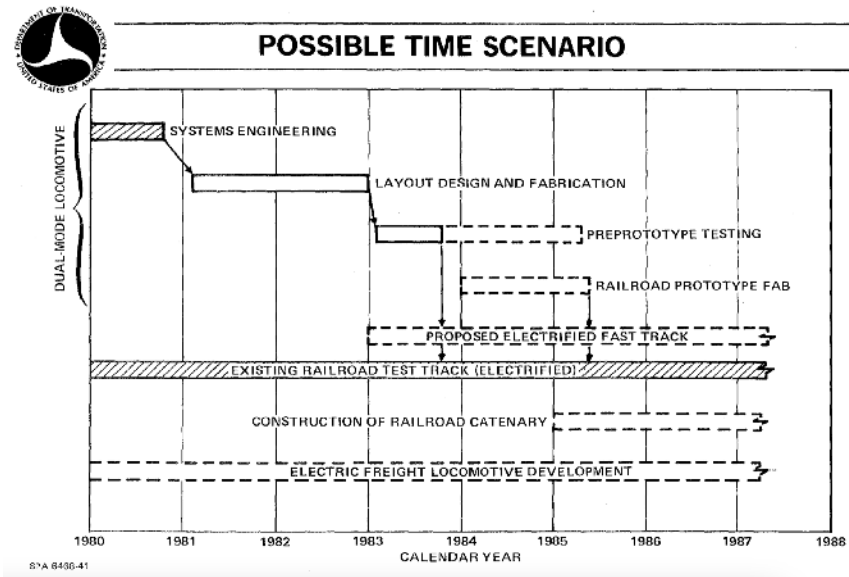

Figure 28. Timeline for Prototyping of the SD40-2 DML in the 1981 FRA Dual-mode Locomotive Research Project

7.4.4 Alstom/Bombardier ALP45DP Dual-mode Commuter Locomotive

While the SD40-2 DML was never built, other DMLs have seen active use. The Alstom/Bombardier ALP45DP is a 4-axle, 4-AC motor DML designed for commuter rail operation. While it is not suitable for heavy rail freight operation, examining it helps to highlight the challenges of fitting both diesel-electric and electric propulsion systems within a single locomotive chassis.

The ALP45DP is a derivative of the non-dual-mode diesel-electric NJ Transit (NJT) ALP46, which itself is a derivative of the TRAXX line of modular diesel-and-electric locomotives in Germany. The ALP45DP is designed for high acceleration of long (i.e., 12 car) commuter trains when departing stations. By contrast, contemporary US AC diesel-electric freight locomotives are designed for maximizing the tractive effort available at lower speeds, handling high tonnage freight trains, and long-distance fuel capacity. The ALP45DP and the typical 4,400 hp 6-AC motor freight diesel-electric locomotive have nearly identical lengths, nominally 73 feet over couplers. The ALP45DP, however, has two smaller, lighter weight, high-speed (1800 rpm) diesel engines while the 4,400 hp freight locomotive has a single, larger, medium-speed diesel engine (widely used throughout the US railroad industry). Minimizing equipment space and weight was critical in the design of the ALP45DP.

7.4.4.1 Design Characteristics

Figure 29 shows the physical arrangements of an ALP45DP and an ES44AH (indicative of a typical 4,400 hp diesel-electric freight locomotive). The two locomotives are very similar in length and these diagrams show them at scale with each other. The diagrams use similar color coding for similar components. In diesel-electric mode, the ALP45DP uses two smaller, relatively lightweight diesel engines, each rated at 1,800 hp (1,350 kW) for a rated power of 3,600 hp (2,700 kW). In electric-only mode it achieves a continuous power of 5,360 hp (4,000 kW), and can utilize OCS overload capacity to reach 5,900 hp (4,400 kW) in short bursts, such as when accelerating away from stations. Approximately 800 hp (600 kW) can be diverted from the diesel-electric mode for head-end power (HEP).

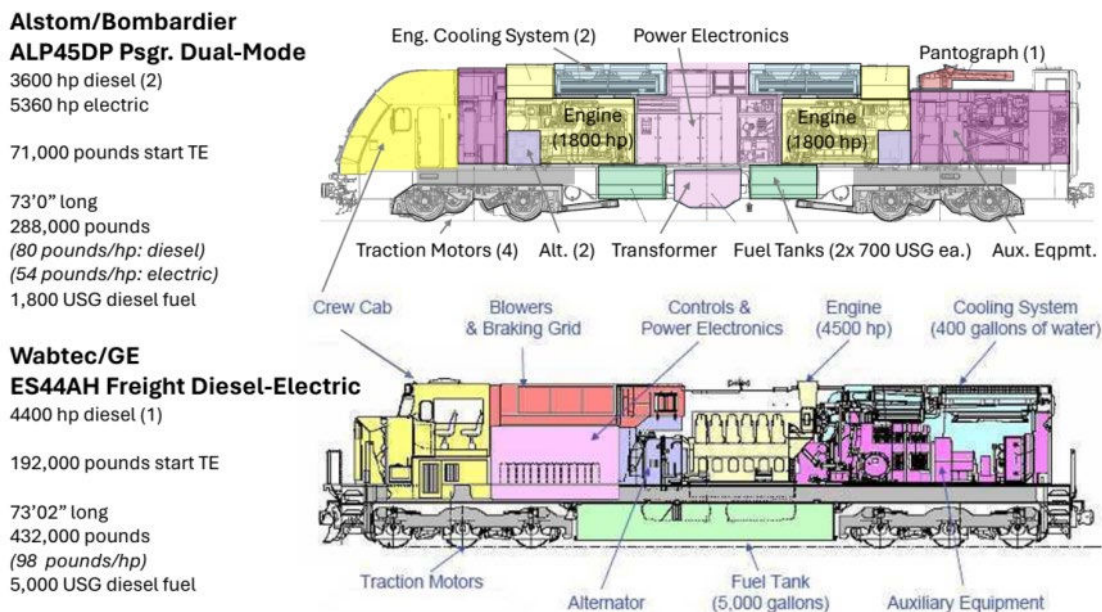

Figure 29. Comparison of the Internal Equipment for an ALP45DP and an ES44AH

The design of the ALP45DP had the following objectives:

- High power-to-weight ratio to facilitate higher-speed operation and better acceleration of trains from station stops
- Minimize weight to achieve better energy efficiency

- Dual-mode capability to operate with or without energized OCS

To achieve these objectives, the ALP45DP sacrifices diesel-electric mode power and range (due to two smaller higher-speed engines and a smaller fuel tank) and overall maximum tractive effort. The locomotive’s maximum starting tractive effort is 71,000 lb (316 kN) and its maximum continuous tractive effort is 59,000 lb (262 kN) – it would take nearly three ALP45DPs to match the tractive effort of a single typical line-haul freight locomotive. Figure 30 shows the speed versus tractive effort of the ALP45DP compared to a 4400 hp diesel-electric AC 6-motor freight locomotive.

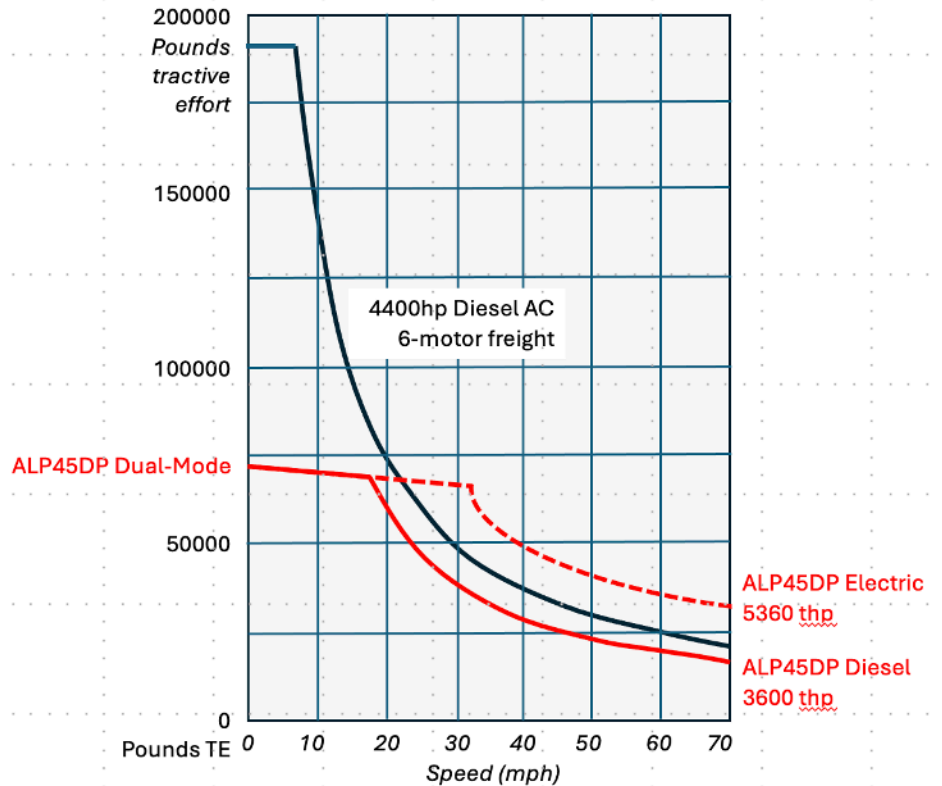

Figure 30. Tractive Effort Curve for the ALP45DP and Typical Line-haul Freight Locomotive

The ALP45DP was designed so that the transition from electric mode to diesel-electric mode (and vice versa) can be accomplished while moving, although NJT restricts such transitions to when the train is stationary.

7.4.4.2 Delivery

Sixty ALP45DPs were built for and are operated by NJT in commuter service around New York City, on both electrified and non-electrified lines. Thirty-five units (with US EPA Tier 2 engines) were delivered in 2011-2012 and another 25 (with US EPA Tier 4 engines fitted with DEF-SCR exhaust after-treatment technology) started delivery in 2021.

The units give NJT the flexibility to use a single locomotive for commuter trains operating on lines in electrified territory, outlying non-electrified lines, and on lines crossing between those

territories.¹⁴ Previously, NJT had to replace an electric locomotive with a diesel-electric (or vice versa) at locations where OCS ends, creating long delays in the timetable.

An additional 20 ALP45DP were delivered in 2011-2012 to EXO for rail commuter operation in Montreal. These units operated along non-electrified lines and the electrified 25 kV 60-hertz former-Canadian National (CN) Deux-Montagues commuter rail line until 2020 when the electrified line was decommissioned. The 20 dual-mode ALP45DPs in Montreal now effectively operate as conventional diesel-electric locomotives.

The most recent ALP45DPs being acquired by NJT cost US\$8.81 million each (NJ Transit, 2009). By comparison, a 4,300-4,400 hp EPA Tier 4 line-haul freight locomotive would cost approximately US\$3.3 million. As already stated, multiple ALP45DPs would be required for each conventional locomotive replaced. The ALP45DP’s smaller, higher speed diesel engines, traction alternators, traction motors, and wheelsets are not used in high-power US diesel-electric freight locomotives, creating an additional challenge for freight railroad maintenance practices and parts management. Combined with the higher cost, the ALP45DP would not work as a drop-in solution for the North American freight rail industry, but much can still be learned by studying the locomotive’s design process.

Development and delivery of the first fleet of ALP45DP electro-diesels for NJT occurred over a 6-1/2-year timeline, as detailed in Figure 31 below (NJ Transit, 2009). Even though the ALP45DP was a derivative of similar existing Bombardier electric and diesel-electric locomotives, the dual-mode capability created significant engineering hurdles.

Time-Line

YEAR	QTR	EVENT
2006	1	Specification Development
	3	Industry Review
2007	2	Advertised RFP
	4	Bombardier Selected as the Builder
2008	3	Board approval - NTP (Notice To Proceed)
2009	1	
	2	Preliminary Design Complete
2010	1	Final Design Complete
2011	1	Prototypes scheduled for Pueblo testing
2011	4	Revenue service start
2012	3	Production completion
2013		Warranty
2014	3	Warranty completion



Figure 31. NJ Transit ALP45DP DML Development Timeline

¹⁴Passenger locomotives and freight locomotives tend to have different prices for a variety of reasons, so a direct comparison in valuations should be handled cautiously for economic analysis.

7.4.5 Siemens ALC-42E Dual-mode Passenger Locomotive with Powered Coach

In July 2021 Amtrak announced a US\$7.3 billion commercial order with Siemens Transportation for 73 (later increased to 83) passenger trainsets to be delivered between 2026 and 2030 (National Passenger Railroad Corporation, 2021). The ALC-42E is a dual-mode variant of the Siemens Charger locomotive family, and it constitutes 58 of the trainsets in the order. The lead element of the trainset is an ALC-42 modified to have a DC link connecting it to an Auxiliary Powered Vehicle (APV) coach. Both the locomotive and the APV coach have four traction motors. While the locomotive has high-speed diesel engines (with an emissions profile in compliance with the EPA’s Tier 4 standards), the APV coach either has a battery system (32 trainsets in the order) or electrical equipment to interface with an OCS (26 trainsets in the order).

The DC link allows for power from the coach to drive the locomotive’s traction motors during electric operations, but the ALC-42E is not designed to run the coach’s traction motors with power from the diesel engines, meaning diesel operations use reduced power similar to the ALP45DP or the SD40-2 DPL. Figure 32 shows the configuration of the ALC-42E locomotive and an APV powered coach with pantograph and electrical transformers (Worrell, 2022). The transformer can accept multiple OCS voltages (12.5 kV and 25 kV for Amtrak’s NEC). The APV coach configuration for the battery version would be like that shown in Figure 32 except the battery-electric APV coach would not have a pantograph, transformer, or other electrical equipment necessary for interfacing with the OCS.

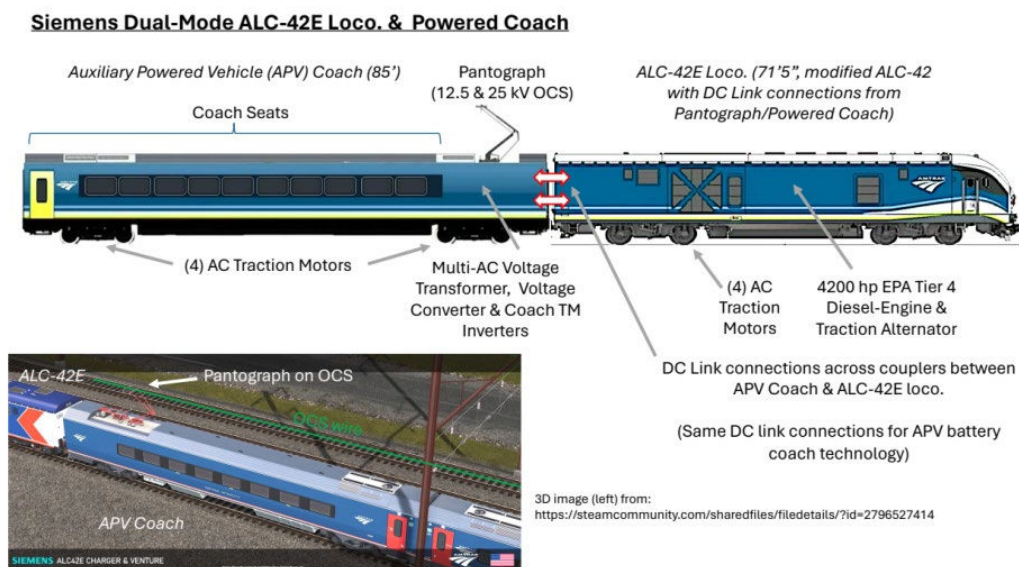

Figure 32. ALC-42E Dual-mode Locomotive and APV Coach

When operating in diesel-electric mode with the APV coach unpowered, each trainset would have a rated power of 4,200 hp (3,150 kW). In electric-mode each trainset is estimated to have more than 6,000 hp (4,500 kW). As a passenger locomotive, some of the power will be diverted to HEP, and the trainset is designed to have regenerative braking take over some of the HEP load. While this power is comparable to a freight line-haul locomotive, the ALC-42E lacks the tractive effort required for freight operations, similar to the ALP45DP.

7.4.6 Conversion of AC Diesel-electric Freight Locomotives to Dual-mode

While modern DMLs have been built for passenger rail applications, the 1981 FRA report shows that a DML for freight applications can be technically sound. This section discusses the process of converting an existing modern AC diesel-electric freight locomotive into a DML, the requirements for such a platform, and the advantages and disadvantages compared to designing a purpose-built DML.

7.4.6.1 Advantages and Disadvantages of a Redesign

A dual-mode freight locomotive created by modifying an existing AC diesel-electric freight locomotive can likely be engineered, designed, tested and validated, and produced in less time than required to design an entirely new DML. Using existing AC diesel-electric locomotives as the basis for a dual-mode conversion can be the lowest-cost and shortest time approach to acquiring DMLs for several reasons:

- Capital investments can be minimized by re-using most of the existing AC diesel-electric locomotives
- A shorter production timeline can be achieved compared to designing an entirely new DML
- The investment in legacy diesel engines and traction alternators can be retained, minimizing future replacement parts and training requirements for the railroads

7.4.6.2 Alternatives for Dual-mode Conversions

There are two alternatives for converting existing diesel-electric locomotives; both will require engineering, design, testing and validation, and the production of tenders to support the two types of dual-mode conversion locomotives. Version one locates all high-voltage electrical equipment onboard a modified AC diesel-electric locomotive, which must be coupled/connected to a diesel fuel tender (DFT) as almost all the conventional diesel fuel tank must be sacrificed to provide space and weight allowance for new electrical hardware. Version two minimizes the placement of high-voltage electric equipment onboard the AC diesel-electric locomotive, which must be coupled/connected to an electric power tender (EPT) allowing connectivity to energized OCS for electrical power.

As described earlier for BELs with battery tenders, similar locomotive technologies, such as hydrogen fuel cell locomotives or battery locomotives, will also require tenders for adequate range.

The likeliest candidate locomotives for conversion to dual-mode would be 4,300-4,400 hp 6-axle locomotives with AC traction motors, such as:

- Wabtec/GE AC4400, ES44AC, and ET44AH
- Progress Rail SD70MAC and SD70ACe

7.4.6.3 General Conversion Process

The final electrical transmission on AC diesel-electric locomotives is the DC link connecting the diesel engine-alternator (producing variable frequency AC power), alternator rectifiers (converting the AC into DC power), the traction motor inverters (converting the DC link's DC

power into controlled frequency AC), and the AC traction motors. The DC link also handles power from the AC motors in dynamic braking (i.e., AC power converted back into DC at the inverters) to be directed to the diesel-electric locomotive's dynamic braking resistor grids.

The same DC-to-AC technology is used on contemporary electric locomotives, hydrogen fuel cell locomotives (H₂FCL), and BELs. In effect, controlled DC power of the necessary DC voltage and current from the power plant (e.g., diesel engine/alternator/rectifier, fuel cells, OCS/transformer/rectifier, or batteries) can be interchangeably directed into the DC link. Figure 33 shows the DC link of an AC diesel-electric locomotive while Figure 34 shows the DC link of an AC electric locomotive. Note the similarities in the two configurations, particularly in the components after the DC link.

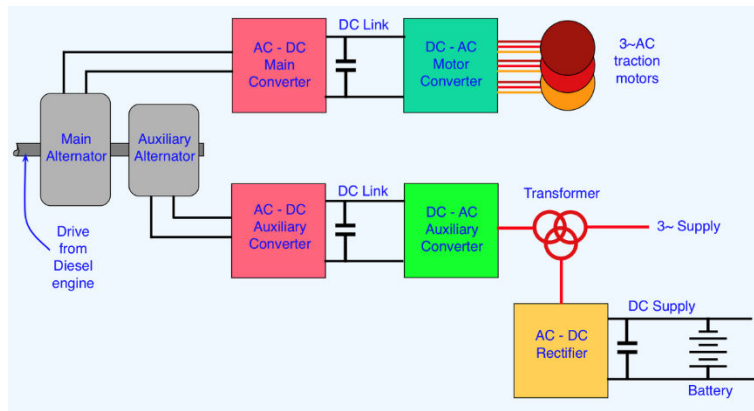

Figure 33. DC Link of an AC Diesel-electric Locomotive

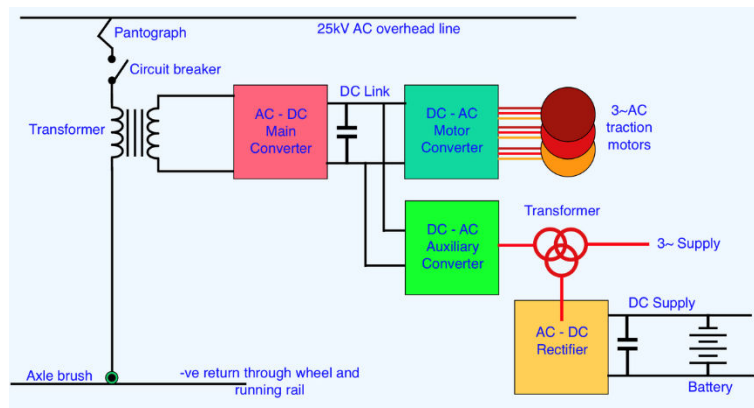

Figure 34. DC Link of an AC Electric Locomotive

DC links typically operate at voltages of 600 V to 2,000 V. Progress Rail/EMD locomotives operate at roughly 600 V to 2600 V, while Wabtec/GE locomotives operate at roughly 600 V to 1,400 V. The range in DC link operating voltages will present a technical challenge but should not be a barrier.

7.4.7 Specific Concepts for Conversion to Dual-mode Configurations

This section discusses two alternative (see Table 25 in Section 7.4.7.3) DML concepts, both of which use either a DFT or EPT.

7.4.7.1 Conversion Using a DFT

Figure 35 shows the primary components that would need to be altered to convert an AC diesel-electric locomotive into a DML compatible with a DFT. This conversion sacrifices almost all the 5,000-gallon (19,000 L) diesel fuel tank. The tank itself weighs 12,000 pounds (5400 kg), with another 35,000 pounds (16,000 kg) of weight for the diesel when full. Replacing this tank with a much smaller 500-gallon (1900 L) fuel tank would allow the locomotive to make independent movements without a tender or OCS available, and it would free space for a step-down transformer capable of accepting high-voltage AC current (HVAC) from the pantograph. A fuel transfer hose at the rear of the locomotive would allow a purpose-built DFT to supply diesel fuel for up to two DMLs (with the locomotives both facing away from the DFT), as shown in Figure 36.

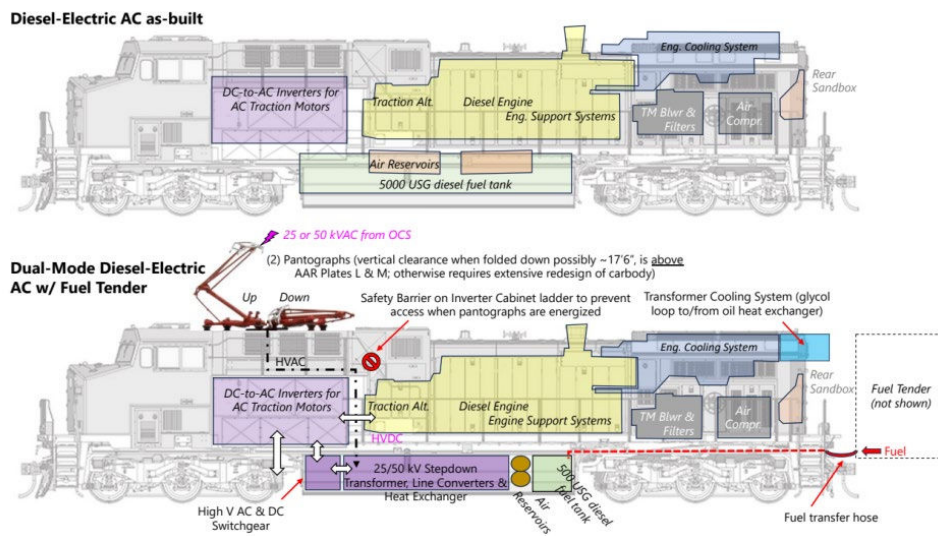

Figure 35. Diagram of the Primary Components in a Modern AC Diesel-electric Locomotive (top) and How They Would Be Shifted (bottom) to Convert the Locomotive to Accept Energy from an OCS or from a Fuel Tender

There would be space for significant design flexibility in the DFT itself, and it is likely that, overall, the two DMLs working in tandem with the DFT would have a greater diesel-only range than two equivalent diesel-electric locomotives. Figure 36 depicts a 12,000 gallon (45,000 L) DFT that would meet FRA's crash worthiness standards. Such a DFT could be built based on the current AAR Specification M-1004 for interoperable and crashworthy fuel tenders with design details supporting the carriage and delivery of liquid diesel-like fuels (allowing for future conversion to biodiesel or similar alternatives). Without a coupled fuel tender, this type of DML would not have a diesel-only range adequate for Class 1 railroad operations. Once a sufficient OCS network is built-out, this type of DML would be capable of short movements between OCS territories, or along short non-electrified spurs, without a coupled DFT.

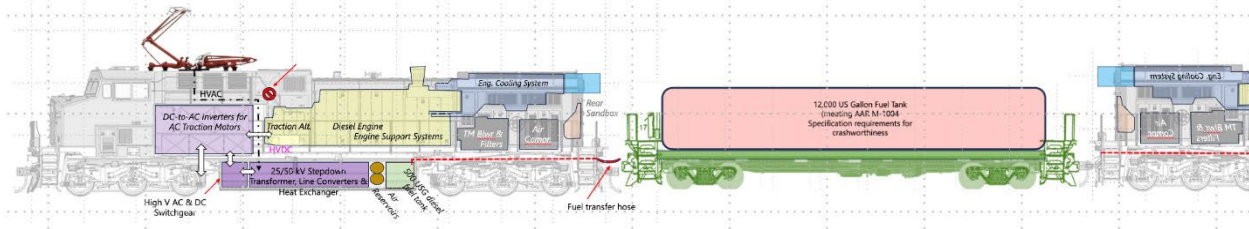

Figure 36. DFT Connected to Two Converted DMLs – the DMLs can Accept Chemical Energy from the Tender or Electrical Energy from an OCS

This is an extremely complex and technically challenging approach to converting an AC diesel-electric freight locomotive into a DML. Unlike the 1981 FRA proposal to convert an SD40-2 into a SD40-2 DML, contemporary diesel-electric locomotives do not have significant amounts of empty space into which new electrical hardware can be installed. Current AC freight locomotives are among the heaviest ever built, from 420,000 to 432,000 lb (191,000 kg to 196,000 kg) assuming a full fuel tank, which is near the weight limit for a 6-axle rail vehicle. AC freight locomotives built to US EPA Tier 4 standards are typically at the upper end of that range, meaning they may be among the most difficult to convert. This means converting older locomotives, in addition to yielding the largest marginal emissions reductions, would also be technically simpler.

The estimated mass of each component needing to be added or removed in the DML+DFT conversion process are summarized in Table 24. The net effect on weight is nearly zero, with some flexibility in the exact sizing of the final fuel tank. An AC4400 built to 420,000 lb (191,000 kg) could be converted into a DML for operation with a DFT with virtually no change in weight. Because some older locomotives use steel plates as a form of ballast to increase their maximum tractive effort, there is considerable room for flexibility in this type of conversion design. At the other end of the spectrum, a 432,000 lb (196,000 kg) Tier 4 freight locomotive would have very little margin for weight tolerance if one of the components is heavier than estimated. Tier 4 locomotives are also longer than other tiers because the EPA Tier 4 engines and cooling systems (i.e., radiators) are slightly longer. This difference in size means that such locomotives would require a different conversion kit, and that certain components such as the cabling and fuel hose might need to be heavier to accommodate longer lengths.

Table 24. Weight of Removed or Added Components Involved in the Theoretical Conversion of a Wabtec/GE AC4400 Freight Locomotive into a DML

Component	Weight (lb)	Mass (kg)
Remove 5,000 gallon diesel fuel tank	-12,500	-5,770
Replace with 500 gallon diesel fuel tank	+1,800	+820
Reduce maximum diesel volume by 4,500 gallons	-31,500	-14,300
High-voltage transformer with cooling oil, low-profile	+19,180	+8,700
Line converter, AC-to-DC	+7,000	+3,200
Additional switchgear, cabling, etc.	+4,000	+1,800
(2) pantographs & associated hardware	+4,000	+1,800
Transformer oil cooling radiator, piping, pumps, etc.	+8,000	+3,600
Estimated total weight shift	-20	-150

For all tiers, a converted DML with DFT would likely have more consistent traction due to lower weight variability in transit. The weight of the diesel fuel onboard the locomotive currently shifts from about 35,000 lb (16,000 kg) in a full tank to 3,500 lb (1,600 kg) in a nearly empty tank (10 percent of fuel remaining), a change of up to 7.5 percent of the overall weight of the locomotive. Maximum tractive effort depends on the weight of the locomotive and the adhesion of the wheels along the rails. A DML with DFT developed using this conversion process would have nearly the same weight at empty as at full. Technically, the available tractive effort (i.e., drawbar pull) for the entire train would rise as the DFT becomes lighter.

The high-voltage transformer used in this DML conversion will be a low-profile design such as that used in the Alstom/Bombardier IORE 6-axle electric freight locomotive for LKAB in Sweden detailed earlier in this report. The IORE locomotive (Kiruna Electric Locomotives) is a 6-axle 6-motor AC electric locomotive relatively similar in shape and size (75' 1-3/4" long) to contemporary US AC diesel-electric locomotives. Figure 37 shows the side-view of an IORE electric locomotive with its low-profile high-voltage transformer located between the trucks (a close up of this low-profile high-voltage transformer is also shown separately in the figure).

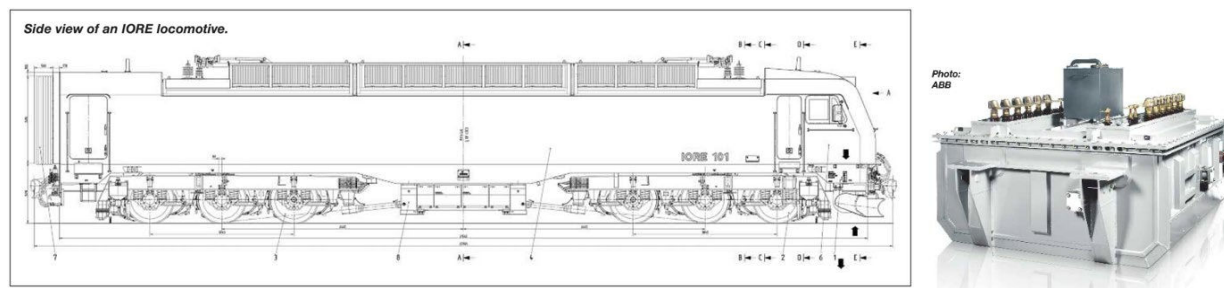

Figure 37. Side-view of Swedish IORE Electric Freight Locomotive and Close-up of its Low-profile High-voltage Transformer

The IORE electric locomotive is rated at 7,200 hp (5,400 kW) continuous power, whereas a US AC diesel-electric locomotive conversion into DML only would need to retain the 4,400 hp (3300 kW) rating (with a 10 percent allowance for overload operation drawing power from OCS). Therefore, the IORE transformer, weighing 14,000 kg (31,000 lb), appears to be oversized for the proposed AC4400 DML conversion. The design of a low-profile high-voltage traction transformer purpose-built for the needs of North American line-haul freight locomotives is a crucial element for a DML conversion. The estimated weight for this component, based on a linear reduction from the traction transformer in the IORE, is one of the areas of greatest uncertainty in the conceptual design presented here.

One other important design consideration is the installation of two pantographs proposed to be on the roof above the AC4400 dynamic brake compartment. This method reduces the number of components inside the locomotive chassis that need to be shifted or redesigned, but it does increase the locomotive's overall height. As shown earlier in Figure 35, this creates a vertical clearance issue as the pantographs would exceed AAR Clearance Plates L and M when lowered. This means that locomotives undergoing this type of conversion would be restricted from certain parts of the rail network, such as not passing through various maintenance shop doorways, through power plant rotary dumpers, and other areas of low clearance.

One alternative would be to redesign the entire dynamic brake cabinet. By reducing its height sufficiently, the pantographs could fit beneath the height of the locomotive's existing vertical

profile when stored. Another alternative would be to entirely remove the dynamic brake compartment from its current location on the roof behind the operator cab and reposition it above the diesel engine midway along the locomotive's length.

Figure 38 shows this alternate configuration. While there appears to be physical space for such a relocation, this alternative has several drawbacks. Lowering the pantographs in this way would create a space behind the cab for aerodynamic eddy currents to form, increasing the locomotive's overall air resistance. For most trains, particularly higher speed intermodal trains that do not need the lower clearance, this alternate configuration would decrease the overall efficiency of the train. Secondly, locating the dynamic brake compartment above the diesel prime mover could interfere with heat flow within the locomotive and lead to inefficiencies or increase engine maintenance. Lastly, and perhaps most importantly, the space above the diesel engine is intended to make the removal or replacement of various heavy engine components (e.g., engine power assemblies) with shop cranes faster and easier. This alternate configuration would require the dynamic brake compartment to be disconnected and removed before such engine maintenance, and re-installed afterwards, greatly increasing the downtime and labor cost for such DMLs.

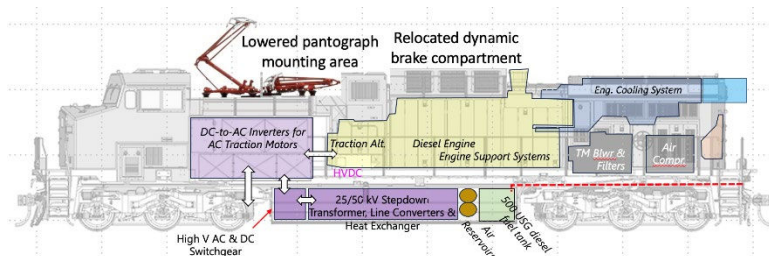

Figure 38. Alternate Configuration for a DML with DFT Relocating the Dynamic Brake Compartment to Allow Room for Pantographs without Increasing Locomotive Height

7.4.7.2 Conversion Using an EPT

Unlike the DML configuration using a DFT, this DML configuration places most of the additional high-voltage electrical equipment on an EPT that would be coupled and connected to the AC4400 DML to operate using power from energized OCS in zero-emissions mode. This DML configuration is much more like an existing AC4400 locomotive, except for new high-voltage cabling, switch gear, and other small additions to provide connectivity with the EPT (Figure 39). The diesel-only operating range of the configuration would be practically identical to the pre-converted AC4400 (the range is reduced by roughly 10 percent, but would still be adequate for typical distances between refueling stops), and the locomotive would be capable of continuing normal operations while disconnected from the tender.

Figure 39 shows the placement of the principal components in this type of conversion. The small number of additional components can be accommodated by reducing the size of the fuel tank by only ten percent, from 5,000 gallons (19,000 L) to 4,500 gallons (17,000 L).

The primary downside of this option is that the EPT would house complex components, such as the step-down transformer, pantographs, and other electrical equipment necessary for interfacing with the OCS, which would likely make each EPT more expensive than each DFT. One EPT might be able to draw power for several locomotives in a series, unlike the maximum of two locomotives per DFT, making the overall cost comparison more complicated. Additionally, an EPT would, in theory, have room for batteries in addition to the electrical equipment, making it

possible for this type of DML to have some all-electric operations outside of OCS territories. If there is room to lay multiple high-voltage lines during the conversion process, it might also be possible to use regenerative braking during diesel-powered operations by diverting electrical energy from the dynamic brakes to the batteries onboard the EPT rather than the resistor grids in the dynamic brake compartment.

Diesel-Electric AC as-built

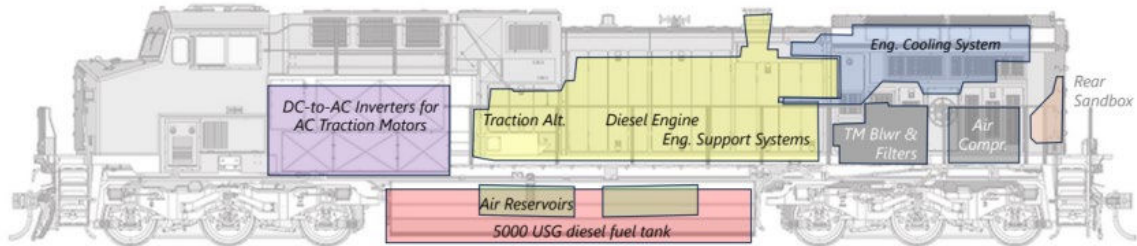

Dual-Mode Diesel-Electric AC w/ Electric Tender

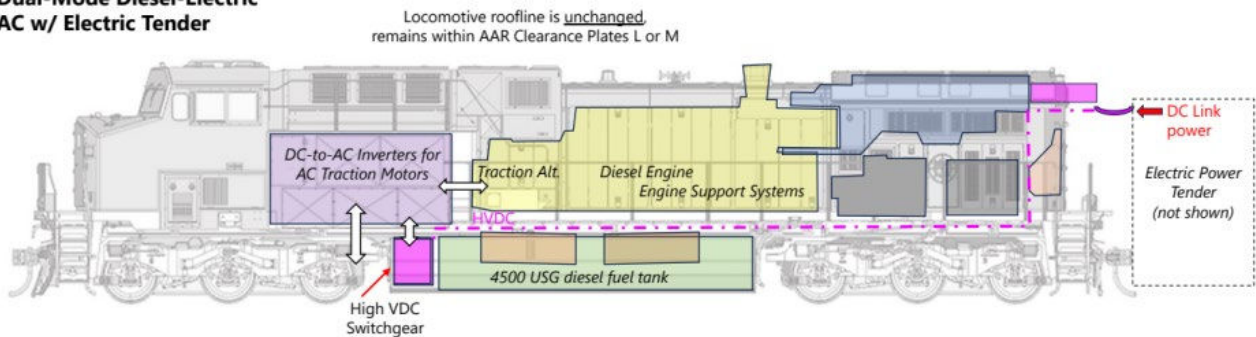

Figure 39. Primary Components of a Conventional AC Diesel-electric Locomotive (top) and a Converted DML Using an EPT

Another upside for this configuration compared to using a DFT is that the locomotive’s roofline remains unchanged. The locomotive would remain within AAR Clearance Plates L or M, and there would be no change in the process required for accessing heavy engine components for maintenance. It should be possible to design the EPT so it would also fall within the relevant clearance plate while its pantographs are retracted.

Figure 40 shows a graphical summary of this proposed DML+EPT (eTender in the graphic) concept of a dual-mode capability for a modified diesel-electric locomotive. The configuration allows for operation as an electric locomotive in OCS territory, and possibly as a battery locomotive outside OCS territory when the EPT is also outfitted with batteries, while also retaining full diesel-electric capability when OCS is not present. This flexibility is key to supporting electrification schemes where OCS is installed only along segments of a corridor, or where substantial traffic uses only a portion of an electrified corridor to access other non-electrified lines.

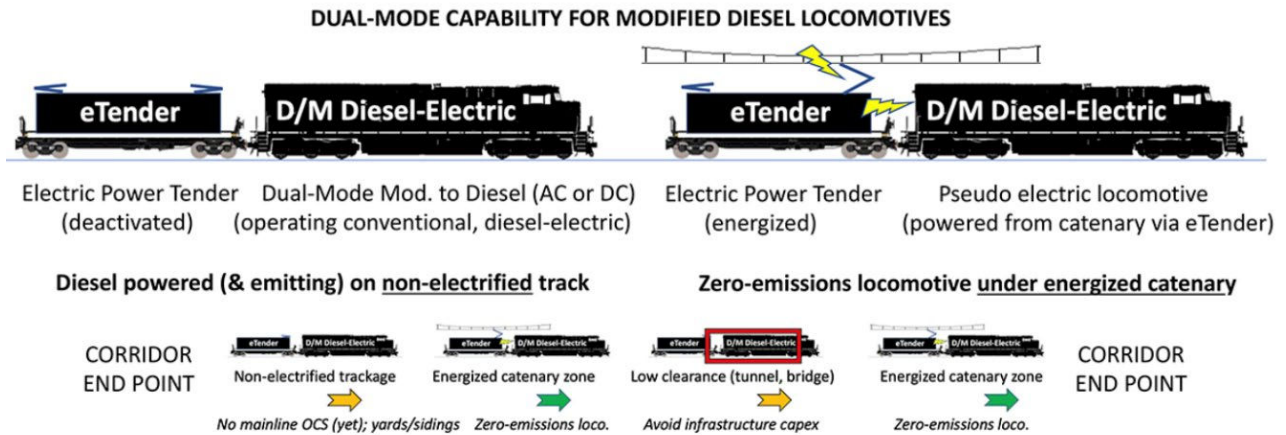

Figure 40. Relationship of the DML with EPT (i.e., eTender) to Electrification Schemes with Partial OCS

7.4.7.3 Comparison of Conceptual Dual-mode Conversion Alternatives

The characteristics, advantages, and disadvantages of the two proposed concepts to convert existing AC traction diesel-electric locomotives into DML are summarized in [Table 25](#).

Table 25. Direct Comparison of the Two Proposed DML Conversion Concepts

Conversion with DFT	Conversion with EPT
Conversion from diesel-electric to dual-mode appears to be physically and technically feasible if various compromises are accepted.	Conversion from diesel-electric to dual-mode would require minimal redesign of the locomotive, and would not face any clearance issues.
The configuration involves extensive redesign of existing locomotive hardware to place the needed high-voltage electric equipment onboard the locomotive, and to maintain existing AAR vertical clearance requirements.	
This alternative configuration requires a DFT to maintain normal long-distance operating range when using diesel only; without the DFT this DML configuration would have a liquid-fuel operation range of less than 10 percent of existing range (estimated 150 miles compared to 1,500 miles).	This DML configuration would be able to continue normal operations without a tender, and would have roughly the same liquid-fuel operating range.
This configuration would use a relatively simple and inexpensive tender, which could provide chemical energy for up to two locomotives in a train.	This configuration would use a tender with more expensive components. Each train would require locomotive tenders to make any use of existing OCS. One tender would be able to supply power to multiple locomotives grouped together.
Electric propulsion would only be possible within OCS territories. The train would only be able to take advantage of regenerative braking during fully electric operations.	The electric power tender in this configuration could potentially have room to accommodate large battery energy storage, allowing for some carbon-free propulsion outside OCS territories, and potentially higher diesel fuel efficiency during liquid-fuel operation.

7.5 Comparison of Alternative Locomotive Technologies

This section compares the locomotive technologies for mainline freight rail electrification from the previous sections, as well as hydrogen fuel cell locomotives. The team compared the overall electrical/thermal efficiency, TRL, and CRI, and analyzed the strengths, weaknesses, opportunities, and threats (SWOT) of each technology.

7.5.1 Relative Efficiency of Alternative Locomotive Technologies

Figure 41 illustrates energy flows and estimates of the electrical/thermal efficiency of diesel-electric locomotives, H₂FCLs, BELs, and electric locomotives operating on OCS. The values at left indicate how much electricity (i.e., diesel fuel energy) is required to deliver an equal amount (1 MWh) of usable energy (i.e., traction work) at the wheel/rail interface. The flows from left to right show the intermediate losses and relative efficiency of each energy conversion step between the electrical grid (i.e., tank) and the wheels.

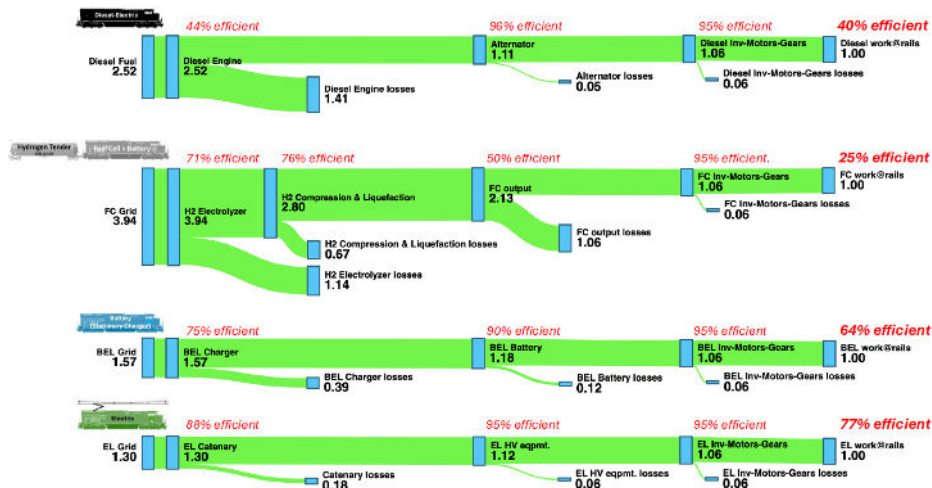

Figure 41. Efficiency Comparison of Various Locomotive Technologies

Electric locomotives are estimated to be the most efficient alternative (77 percent). A DML with EPT operating in diesel mode is expected to be slightly less efficient than conventional diesel-electric locomotives that are approximately 40 percent efficient, and the losses introduced by the extra weight and transfers involved with an EPT will only slightly reduce the theoretical electrical/thermal efficiency.

Due to the additional inefficiencies of battery charging, storage, and discharge, a BEL is less efficient than electric locomotives with OCS. Additionally, a BEL requires the purchase of an extra 0.27 MWh of electricity for every 1 MWh of work compared to a straight electric with OCS, representing a 21 percent increase in energy costs. However, this efficiency calculation does not account for potential BEL efficiency gains through storage and re-use of energy from dynamic regenerative braking.

Although not detailed in this study, a hydrogen fuel cell locomotive using hydrogen produced via electrolysis makes the least efficient use of electricity. Due to the numerous losses in the multiple conversion steps required to produce, compress, and transform hydrogen into electricity for traction, H₂FCLs require the railroad to purchase (or pay for via the cost of hydrogen) an

additional 2.64 MWh of electricity for every 1 MWh of work compared to a straight electric with OCS. This 203 percent increase in electricity use relative to traditional electrification will have significant ongoing operating cost implications for railroads that elect to use hydrogen as opposed to more efficient OCS, DML, or BEL alternatives. Finally, a DML operating in diesel mode shows better thermal efficiency than an H₂FCL, but it produces significantly more mobile source emissions.

7.5.2 Reliability Growth Testing to Link TRL and CRI

TRL and CRI were previously introduced in the context of evaluating methods to streamline catenary construction. This section applies the same scales to seven different locomotive propulsion technologies:

1. Conventional diesel-electric locomotives
2. Proposed dual-mode (i.e., converted diesel-electric) locomotive with EPT
3. Battery electric locomotive with stationary charging
4. Battery electric locomotive with mobile charging from energized OCS
5. Hydrogen fuel cell + battery locomotive
6. Electric locomotive
7. Electric locomotive with “last mile” battery permitting short operation without OCS

Prior to evaluating the technology and commercial readiness of locomotive options, it is important to consider how these alternatives transition from technological development to the commercial marketplace. In the context of locomotive development and manufacturing, an important link between the technology development path (measured by TRL) and commercialization path (measured by CRI) is Reliability Growth Testing (RGT). RGT was developed in 1964 by General Electric as a tool for improving the reliability of military assets. A key premise of RGT is “... the process of operating-and-maintaining (under ‘real world’ conditions) a new product in preproduction phase (prior to full-scale commercial production) with incremental identification and correction of component failures” (Iden M. , 2021). Under RGT, reliability is defined as being “... a product’s ability to operate and perform as intended over a specified length of time under assumed operating and maintenance conditions without failing.”

RGT rigorously “shakes down” a new product (in pre-production form, i.e., short of being commercially available) by subjecting it to statistically valid periods of “real world” operation, maintenance, abuse, variable environmental conditions, etc., leading to, in most situations, failure of components or systems. The failed components or systems are subsequently removed, and examined so the failure cause(s) can be determined, and subsequent redesign implemented, reinstalled, and subjected to more real world use. When the overall reliability of the product (measured against a predefined reliability goal) reaches or exceeds the reliability goal, the design is considered ready for commercial sale.

There are numerous examples of locomotive design or technology failures on North America freight railroads that resulted from a lack of RGT:

- 6,000-horsepower diesel-electric locomotives (to achieve “2-for-3” unit reduction)
- Lead-acid battery electric locomotives

- Multi-engine “genset” locomotives
- Certain EPA Tier 4 emissions level diesel-electric locomotives

In each case, the new locomotive designs or new technologies were not properly shaken down before commercial sales and production began. The ultimate cost of these failures to pursue RGT included extremely short locomotive lives, early scrapping (and write-offs of capital value), and operational disappointments.

7.5.2.1 Assessment of Locomotive Technology Alternative TRL and CRI

In assessing the technological and commercial readiness of different locomotive alternatives, it is important to consider the locomotives, required tenders (if necessary), and the associated energy supply infrastructure. The ratings for each alternative assigned by the research team is summarized in Figure 42.





Locomotive Type	Efficiency		Zero Mobile Source-Emissions?	Infrastructure Required	TRL (Locomotive/ Infrastructure)	CRI (Locomotive/ Infrastructure)
	Tank to Wheels	Grid to Wheels				
 Diesel-Electric	40%	n/a	No	Existing diesel fueling	9 / 9	6 / 6
 E-Power Tender / Dual-Mode Diesel	~40%	~77%	Partial	Existing diesel fueling Partial OCS	4 / 9	1 / 6
 Battery (Stationary Charged)	n/a	64%	Yes	Stationary battery chargers	6 / 4.5	1 / 1
 Battery (OCS Charged)	n/a	~64%	Yes	Partial OCS	4 / 3	1 / 1
 Hydrogen Tender / Fuel Cell + Battery	n/a	24%	Yes	Hydrogen manufacturing, distribution and fueling	6 / 1	1 / 1
 Electric	n/a	77%	Yes	Full OCS	9 / 9	4.5 / 6
 Electric + Last Mile Battery	n/a	~77%	Yes	OCS with short gaps	9 / 9	4.5 / 6

Figure 42. Summary of Alternative Locomotive Technology TRL and CRI

Diesel-electric technology (particularly in North America) has been commercially available since the late 1930s (almost 100 years), and high-horsepower, US-design, diesel-electric locomotives are ubiquitous globally in demanding heavy-haul operations because of their maturity, reliability, and performance. They are rated at **CRI = 6** (the maximum on the CRI scale).

Correspondingly, there is a mature market for various types of **diesel refueling infrastructure** that all conform to one common nozzle-tank interface design, and thus it is also rated at **CRI = 6**. Large-volume refueling locations are capable of simultaneously refueling multiple locomotives.

The **DML with EPT** option has yet to be truly implemented for the North American freight market but the component technologies are mature. The Amtrak ALC-42E DML and APV coach for service on the NEC and connecting routes is equivalent to a commercial trial of the overall EPT concept, but for freight is still rated at **TRL = 4 (CRI = 1)**.

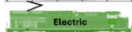
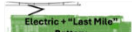
BELs with stationary charging are rated at **TRL = 6 (CRI = 1)**. One mainline prototype BEL was tested for several months in California by BNSF, a lower-power BEL was demonstrated on the Pacific Harbor Line in the Los Angeles-Long Beach twin ports area in Southern California, and a similar predecessor BEL is operated by Vale's EFC Railway in northern Brazil. While numerous orders for additional BELs have been placed, BELs using lithium-ion battery technology are in the very-early stages of development.

Stationary charger technology for BELs is rated at **TRL = 3 to 6 (CRI = 1)**. There is currently no rail industry-accepted standard for BEL charging hardware or operability, although several plug-in and "reverse pantograph" concepts are being demonstrated along with the prototype BELs.

Little progress has been publicly communicated regarding onboard en route charging systems. To be charged from OCS while moving, a BEL will require additional onboard electrical hardware to step-down the OCS AC voltage, convert the AC to DC, and integrate the incoming power with the battery management system and traction control system (if part of the power drawn from the OCS is simultaneously being used for traction). Because of this additional complexity, **battery electric locomotives with en route charging** are rated at **TRL = 3 to 4 (CRI = 1)**.

Hydrogen fuel cell + battery locomotives are rated at **TRL = 6 (CRI = 1)** for mainline freight service since, at the time of this report, there were only three prototype (not pre-production) hydrogen fuel cell locomotive units assembled by the CPKC Railway and experimentally operated in western Canada. Very little meaningful RGT shake down has occurred. The current test programs have provided an estimated equivalent of two locomotive unit-years of testing (compared to the suggested 35 to 50 locomotive unit-years of testing a pre-production locomotive design necessary to achieve RGT).

Hydrogen tender development is progressing, with at least one experimental compressed hydrogen tender operating on CPKC in Canada. The AAR is also continuing additional refinement of its Standard M-1004 for interoperable and crashworthy fuel tenders through development of a Standard sub-set for compressed and liquefied hydrogen tenders. As such, hydrogen energy tenders are at **TRL = 5 to 6** since no RGT shake down has occurred.

There has been no developmental work communicated regarding large-scale infrastructure to make **compressed or liquefied hydrogen fueling infrastructure** available in large quantities to North American freight railroads. As such, it is rated at **TRL = 1** with fundamental research still ongoing.

Electric and **electric with last-mile battery** locomotives are similarly ubiquitous globally (with limited examples in the US in passenger and commuter operation on the East Coast), and electric locomotive technology dates back into the 1880s. Although manufactured in the past and currently in service on several industrial railways, the lack of a current "commercial existence" of electric or electric with last-mile battery locomotives for the US freight market, either new designs or converted from existing diesel-electric locomotives, corresponds to **CRI = 4 to 5**.

Although only the NEC and several isolated industrial mining railroads are equipped with **OCS** in the US, its past use on freight rail projects domestically and widespread use on approximately one-third of rail corridors globally corresponds to **CRI = 6**.

7.5.3 Alternative Locomotive Technology SWOT Analysis

Each locomotive technology and energy source has its own fundamental strengths and weaknesses, and affords railroads different market-related opportunities while also introducing certain threats. A SWOT analysis of these different technologies documents potential drivers and obstacles for each technology that may influence the adoption of various modern options for freight rail electrification.

7.5.3.1 SWOT Analysis Framework

A SWOT analysis includes four components designed to highlight synergies between strengths and market opportunities, and the detrimental alignment of weaknesses and threats:

- **Strengths** are fundamental factors internal to a technology that provide it with an advantage over competing technologies. For example, does a locomotive alternative have lower energy use or cost that can achieve decarbonization with less maintenance and infrastructure relative to competitors?
- **Weaknesses** are fundamental factors internal to a technology that place it at a disadvantage relative to competing technologies. For example, does a locomotive technology have great uncertainty in costs, ROI, and development and implementation timelines due to low technical and commercial readiness?
- **Opportunities** are external factors that can be exploited through adoption of the technology. For example, does the locomotive technology have potential for performance improvements and increased market share, the ability to generate additional public benefits that can be valued, or to leverage non-railroad research and development to improve future efficiency?
- **Threats** are external factors that can cause problems for adoption of a technology. For example, is a locomotive technology particularly vulnerable to market price fluctuations, material availability, and the risk of impactful regulatory decisions?

7.5.3.2 SWOT Analysis and Comparison

To provide a broader context for modern locomotive options for freight rail electrification, the project team evaluated the system-related strengths and weaknesses of various locomotive technologies and energy sources, and considered their market opportunities and risks. The following locomotive technologies and energy sources were evaluated:

- Diesel-electric (baseline)
- Alternative diesel fuels (e.g., biodiesel and renewable diesel)
- Compressed or liquefied natural gas (i.e., methane)
- Hydrogen fuel cells
- Methanol in diesel engines
- Electricity via OCS
- Batteries
- Dual-mode: modified diesel-electric with EPT

- Dual-mode: modified diesel-electric with batteries
- Dual-mode: electric with last-mile batteries

The SWOT analysis is summarized in [Table 26](#).

Table 26. Alternative Locomotive Technology SWOT Analysis

Locomotive or Energy Type	Strengths	Weaknesses	Opportunities	Threats
Diesel-electric (baseline)	-Current universal and flexible fleet -Mature technology -Existing skillsets	-Mobile emissions -Dependent on carbon fuels -High NO _x /PM	-AC traction platform supports remanufacturing into alternate tech	-Pending emissions regulations -Decarbonization goals and targets
Alternative diesel fuels	-Potential “drop-in” to replace diesel -Some emissions benefits, possibly net-zero	-Lower energy density than diesel -Mobile emissions -Biodiesel increases NO _x	-Production is commercializing but has limited capacity	-Availability of supply and impact on food production -Demand from aviation mode
Natural gas (i.e., methane)	-Feasible in newer engines -In limited revenue service	-Mobile emissions -Requires tenders -Safety risks -Methane leakage	-Potential for renewable natural gas as a bridge technology	-Pending emissions regulations -Decarbonization goals and targets
Hydrogen fuel cell	-No mobile-source emissions -Overall emissions depend on source of hydrogen	-Poor overall efficiency -Requires tenders -Complexity of high-power cells -Safety risks	-Leverage third-party investments in hydrogen supply and production	-Lack of true zero-emissions hydrogen production -Commercialization failure of hydrogen supply industry
Methanol	-Reduction in CO ₂ emissions	-Mobile emissions -High flammability -Extensive engine redesign required	-Leverage domestic production sources	-Availability of supply and impact on food production
Electricity via OCS	-No mobile-source emissions -Best efficiency -Mature globally	-Extensive OCS infrastructure -Operations tied to OCS infrastructure	-Leverage utility partnerships for co-location of transmission	-Overall grid supply of renewable electricity -Permitting OCS
Batteries	-No mobile-source emissions -Rapidly improving technology	-Tenders due to low energy density -Thermal sensitivity and short lifespan -Charging time and new infrastructure	-Leverage growing supply base for trucks and autos -Cascade to stationary battery applications	-Grid supply of renewable energy -Supply of battery materials and production capacity
Dual-mode diesel with EPT and partial OCS	-Leverage partial OCS infrastructure -Routing flexibility -Reduced emissions	-Mobile emissions -Engineering new power tenders and diesel conversions	-Bridge technology to full OCS or OCS with batteries	-Grid supply of renewable energy
Dual-mode diesel with batteries	-Reduced emissions -Routing flexibility	-Mobile emissions -Requires battery tender for range	-Bridge technology to other dual-mode options	-Grid supply of renewable energy -Battery supply
Dual-mode electric with batteries and partial OCS	-Leverage partial OCS infrastructure -Routing flexibility -No mobile-source emissions	-May need tenders -Thermal sensitivity and short lifespan -Charging time and new infrastructure	-Bridge technology to full OCS	-Grid supply of renewable energy -Battery supply

Diesel-electric locomotives comprise most of the current fleet of mainline freight locomotives in the US. The technology is mature and railroads and manufacturers have an established skillset to build, service, and maintain diesel-electric locomotives. However, the current fleet is dependent on a carbon-based fuel and produces mobile emissions of greenhouse gasses, NO_x, and particulate matter. Reducing these emissions is required for freight railroads to meet corporate emissions targets and sustainability goals, and may be forced by pending in-use locomotive emissions regulations. The current fleet of AC traction diesel-electrics offers a potential platform to be converted into various other alternative locomotive propulsion technologies, maximizing the use of existing components and proven designs where possible.

Alternative diesel fuel, such as biodiesel or renewable diesel, has been tested in freight rail applications and is seeing some railroad use as a “drop in” replacement to fuel that can possibly achieve net zero emissions. However, both biodiesel and renewable diesel produce mobile-source emissions, with biodiesel producing higher levels of NO_x than standard diesel. Switching to these fuels can allow railroads to leverage rapidly commercializing production sources, but railroads will face strong competition from other modes (e.g., aviation) that have fewer electrification options. Thus, the overall availability of supply is a threat, along with the potential impact of land allocated to production of alternative diesel on the supply and cost of food produced by agriculture.

Natural gas (i.e., methane) is currently in mainline freight revenue service on the Florida East Coast Railroad, and is a feasible fuel source in many new engines that were designed to be flexible in terms of fuel source. Natural gas produces mobile-source emissions and its energy density requires the use of a fuel tender to achieve the operating range of diesel. Natural gas also poses various safety risks and the greenhouse gas and climate change impacts of methane leakage is a concern. Although renewable sources of natural gas can serve as a bridge technology until other options mature, it is subject to the same threat of regulation and sustainability goals as diesel.

Hydrogen propulsion via fuel cells eliminates mobile-source emissions, but overall emissions are dependent on the source of the hydrogen and the emissions associated with its production. The energy density of hydrogen will require the development of hydrogen energy tenders, introducing additional cost, complexity, and potential safety risk from transporting large volumes of hydrogen. Onboard hydrogen storage carries additional safety risks from potential hydrogen leakage inside tunnels and shop building facilities. While railroads are gaining experience with high-power fuel cells through prototype demonstration, the process of producing, compressing, storing, and using hydrogen is fundamentally less efficient than other technologies using electricity. Although hydrogen fuel cells avoid the need to install OCS, hydrogen will require extensive investment in new hydrogen production, supply, and fueling infrastructure. While railroads may be able to leverage third-party investments in hydrogen production and supply infrastructure, production of true zero-emissions hydrogen may not be enough to satisfy the demand of multiple transportation modes. While the other locomotive technologies utilize existing commercialized sources of energy, hydrogen fuel cell locomotives are ultimately dependent on the emergence of a commercial hydrogen supply industry, introducing tremendous risk. The failure of such a market to materialize would force railroads to build their own hydrogen production infrastructure, and impose a long-term efficiency penalty compared to other options.

Methanol has the potential to reduce but not eliminate greenhouse gas emissions. Methanol is highly flammable and will require new engine designs. While methanol can allow railroads to leverage domestic production sources, the overall availability of supply is a threat, along with the potential impact of land allocated to methanol production on the supply and cost of food produced by agriculture.

Electricity via OCS eliminates all mobile-source emissions and offers the most efficient use of electricity and energy of any option. While mature globally, several decades have passed since the last mainline freight rail electrification project in North America. OCS requires extensive infrastructure investment along mainlines, and the ability to operate with electric locomotives is directly tied to the scope of OCS coverage. The dispersed need for grid connections required to supply OCS on long railroad corridors may allow railroads to leverage partnerships with utilities to reduce costs of infrastructure and electricity in exchange for co-locating transmission along the railroad ROW. Threats to using electricity via OCS include the extensive permitting required to facilitate OCS construction, and the overall supply of renewable electricity to result in true zero-emissions operations. This latter point is a common threat to all options that use electricity from the grid.

Batteries provide another option for eliminating mobile-source emissions and represent a rapidly improving technology with a growing supply base of manufacturers due to demand for battery-powered trucks and automobiles. Railroads can leverage this manufacturing base to potentially reduce costs and gain efficiencies through the large research and development base of this broader transportation and stationary grid storage battery market. Cascading used locomotive batteries into stationary grid storage presents railroads with a potential opportunity. However, batteries will require tenders on most freight routes due to energy density constraints. The long-term performance of batteries in different weather conditions and railroad duty cycles remains an open research question, as does the development of high-power charging infrastructure. Current charging rates will impose substantial locomotive utilization penalties on battery locomotives and tenders. The charging infrastructure also represents a major investment, and battery locomotives are limited to operating between terminals with chargers. Finally, the overall supply of battery components and competition for production capacity with other modes pose a threat to battery electric locomotives.

Dual-mode diesel-electric with EPT and partial OCS offers routing flexibility and the ability to leverage partial OCS infrastructure or individual segments of OCS as they are energized during construction. Operations are efficient and produce no mobile-source emission in OCS mode, reducing but not eliminating overall emissions. The largest weakness of this approach is to design, develop, and commercialize new power tenders and an AC traction locomotive conversion process. However, the dual-mode platform provides a bridge technology pathway to full OCS or OCS with battery options that eliminates all mobile-source emissions. The complexity of this system and the supply of renewable grid energy are the major threats.

Dual-mode diesel with batteries offers reduced emissions with greater operational flexibility that is not tied to OCS construction. However, locomotives will need to visit terminals equipped with charging infrastructure to take advantage of battery mode outside of route and train-specific opportunities for charging via dynamic regenerative braking. It is likely that battery tenders will be required for substantial range in battery mode to achieve large diesel savings and emissions reductions, also introducing battery supply as a threat. As with other options using grid power, the supply of renewable electricity from the grid is a threat.

Dual-mode electric with batteries and partial OCS eliminates mobile-source emission while providing additional routing flexibility. This option can utilize partial OCS, reducing infrastructure investment. To traverse significantly long sections with no OCS, battery tenders may be required, introducing their cost and questions regarding battery lifespan, charging time, and utilization. However, en route charging in motion may reduce the need for chargers and improve locomotive and tender utilization. This dual-mode option can also serve as a bridge technology to electrics with full OCS in the future. Like the other options using batteries and electricity from the grid, future battery supply is a threat, along with the availability of renewable electricity to eliminate emissions completely.

7.5.4 Prospective Updated DML Research Project

Given the promise of dual-mode technologies to support modern options for freight railway electrification, a research program is recommended to experimentally convert an existing high-horsepower freight AC diesel-electric locomotive into a DML and to construct an experimental EPT to facilitate zero-emissions operation under energized OCS.

Participants in this program are suggested to include:

1. US DOT, FRA
2. US Department of Energy (DOE)
3. AAR
4. American Short Line and regional Railroad Association (ASLRRA)
5. The TTC in Pueblo, CO, managed by Ensco, Inc.
6. Locomotive manufacturers (e.g., Progress Rail Locomotive, Wabtec, Siemens Transportation, Alstom, etc.)
7. Locomotive remanufacturers (e.g., Knoxville Locomotive Works, National Railway Equipment, CAD Railway Industries, etc.)
8. Selected manufacturers of electrification hardware

TTC has the only electrified North American test track capable of testing (continuous operation at all common speeds) electric locomotives under 25 kV or 50 kV AC OCS. [Figure 43](#) provides a preliminary projected timeline for this project, assuming a project start in the first quarter of 2025.

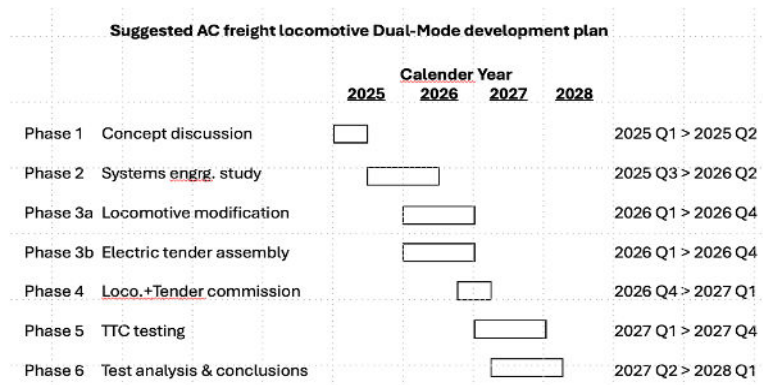

Figure 43. Proposed Timeline for a Future Dual-mode Freight Locomotive Research Project

8. Intermittent Electrification

OCS electrification can be “continuous,” meaning it is installed and energized across the full route between major end points, or “discontinuous,” meaning it is installed and energized in non-connected sections. Discontinuous or intermittent electrification can and should be seriously considered to support the operation of BELs to avoid unproductive time that a BEL is stationary while it is being recharged. However, in-motion recharging of a BEL also requires additional hardware to enable it to, for example, collect high-voltage AC from the overhead contact wire, split some of it into tractive power for the motors, and convert and condition the remaining power into the needed DC voltage for recharging the propulsion batteries. This adds complexity to the onboard battery management system (BMS), and requires hardware that takes away mass available for battery capacity. However, eliminating the need for stationary, non-productive recharging increases the BEL’s uptime and can mitigate the cost of the added complexity, while the possibility for en route recharging can mitigate the downsides of reduced battery storage.

The operational advantages of intermittent electrification are very similar to the advantages of DMLs discussed in [Section 7.4](#). The primary difference is that replacing the diesel-component of DMLs with batteries means intermittent electrification has the potential to provide carbon-free rail operations, but it also means intermittent electrification lacks the ability to fall back on the existing diesel infrastructure railroads possess. In the process of decarbonizing the rail industry, DMLs might provide a step toward eventual intermittent electrification, which might itself give way to full electrification as the OCS network is built-out on the busiest rail corridors.

Intermittent electrification allows railroads to achieve the benefits of electrification while avoiding the costliest areas to construct OCS, such as:

- Underneath low-clearance overhead structures such as bridges or tunnels
- Passing tracks adjacent to mainline tracks
- In yards and terminal areas

8.1 Concept of Electrification as a Spectrum

It is possible that, on the same route, some segments will be best electrified through use of OCS while others will require batteries. This can even vary over time. For example, the longer-term investment of OCS may not be viable for a particular segment on a five-year time horizon, but it might be at 10 years or even longer. Much research into rail decarbonization has focused on batteries, conventional OCS, or other technologies, but there might be more feasible cases for electrification when technologies are adapted to work in tandem. At first glance, it may seem odd to consider a battery-OCS hybrid system as distinct from OCS or batteries, but there are reasons for this framework:

- When OCS and batteries are combined the train’s operating characteristics can be very different from OCS or battery on their own
- It is possible to selectively choose where OCS is implemented in a hybrid system to minimize the infrastructure cost

To the first point, with a combined system, a train can recharge its batteries en route using the OCS. This means that the train will not experience the large logistics or recharging delays

inherent to solely battery-electric operations. The train is also able to utilize batteries to travel on parts of the network that do not have OCS, eliminating one of OCS's main drawbacks. However, recharging en route means that the battery-electric locomotives or battery tenders must have recharging hardware onboard, reducing the space that can be used for battery capacity when compared to pure battery operations in which the charging can always occur at a dedicated charging station (Iden M. , 2021, p. 11).¹⁵

There are several ways OCS and batteries can work together. The simplest, though not very efficient, way is to have the two systems on the trainset entirely separately, for example with OCS locomotives and battery locomotives that operate independently. In this example, the train could come to a stop at the end of an OCS segment, turn off the OCS locomotives, and then continue its route with the battery locomotives. Much more practical are operations where the two technologies are combined. To take another example, a train could use batteries when there is no OCS. Once it is under an OCS, the OCS provides the tractive power as well as excess power with which to recharge the batteries. Ideally, the transition from OCS to battery power occurs seamlessly, with no schedule delay. NJT, which operates locomotives capable of switching between OCS and diesel modes, only deploys the locomotive pantographs while the train is stopped (NJ Transit, 2009). Research is needed to investigate this operational decision, and determine the practicality for switching between modes en route without stopping.

Within the scope of intermittent electrification, there is a distinction between systems that primarily use batteries for propulsion with short segments of OCS for the purpose of recharging the batteries (i.e., Battery-OCS hybrid operations), and systems that primarily use OCS for propulsion with small battery capacity onboard to bridge shorter gaps in the OCS territory (i.e., OCS-battery hybrid operations). [Figure 44](#) illustrates the difference between these two systems. Because there is no hard delineation between the hybrid approaches, it is helpful to think of intermittent electrification as a spectrum with full battery operations on one end and full OCS operations on the opposite end. For a given corridor, the topography and traffic composition will determine the economically optimal point along this spectrum for full decarbonization.

As with DMLs or fully battery-electric systems, intermittent electrification might rely on tender cars to increase the train's OCS-independent range. With a sufficiently robust OCS network, it might be possible to use only the batteries onboard the locomotives and forego tenders. One likely business case will be for tenders to be reassigned from one area of the rail network once that area's OCS reaches sufficient saturation, and moved to another area where electrification is only beginning. The size of the batteries will be important, and more batteries may be required to complete some routes, creating logistical challenges in moving charged batteries to the right locations.

¹⁵ In addition to an extendable pantograph on each locomotive or tender, en route recharging would require stepdown transformers, rectifiers, and converters, which could all be located trackside when recharging is performed only at dedicated sites.

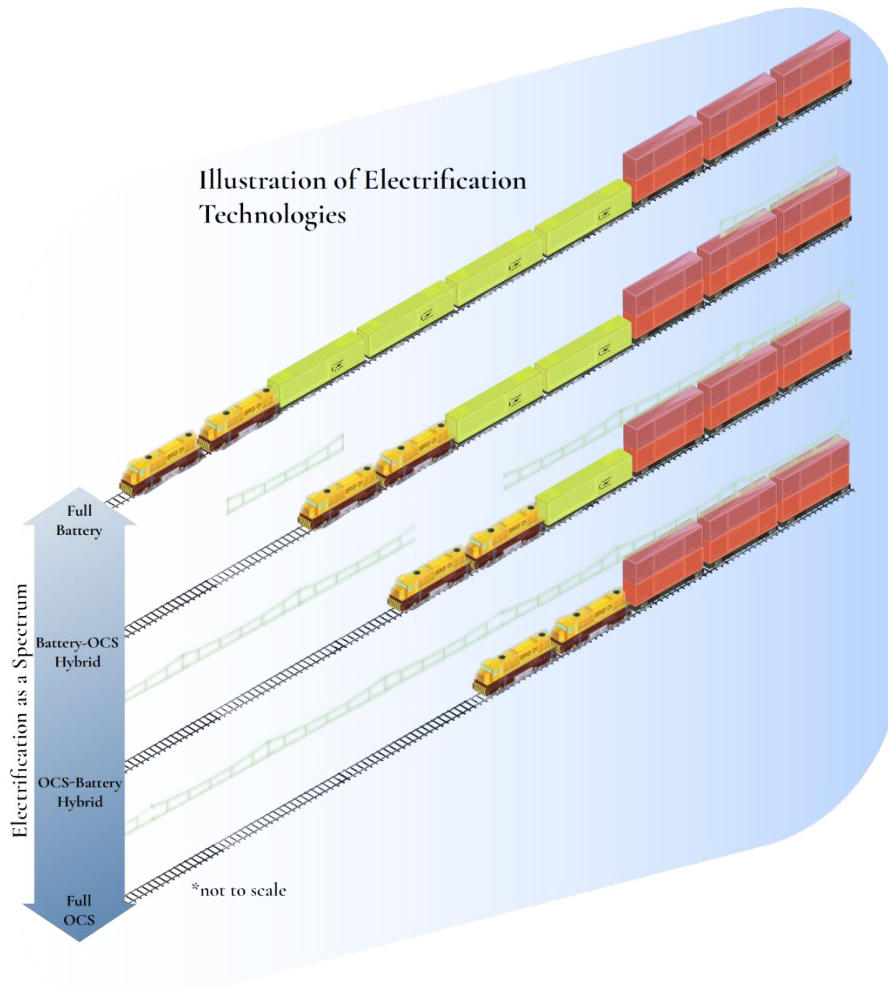

Figure 44. Illustration of the Spectrum of Intermittent Electrification from Fully Battery-powered Electric Trains to Fully OCS-powered Electric Trains

8.2 Technical Challenges

Intermittent electrification faces many of the same technical challenges as DMLs discussed in [Section 7.4.6](#). Without the need to accommodate a diesel prime mover within the locomotive or any fuel tank, there is a large weight budget to fit electrical components onboard the locomotive. The remainder of this weight budget can be padded by battery storage capacity. To achieve reasonable range outside of OCS territories, the low energy density of batteries will likely require the locomotive to interface with one or more battery tenders.

The overall cost for these locomotives remains uncertain. While electric locomotives generally provide long-term savings on maintenance, there is uncertainty over how often the expensive batteries for these locomotive systems will need to be replaced, introducing an additional unknown into the long-term economics of intermittent electrification. Once the industry accrues more operational knowledge, it should be possible to phase the construction of the OCS build-out to avoid some battery replacement costs. For example, suppose a given set of battery tenders

is sufficient to provide revenue service along a corridor for fifteen years. Those battery tenders would not need to be replaced at the end of their service life if, over that fifteen-year period, enough OCS has been built across that corridor such that the tenders' reduced capacity can still bridge the smaller OCS gaps.

8.2.1 Locomotive Capabilities

As described earlier, it should be feasible to design or convert a locomotive for intermittent electrification operations with a similar tractive effort and power to existing AC diesel-electric freight locomotives. Where OCS segments remain sparse, the need for battery tenders will reduce the amount of revenue tonnage available to each train.

8.2.2 Project Mobilization Uncertainty

Because intermittent electrification is relatively new, there is little experience in how much the cost of building short segments of OCS will rise due to the need to move equipment and crews to different sites along the corridor rather than continuing construction linearly along the corridor. Along certain corridors, this effect can be mitigated to some extent. As discussed in [Section 6.2.4](#), Weiss et al (1983) noted a rise in unit OCS construction costs along active rail lines due to traffic disruptions and restricted work windows. If intermittent electrification takes advantage of segments with parallel tracks, the overall schedule disruption during construction can be reduced. This would carry the downside of requiring trains that need to utilize the OCS (e.g., if they would have insufficient charge to reach the next OCS segment) to be restricted to one track. This restriction could lead to future delays, and the corridor's long-term operational needs will need to be balanced against any short-term construction savings.

8.3 Potential Economic Advantages

Besides reducing the total length of installed OCS and its associated infrastructure investment, intermittent electrification offers other potential economic advantages arising from avoiding clearance issues and changing the timing of project costs and benefits.

8.3.1 Clearance Advantages

[Section 6.1.4](#) discusses some of the infrastructure costs that an electrification project can accrue due to OCS clearance restrictions. As discussed in that section, there are some techniques available to reduce the amount of clearance required to accommodate an OCS. With intermittent electrification, segments with the most expensive necessary interventions, such as the four bridges that would have required reconstruction in [Table 9](#), could be traversed by battery, avoiding the issue entirely.

Beechey & McKlerie noted in a Scottish Borders Railway passenger study that intermittent electrification could reduce the total capital cost for electrifying a 52.2 km (32.4 mile) segment from \$274 million to \$93 million, a 66 percent reduction (2021). Because the project was able to avoid segments with tunnels or low bridge clearances, and those segments are correlated with the type of terrain that increases project construction difficulties, even the unit cost of the OCS segments in the study fell by 7 percent compared to the unit cost of OCS for full electrification of the corridor.

8.3.2 Moving Electrification Cost and Benefit Flows Forward

Like DML adoption, intermittent electrification allows for the accrual of benefits for an electrification project before the entire OCS network is built-out. As seen in Figure 45, a simulation of the full electrification of the BNSF TransCon route from Los Angeles, CA, to Chicago, IL, showed the internal rate of return for the full electrification project rose from 7 percent when no segments could see electrified operations until full construction was complete, to 12.9 percent when every segment could begin electrified operations once construction of that segment was complete (Walthall, 2019, pp. 93-94). This analysis shows the potential for intermittent electrification to improve the economic performance of rail electrification projects, even if the eventual goal of the project is full corridor electrification.

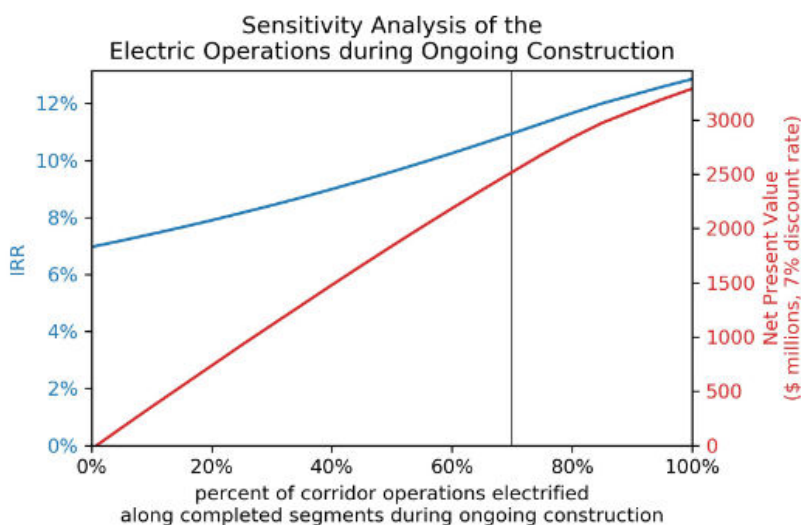

Figure 45. Sensitivity Analysis of Electric Operations During the Ongoing Construction Period for a Simulated Electrification of the BNSF TransCon

8.3.3 Mitigating Network Effects

Related to the effect of moving project benefits forward, the battery capability of trains in intermittent electrification allows freight trains to traverse un-electrified yards or sidings. This means that fully decarbonized freight could reach far-flung areas of the rail network with OCS construction only along mainlines. This would eliminate one of the historical problems with electrification projects, which was the need to electrify the entire network, including segments that did not have traffic densities to support electrification on their own, or introduce negative network operation impacts through the cost and delay of frequent locomotive exchanges.

9. Implementation Strategies

In addition to altering electrification infrastructure and its associated motive power, the key economic barriers to freight rail electrification can also be addressed by pursuing different implementation strategies. Building off previous studies, this section introduces potential partnerships with the public and utilities.

9.1 Private-public Partnerships to Capture Social Benefits of Electrification

While railroads are private companies, their commodity flows are an essential part of the North American economy, and locomotive emissions contribute measurable amounts to social costs such as climate change and public health. Incentivizing railroads to electrify would provide public benefits in these two areas. To the extent that rail electrification could induce a freight mode shift from trucking to rail, these benefits could be increased. This section discusses the fundamental measures behind rail's social costs, and the structure of a potential public-private partnership to incentivize rail electrification.

9.1.1 Monetizing Emissions Reductions

The foundation of a private-public partnership for railway electrification is to provide a mechanism to capture the value of social (i.e., climate and health) benefits of locomotive emissions reductions, and transfer that value to railroads to help offset the costs of electrification. To evaluate the viability of these benefits to support overall costs, the social benefits of the emissions reductions obtained via freight rail electrification must be monetized.

9.1.2 Estimating Emissions Benefits from Electrification

Estimating the emissions benefits of electrification requires the establishment of an initial baseline of diesel-electric locomotives as a basis for calculating the change in emissions produced by other electrification options. Calculating the actual change in emissions for each electrified train depends on the route, the source of the electricity, and the type of locomotive being replaced. For example, replacing a Tier 4 locomotive provides fewer benefits than replacing a Tier 3 locomotive.

To calculate this baseline, [Table 27](#) shows the cost per tonne for oxides of nitrogen (NO_x), oxides of sulfur (SO_x), fine particulate matter (PM_{2.5}), and carbon dioxide (CO₂) that are all by-products of the combustion of diesel fuel (US Department of Transportation, 2023).

Table 27. 2024 Damage Costs for Emissions Per Tonne from the US DOT Cost-benefit Analysis Guidance

NO _x	SO _x	PM _{2.5}	CO ₂
\$20,100	\$53,800	\$963,200	\$233

While [Table 27](#) provides accepted average values, pollutants that degrade public health like NO_x (which contributes to ground-level ozone), SO_x (which contributes to smog), and PM_{2.5} (which contributes to cancer, asthma, and other maladies) have greater impacts when they are emitted near urban areas. This means that the value for reducing those emissions might be much higher when electrifying older locomotives within switching yards next to urban communities, and lowest when replacing Tier 4 line-haul locomotives primarily operating in rural settings. CO₂ is a

greenhouse gas, and the value of abating CO₂ emissions does not depend on the location of the emissions. Likewise, while the other three pollutants in Table 27 are byproducts of the diesel combustion process, CO₂ is one of the primary products, so its emissions are directly tied to the amount of diesel combusted. This means that, while a higher tier locomotive will produce much lower emissions of NO_x, SO_x, and PM_{2.5}, it will only produce lower CO₂ emissions to the extent that it is more fuel efficient – while higher tier locomotives do tend to be more fuel efficient, this marginal improvement is small relative to pollutant reductions.

Table 28 shows the EPA’s emissions standards for various locomotive tiers (US Environmental Protection Agency, 2009, p. 2). Note that these standards enforce PM₁₀, rather than PM_{2.5}, and carbon monoxide (CO) rather than CO₂. The EPA notes that nearly all locomotive particulate emissions are smaller than 2.5 microns, and recommends that total particulate emissions be multiplied by a factor of 0.97 to arrive at PM_{2.5} emissions (US Environmental Protection Agency, 2009, p. 4). The EPA also notes that CO₂ and SO_x emissions depend primarily on the fuel rather than the engine itself. In example calculations, the EPA reports 1.88 grams sulfur dioxide (SO₂) per gallon of diesel combusted (with SO₂ constituting nearly all the SO_x emissions by volume) and 10,217 grams CO₂ per gallon of diesel combusted.

Table 28. EPA Line-haul Emission Factors (g/bhp-hr)

Locomotive Type	PM ₁₀	HC	NO _x	CO
Uncontrolled	0.32	0.48	13.00	1.28
Tier 0	0.32	0.48	8.60	1.28
Tier 0+	0.20	0.30	7.20	1.28
Tier 1	0.32	0.47	6.70	1.28
Tier 1+	0.20	0.29	6.70	1.28
Tier 2	0.18	0.26	4.95	1.28
Tier 2+ & Tier 3	0.08	0.13	4.95	1.28
Tier 4	0.015	0.04	1.00	1.28

Table 29 provides a rough estimate of the overall social cost of operating a 3,300 kW (4,400 hp) locomotive at full power (throttle notch 8) for one hour. As expected, the higher-polluting lower emissions tier locomotives bear a higher social cost of emissions. Because the EPA tiers were created with the intention of reducing health-degrading pollutants rather than greenhouse gas emissions, locomotive CO₂ emissions, compared to other pollutants, are relatively consistent for the various tiers.¹⁶ For lower-tier locomotives, most of the social costs of emissions come from particulate matter, while for Tier 3 and Tier 4 emissions, most of the social costs come from CO₂. These social costs help to show the magnitude of public benefits that can accrue from rail electrification. However, railroads, as private companies, would not factor these benefits into their business decisions without some method to internalize these benefits.

¹⁶ While Table 29 presents the same social cost for CO₂ for all locomotive types, this is not strictly accurate. Generally, newer locomotives are more fuel efficient, and thus produce less CO₂, until Tier 4. The lowest CO₂ cost would belong to Tier 3 locomotives. The scrubbers in Tier 4 locomotives that reduce other emissions causes them to lose efficiency and produce more CO₂ for a given amount of work.

Table 29. Estimated Social Cost of Emissions for One Hour of Locomotive Operations at Maximum Power, 3300 kW (4400 hp)

Locomotive	NO _x	HC	PM _{2.5}	CO ₂	Total
Tier 0	\$28	\$20	\$1320	\$552	\$1920
Tier 1	\$28	\$19	\$1320		\$1920
Tier 2	\$16	\$11	\$740		\$1320
Tier 3	\$5	\$5	\$329		\$894
Tier 4	\$1	\$2	\$62		\$617

9.1.3 Estimating Electric Locomotive Emissions

While electric locomotives eliminate mobile-source emissions, their overall emissions are a function of how the electricity they consume is produced. Figure 46 shows the intensity of CO₂ emissions (in lb CO₂ per MWh) across the various electrical grid subregions across the US (Federal Railroad Administration, 2023). Parts of the Midwest have emissions intensities nearly seven times as high as the lowest-intensity parts of the grid in upstate New York. Correspondingly, electric locomotives emissions and benefits will exhibit considerable geographic variability.

Other pollutants show similar variance across the country (Federal Railroad Administration, 2023). It is possible to use this data on regional grid emission intensity to calculate the actual emissions of an electric locomotive along a particular corridor.

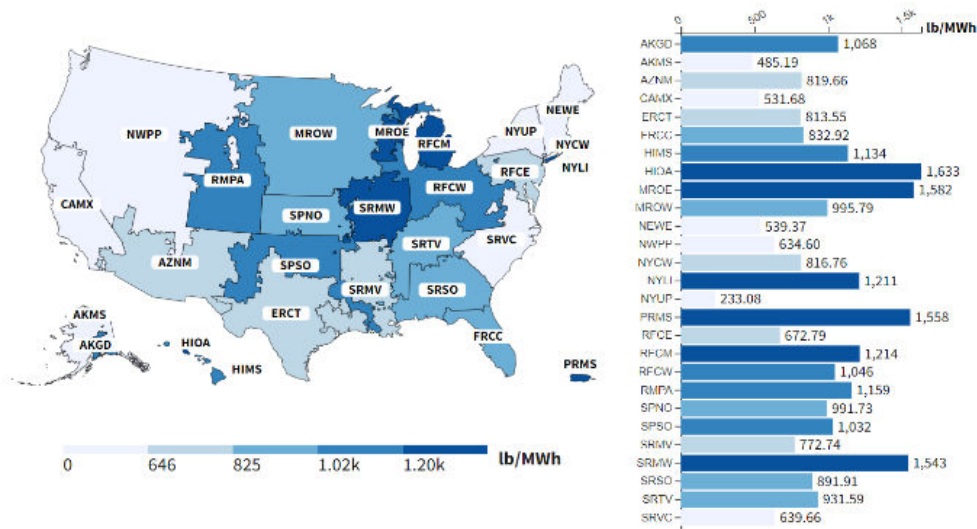

Figure 46. Map of Regional Grid Electricity CO₂ Intensity Across the US from FRA's Locomotive Emissions Comparison Tool (LECT)

9.1.4 Mechanism for Internalizing Public Benefits

Internalizing benefits could take various forms. A straightforward method would be federal grants to the private rail companies for the purpose of constructing electrification projects and acquiring equipment. Such grants could be linked with the expected social benefits tied to emissions reductions related to electrification. A more direct form of public-private partnership would be for public construction of OCS, which would then be leased to the railroads using it.

Such an agreement was considered in the 1980s, and would have been made possible through Title V of the 4R Act, either through the government purchase of railroad preferred shares, or through guaranteed low-interest loans (Harrison, 1981).

Conversely, a public policy such as a carbon tax would incentivize railroads to electrify to reduce their tax burden.

9.1.5 Risk Mitigation

While direct public subsidy or Pigouvian taxation¹⁷ would require significant political capital, public-private partnerships could also take forms that involve fewer direct transfers. A public-private partnership could be formulated such that some of the risks of electrification, such as high future electricity costs, would be shifted to the government. This action could spur private investment by increasing the expected ROI. A large public expense would only come about in the case of larger than expected future electricity prices in this example.

9.2 Right-of-Way Sharing Agreements with Electric Utility Providers

In appraising utility easements along railroad ROW, the various parties often find themselves in disagreement over the validity of different rents charged for use of one another's easements. Due to the nature of overlapping railroad company and utility company services, utility companies are the largest user of railroad ROW easements, although many such easements run at right angles across the ROW. As electric utility companies seek to expand their high-voltage distribution networks to connect rural renewable energy generators (e.g., wind and solar farms) with urban users, they will require significant new ROW, and longitudinal easements along railway lines could become more common.

If these easements are made in conjunction with railroad electrification, both the railroads and the electric utility companies stand to gain. For the railroads:

- Construction of OCS typically involves a significant cost of building distribution lines to connect traction substations with the electricity grid. This would be mitigated if the electrical distribution network were already to be next to the electrified railway.
- A new source of income helps the economics of rail electrification.
- Right-of-way easement deals with utility companies can be structured to reduce the amount of uncertainty railroads see in future electricity prices.

For the electric utility companies:

- Acquiring long stretches of ROW from one entity rather than hundreds of separate property owners greatly reduces the complexity of planning a new high-voltage distribution line. This reduces the risk of delays and the risk of unexpectedly high ROW costs.
- Railroad rights-of-way have already been cleared of foliage and undergone significant environmental review processes.

¹⁷ A Pigouvian tax is a tax on an activity that creates a negative externality, or additional cost, on people who are not directly involved in the activity.

- Assisting freight railroads with electrification provides the utility companies with new industrial customers.

Despite these potential benefits, it is important to keep in mind some potential downsides:

- Building high-voltage transmission lines next to a busy rail corridor could increase construction costs, lead to train delays, or both.
- Derailments risk damaging transmission lines, so transmission lines might need to be built to a higher standard of crash worthiness than when located on non-railroad ROW.

These technical challenges should not prevent an agreement from being possible. [Figure 47](#) and [Figure 48](#) respectively show latitudinal and longitudinal examples of electric transmission lines built near existing multi-track rail lines.

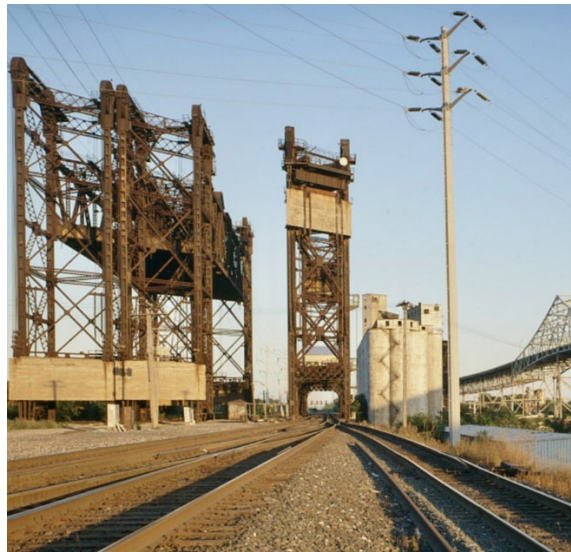

Figure 47. Latitudinal Transmission Line Next to a Norfolk Southern (formerly Conrail) Rail Line Near Lake Calumet in Chicago, IL. Note the Proximity of the Relatively Thin Power Pylon to the Railroad Tracks



Figure 48. Longitudinal Transmission Line Along the Chicago South Shore and South Bend Railroad Parallel to the Indiana Toll Road

9.2.1 Right-of-way Acquisition Background

To discuss the details of a potential deal for ROW sharing agreements, it is necessary to provide some background on how utility companies typically handle ROW acquisition. Two methods are used most often to assess land value (The Appraisal Institute, 2006):

- Comparable sales of adjacent land, also known as across the fence methods
- Market value assumptions of the next highest and best use of the land

Market model changes started to occur in the post-war era of the 1950s to 1980s as various railroads fell under poor financial conditions due to lost freight business, and many went bankrupt. As one example, the Penn Central Railroad was desperate for positive cash flow, so it sold off much of its prime real estate, such as land near the Calumet River of Chicago and the area near 63rd Street.

The perceived land value of railroad ROW is as a unique linear collection of parcels of land where the premium to a secondary (i.e., new) utility user is driven because of the pre-assemblage of these parcels. This pre-assemblage allows the secondary user to avoid the significant cost of acquiring land access from multiple parties when building an all-new corridor. This offers the utility companies the value of both pre-assembly and avoided time delay costs. The critical aspect is that the utilities may seek to lower their assemblage costs and the procurement delay related costs (i.e., time) by using the railroad companies' linear ROW.

However, the across the fence valuation method of assessing land values in a corridor path is often cumbersome – typically the different properties are often of mixed land uses. This occupancy factor or type method often complicates obtaining an appraisal with this methodology, which makes using parallel easement occupancy factors less reliable when trying to estimate a negotiated value.

9.2.2 Notable Exceptions

There are various states (not federal court cases) that look to establish equitable compensation terms by using other secondary corridor-use valuation methods. This method might be inconsistent with the overall regulation of the railroad industry by the Surface Transportation Board.

There are also local state and municipal regulations that specify setbacks and other considerations that would affect the practical use of some across the fence valuation calculations. As an example, Minnesota has a law that often sets a minimum safety clearance of 8.5 feet (2.6 m) from the center line of railway tracks. Thus, in that state, there is a precedent that any land beyond the 17-foot (5.2 m) width of a single-track railroad might be considered a railroad easement and excess ROW. [Figure 49](#) shows a diagram of this excess ROW.

Theoretical width discussion

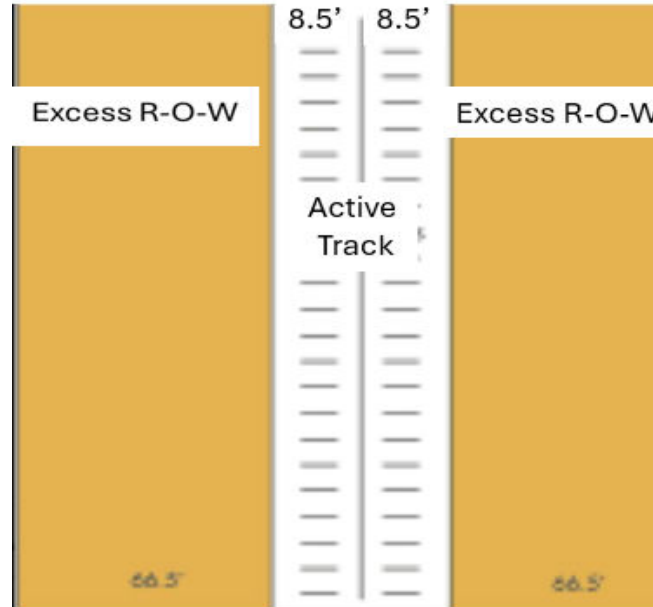

Figure 49. Diagram of the Excess ROW on Either Side of an Active Railroad Track

9.2.3 *Alternate Valuation Methodologies*

With sufficient communication and understanding between the railroad and utility stakeholders, it would, in principle, be possible to reach an agreement upon a simpler method due to the shared nature of the land use, rather than normal ROW acquisition procedures that rely upon a full transfer of land. The current railroad negotiation tactic uses the basic methodology of valuing annual rent based on the across the fence land values, a corridor-specific use factor, and an annual rate of return. Considering the value utility partners would receive would have the potential to create a place from which to start negotiations that would be more likely to reach a final agreement.

Appraisals do not have to be complex if they meet certain criteria:

- The alternate use is physically possible
- The alternate use is legally permissible
- There is an economic business case for the alternate use
- The range of potential profitability for the use case does not impose undue risk
- The cash flow from the alternate use has a reasonable payback period
- The alternate land use does not compromise safety

10. Mapping Possible Solutions to Economic Barriers

Section 6 through Section 9 review various possible infrastructure construction, motive power, and implementation strategy solutions to address the economic, technical, and institutional barriers to freight rail electrification identified in the initial sections of this report. Each solution specifically addresses certain economic barriers, including absolute costs and benefits, scope and timing of benefits, and uncertainty and risk. Table 30 maps specific solutions to each of these critical economic barriers, as described further in subsequent sections.

Table 30. Potential Impact of Identified Infrastructure, Motive Power, and Implementation Solutions on Economic Barriers to Freight Rail Electrification

Solution	Lower Costs	Increase Benefits	Widen Scope of Benefits	Create Initial Benefits	Reduce Uncertainty and Risk
<i>Infrastructure</i>					
Higher voltage	•				
Lower frequency	•				
Autotransformers	•				
Adjustable voltage	•				
Pylon optimization	•				
Bridge clearance alternatives	•				•
OCS construction trains	•			•	
Disruption avoidance	•			•	•
Design-build project delivery	•	•		•	•
Standards and industry maturity	•			•	•
<i>Motive Power</i>					
AC diesel to electric conversion	•				•
DMLs and EPT	•	•		•	•
Dual-mode electric with batteries	•	•		•	•
<i>Infrastructure and Motive Power</i>					
Intermittent electrification	•	•		•	•
<i>Implementation Strategy</i>					
Public-private partnership	•	•	•		•
Utility partnership	•	•	•	•	•

10.1 OCS Infrastructure Solutions

Various OCS design improvements, including higher voltage, lower frequency, autotransformers, adjustable voltage, and pylon optimization, can potentially reduce costs by more appropriately sizing the OCS infrastructure to the specific needs of North American freight rail operations and the clearance constraints of a particular corridor. However, these approaches have little impact on benefits or reducing uncertainty and risk.

Alternatives to raising or reconstructing overhead bridges to address clearance concerns can reduce the cost of electrification via OCS. Avoiding the need to conduct extensive civil construction works to address overhead roadway or railroad bridges also reduces the large

amount of uncertainty and risk associated with the cost and schedule of projects that involve complex coordination with State DOTs and other municipal and local agencies. Alternatives to address clearances can eliminate (depending on the extent of reconstruction otherwise required) extensive landowner coordination and ROW acquisition with their associated uncertainties.

Alternative construction approaches, such as OCS construction trains and long reach equipment to avoid operational disruptions, should lower costs through more efficient construction. A more efficient construction process can also reduce the timeline required to energize and use the OCS, potentially facilitating an increase in initial project benefits. Equipment that does not directly foul the track and require track time to travel to/from sidings and staging tracks can minimize operational disruptions, resulting in greater schedule certainty and less risk.

Design-build project delivery will similarly result in more efficient construction and reduced schedule timelines and lower costs, creating initial benefits and reducing the risk of extensive delays due to redesign after the start of construction. Alternative project delivery methods should also increase project benefits by optimizing the design of the infrastructure and motive power together as a system to maximize efficiency and operational performance.

As reflected by the substantial reductions noted in an international study (Railway Industry Association, 2019), the most impactful infrastructure solution is likely to be standards, guidelines, and best practices for North American freight rail OCS design that will only come with increased frequency of electrification projects and the maturity of a freight rail electrification design, supply, and construction industry.

10.2 Motive Power Solutions

Compared to developing new custom electric locomotive designs, the cost of freight rail electrification is likely to be lowered by converting existing AC-traction diesel-electric locomotives to straight electrics, DMLs with EPTs, or dual-mode electric locomotives with batteries. In addition to reducing costs by reusing the locomotive platform and many key components such as the cab, trucks, and traction drive, locomotive conversion reduces the uncertainty and risk associated with the cost of new electric locomotive designs that do not yet exist.

In addition to costs and risk, both dual-mode options address the economic barriers of increasing benefits and creating initial benefits. Dual-mode operations will allow trains that only use part of an OCS-equipped corridor to use electric power where available instead of continuing to use diesel under the OCS to avoid a locomotive exchange. Allowing additional trains to use the OCS will increase the total benefits of the electrification project. Further, because they can use individual OCS segments as they are constructed and energized while making use of diesel or batteries elsewhere, dual-mode motive power solutions create initial project benefits that are not accrued with traditional electrification approaches that require completely constructing corridor-length OCS before electrified operations can begin.

10.3 Intermittent Electrification and Implementation Strategy Solutions

The combined infrastructure and motive power solution of intermittent electrification reduces costs by requiring less OCS to be constructed, increases benefits by allowing more trains to make use of the OCS, creates initial benefits by using OCS segments as they become energized, and eliminates the uncertainty and risk associated with civil construction works by strategically

locating gaps where such work would otherwise be required. Although intermittent electrification could benefit from design and component advances because it addresses four major economic barriers, implementing an intermittent electrification strategy is likely to be more impactful than specific infrastructure component design improvements for traditional OCS. Intermittent electrification is also necessary to fully leverage the most promising motive power solutions, and thus is an important focus of the economic analysis framework and case studies presented in subsequent chapters.

Both implementation strategies are the only solutions discussed in this report that increase the overall scope to include other types of benefits beyond the energy costs and locomotive maintenance benefits historically assigned to freight rail electrification projects. Public-private partnerships provide a potential mechanism for capturing the monetized social (i.e., climate and health) value of reductions in emissions due to freight rail electrification. Utility partnerships extract value from the linear nature of railroad ROW as a pre-assembled corridor that can help streamline the construction of electrical transmission lines that are urgently needed to connect renewable generation projects with growing centers of demand. Both options also reduce railroad costs and risk by shifting some of the initial electrification infrastructure investment and associated risk to non-railroad funding sources. Utility partnerships also have the potential to reduce costs through negotiated discounts on railroad electricity rates as compensation for co-location within the ROW. Finally, utility partnerships can help create initial benefits because co-location may speed the construction of transmission connections between the grid and substations feeding the OCS, allowing it to be energized and begin accruing energy and emissions savings earlier in the project. Because of these potentially substantial impacts across multiple economic barriers, these implementation strategy solutions also form a key component of the economic analysis framework and case studies presented in subsequent sections.

11. Costs, Uncertainties, and Risks of Rail Electrification with New Technologies (CURRENT) Model

This section discusses the three components of the Costs, Uncertainties, & Risks of Rail Electrification with New Technologies (CURRENT) Model developed in this project. The CURRENT Model provides a flexible framework to analyze the efficacy of different electrification technologies along a given rail corridor. While the costs of many of the technologies discussed within this report remain uncertain, the CURRENT framework was built from the ground up to be able to incorporate uncertainty into the analysis of rail electrification and incorporate better cost estimates as the industry gains experience with decarbonization techniques.

The CURRENT Model has three primary components, which are designed to work together sequentially. The train performance function, which was developed in Python, allows for the estimation of the energy consumption of different rail technologies along the corridor of analysis. Those energy consumption estimates are incorporated into the economic cost-benefit analysis toolkit, which estimates the project’s overall effects from the perspective of the private rail company and the public perspective. This estimation is performed in Microsoft Excel, and includes estimates of capital costs, maintenance costs, taxes, energy costs, emissions, and ROW sharing effects. The final piece of the model performs a Monte Carlo simulation of the economic analysis using a plugin for Microsoft Excel called Argo, which was developed by Boozé Allen. Figure 50 provides a convenient illustration of how these three model components connect.



Figure 50. Illustration of How the Three Primary Components of the CURRENT Model Connect to One Another

By using the CURRENT Model, it is possible to quickly estimate how different technologies for rail electrification would perform along a particular rail corridor. As the case studies in subsequent sections will show, the traffic patterns, train types, and topography along a corridor all affect which technology will provide the best economic performance for rail electrification.

The rest of this section describes the individual components of the CURRENT Model. A separate user manual provides detailed instructions on how to use the CURRENT Model and interpret its results (available by request). The case studies in the following two sections also provide several examples of how the CURRENT Model can be used to analyze several rail electrification technologies for two different freight rail corridors.

11.1 Train Performance Function

The train performance function was developed within Python, and estimates energy consumption using a Uniform Rigid Mass Strap model. The model ignores internal train forces, treating the train rigidly with fixed car spacing. The model uses information about the route’s grade, curvature, and speed restrictions to simulate a train traversing the corridor.

11.1.1 Mass Strap Train Simulation Model

Based on the position of the front of the train, the model calculates the position of each subsequent rail vehicle along the consist and calculates the external forces acting on each section of the train. It then combines those forces, determines the train's current desired speed, and adjusts the throttle position or brake application of the train's locomotives and brake systems based on the difference between the train's current speed and its desired speed.

The model accounts for the following forces acting on each railcar:

- rolling resistance
- flange resistance
- air resistance
- gravity (i.e., grade resistance)
- curve resistance

The rolling resistance, flange resistance, and air resistance are calculated according to the Canadian National train resistance equations developed in 1992, although it can also use the Davis Equation or Modified Davis Equation. Once the forces are calculated, the model then iterates based on an adjustable timestep (one second by default) to update the train's position and recalculate.

11.1.2 Energy Calculations

For each time step, the model tracks the train's energy consumption (electricity draw or electricity return for electric trains; battery state-of-charge for battery trains; and diesel for diesel-electric trains). The overall energy consumption is based on the required energy output for the train's calculated motion, and then adjusted based on the efficiency of each internal process within the locomotives to arrive at the necessary energy input. Figure 51 shows an example of this calculation.

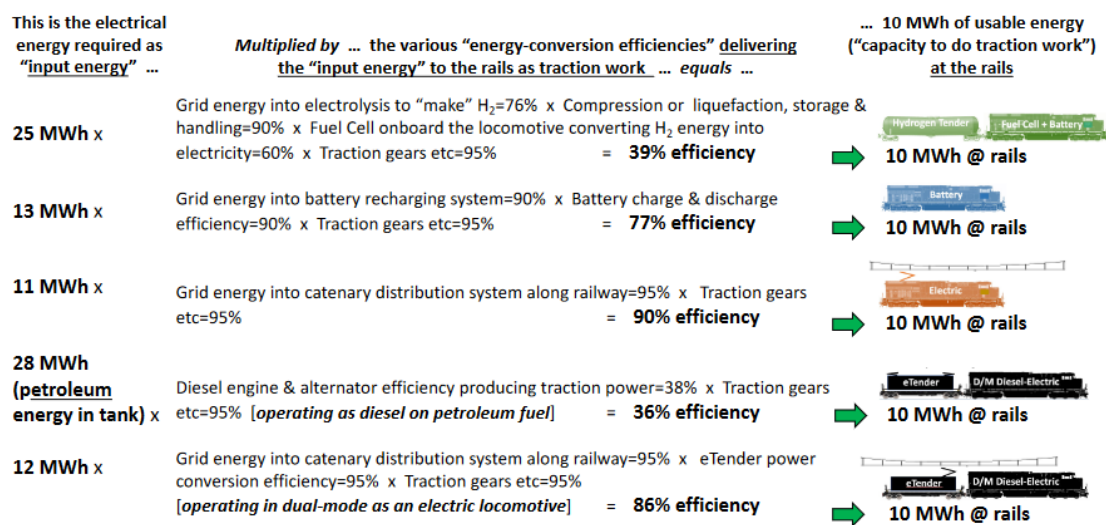

Figure 51. Example Calculations of the Thermal Efficiency of Different Locomotive Technologies

Note that for certain processes within the model, the train's state itself will affect the efficiency of some of these steps. For example, the efficiency of the prime mover in a diesel-electric locomotive varies at different throttle positions; generally, prime movers are designed to provide optimal efficiency near maximum power output measured by the engine's brake-specific fuel consumption (BSFC), and the model accounts for this.

The model uses a similar process to calculate how much energy is returned via regenerative braking, applying different efficiency losses to the energy returning to the OCS or to onboard batteries.

11.1.3 Alternatives to the Train Performance Function

The inclusion of the train performance function allows for estimating the energy consumption of diesel-electric, battery-electric, or conventional electric trains along a corridor with a wide array of railcars and adjustable locomotive parameters. The CURRENT Model's economic component requires energy consumption estimates, but it is easy to input those estimates from separate sources, such as alternate train performance models or measurements taken from actual trains operating along the corridor, if available.

11.2 Economic Model

The core of the CURRENT Model is the economic toolkit it provides. This toolkit estimates the costs and benefits of electrifying a given rail corridor based on over 70 adjustable parameters. It then estimates the net present value of the project according to three discount rates: 3 percent, 7 percent, and a third set by the user. It also calculates the project's cost-benefit ratio based on the same discount rates. Finally, the toolkit calculates the project's internal rate of return, which is the discount rate at which the net present value would be zero. The CURRENT Model calculates each of those outputs based on four perspectives:

- **Purely private perspective**, examining what the investment would look like if a private railroad company pursued electrification of a corridor on its own
- **Private investment with ROW sharing**, examining the private railroad's investment when the electrification is pursued in partnership with an electric utility company
- **Private investment with ROW sharing and public support**, examining the private railroad's perspective when, in addition to a partnership with an electric utility company, some amount of public funding tied to the public benefit is made available for the project
- **Public perspective**, examining the investment's total social costs and social benefits

CURRENT calculates the net present value of a total of 15 different benefit or cost categories. Based on the perspective in question, these categories are either included or excluded to generate the final net present value, cost-benefit ratio, and internal rate of return calculations. The following subsections describe important components of those cost categories.

11.2.1 Capital Construction Costs

Capital construction costs primarily account for the cost of OCS to support the project. This could include OCS along the entire corridor for conventional electrification, or OCS along certain segments of the corridor for various forms of conventional electrification.

The model has parameters for the various costs associated with OCS construction, including catenary, substation, transmission, public works, and signaling and communication. For the route under analysis, the user specifies which segments will have OCS constructed, the relevant public works, substation, and signal insulation locations, and the order of priority for various segments. Separate parameters control how long the construction will take to complete, and CURRENT assigns the construction costs over the initial years of the project. If the user specifies that some electric operations are possible before construction is fully complete, the model determines when specific segments will become electrified.

CURRENT assumes that OCS construction determines the project management’s critical path, meaning that public works and signaling and communication work take less time than installing the pylons and running the catenary cables.

On the Capital Cost Summary page, CURRENT reports the average OCS cost for the project per km and provides a graphical display of the capital construction cost outlays by year. Figure 52 shows an example of this graphical display for the construction of OCS along a 1000 km hypothetical rail corridor.

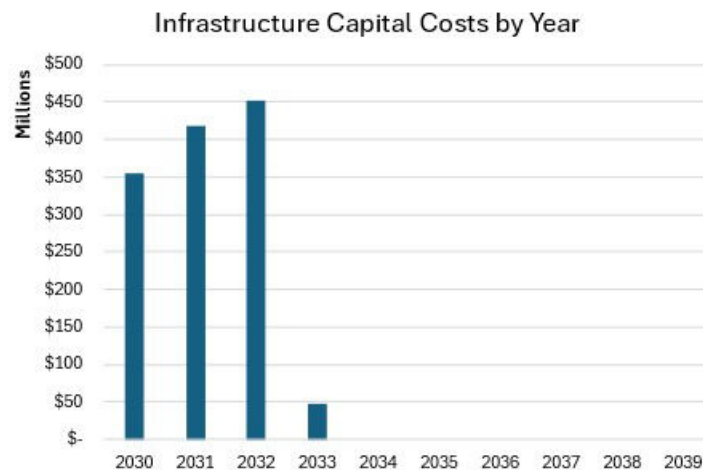

Figure 52. An Example of CURRENT’s Capital Construction Costs by Year

The capital construction cost category does not include the cost of constructing new maintenance facilities, nor does it include the cost of fixed battery charging equipment, such as fast chargers at rail yards. Those costs can be included within the [Facilities & Training Section \(11.2.15\)](#).

Capital construction costs are assigned to the project costs of all perspectives.

11.2.2 Equipment Procurement Costs

Equipment procurement costs primarily account for the cost of electric or battery locomotives, as well as the project’s necessary support tenders.

CURRENT has parameters for each of the respective equipment types. Depending on the nature of the project being analyzed, some of these costs should be adjusted from their default values. For example, the Electric Locomotive cost would be higher than the default value if the project involves battery electric locomotives rather than conventional electric locomotives, while the

cost would be lower than the default value if the project involves reconstructing diesel-electric locomotives rather than procuring new electric locomotives.

The user can set the average lifespan for equipment used along the corridor, which is set to 30 years by default for all equipment types other than battery tenders. CURRENT calculates the equipment procurement costs for the years in which equipment is first procured, and then assigns equipment replacement to future years based on the average equipment lifespan. The user inputs allow CURRENT to estimate how many diesel-electric locomotives would be acquired for the corridor within the base case, and the model assumes that electric or DMLs acquired for the scenario would defer diesel-electric locomotive replacement. This means that this category will tend to generate a net cost during the years when new equipment is acquired for the project or when equipment is replaced, but this category might produce a net savings for years in which diesel-electric locomotives would have been but are no longer required.

For DMLs, the default assumption is that the DMLs in use will use EPTs for the electrical equipment and retain most of the diesel-electric capabilities onboard. The default costs should be adjusted for alternate dual-mode configurations.

Equipment Procurement costs are considered a project cost for all perspectives. For years in which the equipment procurement cost is negative due to diesel-electric locomotives that no longer need to be replaced, this counts as a reduction to the overall project cost rather than a project benefit.

11.2.3 Maintenance of Rolling Stock

Maintenance of Rolling Stock is based on the types of rolling stock that are in use for each project year and the amount of travel accrued. CURRENT has parameters for the maintenance cost rates of electric, diesel-electric, and DMLs, as well as tenders. In general, electric locomotives have lower maintenance rates than diesel-electric locomotives. Regardless of whether the net maintenance is positive or negative, this category counts as a project benefit from all perspectives because equipment maintenance is a flexible project cost based on equipment use.

11.2.4 Maintenance of Way

The Maintenance of Way category accounts for the change in maintenance of way costs due to any new OCS involved in the project under analysis. This category is based on the segments of OCS constructed, and begins to accrue once each segment is complete. This category counts as a project cost for all perspectives because the maintenance of way becomes a fixed cost that must be paid due to the project being built.

11.2.5 Diesel Savings

The diesel savings category accounts for the difference in diesel expenses between the project and the base case. CURRENT calculates the diesel cost for each year of the analysis based on the calculated diesel consumption, the diesel cost parameter, and the diesel cost growth factor parameter. The diesel cost growth factor determines the simulation's annual rate for the real cost of diesel. Because this is a real cost, it is a measurement of the growth of diesel outside of inflation. In general, any type of electrification analysis should lead to a net reduction in diesel

Based on the changes in diesel-related emissions and electricity-related emissions, CURRENT calculates the net change in CO₂ emissions. The model then uses the value of carbon from the US DOT cost benefit analysis guidance (2023). The department guidance provides a valuation for carbon mitigation per unit mass by year through 2053 (CURRENT extrapolates those valuations for years beyond 2053). Figure 54 shows a sample output of CURRENT’s net CO₂ calculations. In this example, the increase in CO₂ from electricity (the orange line) is more than mitigated by the reduction in CO₂ from diesel-electric locomotive operations (the green line), resulting in the net reduction shown by the blue line.

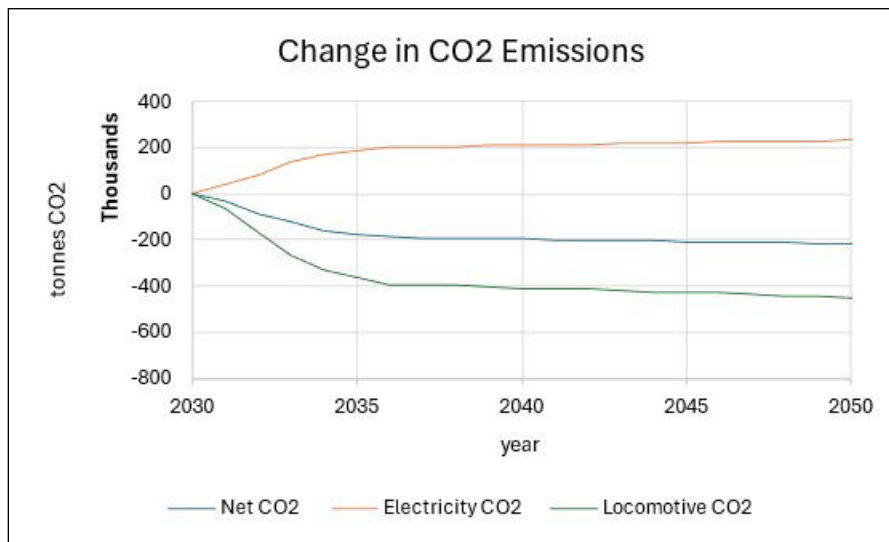

Figure 54. Sample Output of Net CO₂ Emissions from CURRENT

Reducing climate emissions counts as a benefit from the public perspective, and is excluded from the purely private perspective of private investment with ROW sharing. For the private perspective with public support, CURRENT has an adjustable parameter to set the percentage of the overall climate emissions that benefits can be internalized to the private railroad through relevant policies. For the specific policy of a carbon tax, this should not be accounted for in this way, as CURRENT has a specific method of accounting for a carbon tax, outlined in Section 11.2.13 below. This perspective can be helpful for examining what level of public subsidy might be necessary to make electrification along the corridor of analysis an attractive investment for the railroad.

11.2.8 Health Emissions

Health emissions are calculated through the same general methodology as climate emissions. For health emissions, CURRENT calculates the net change in NO_x, SO_x, and PM_{2.5} and applies the respective valuations from the USDOT Guidance (2023).

Like climate emissions, health emissions changes count as a public benefit but not a private benefit.

11.2.9 ROW Sharing Electricity Savings

ROW sharing electricity savings is the first of three categories used to keep track of the effects of a potential partnership between the private railroad and an electric utility company. CURRENT

uses this category to track savings the railroad would receive if the partnership agreement allows the railroad to receive electricity and below-market rates. The discounted rate is one of the parameters that the user can set.

All ROW sharing categories are excluded from the purely private benefits, which does not presume any ROW sharing. Likewise, because these payments constitute a transfer from the utility companies to the railroad, none of the ROW sharing categories affect the public perspective – within the public perspective any payment from the utility company to the railroad would be a railroad benefit offset by a utility company cost. While ROW sharing does offer real benefits to the public, primarily in the form of improved economic efficiency, CURRENT does not attempt to measure those effects. Within the two perspectives that explicitly include ROW sharing, ROW Sharing Electricity Savings counts as a project benefit.

11.2.10 ROW Sharing Transmission Savings

Like electricity savings from ROW sharing, the transmission savings category allows CURRENT to account for situations in which the sharing agreement between the utility company and the railroad involves the utility company paying for some or all transmission costs to connect the OCS substations with the electrical grid. A parameter called Transmission Cost with ROW Sharing controls how much of the transmission costs the railroad pays within the agreement. Setting this parameter to zero, for example, would simulate a situation where the utility company is building the project's transmission lines at its own expense. Note that high-voltage transmission lines that the utility company builds along the railroad ROW are not the same as the transmission lines that provide power to the OCS substations.

As with all the ROW sharing categories, this category only counts within the 'Private investment with ROW sharing' and 'Private investment with ROW sharing and public support' perspectives. [Section 11.2.9](#) discusses how these categories count. Unlike the other ROW sharing categories, transmission savings constitute a reduction in project costs rather than a project benefit.

11.2.11 ROW Sharing Lease Income

The ROW sharing lease income category represents direct annual lease payments that the railroad receives as part of the agreement with the utility company for use of the railroad ROW. Parameters within CURRENT control how large these payments are per unit distance and how many years after the start of the project these payments begin.

11.2.12 Annual Property Taxes

Ad valorem taxes¹⁸ have historically motivated railroads to reduce their overall property value. CURRENT attempts to account for the additional property tax burden for which the private railroad will be responsible by keeping track of the total value of new capital construction involved in the project. A parameter within the model controls the property tax rate the railroad pays on these assets. This parameter can be set to the average property tax rate that the railroad pays, or a more specific local rate for the project if this rate is available.

¹⁸ An ad valorem tax is a tax based on the assessed value of an item such as real estate or personal property.

Ad valorem taxes count as a project cost for all three of the private perspectives. For the public perspective, all tax categories count as transfers between the private railroad company and the public, meaning that any public benefit of the tax is offset by the private cost. Therefore, taxes are excluded from the public perspective.

11.2.13 Carbon Tax Savings

CURRENT has the capacity to model a carbon tax intended to reduce CO₂ emissions. By default, the parameter that controls the carbon tax rate (assessed per unit tonne emitted) is set to zero so that the effect of a carbon tax is only included if this is a policy of interest to the user. When the carbon tax is applied, its net effect is calculated based on the project's net climate emissions.

As a Pigouvian tax, carbon taxes are designed to internalize the negative externalities associated with climate emissions. The assessed value of the carbon tax is reduced when CO₂ emissions are reduced, which means that most electrification projects will tend to have positive carbon tax savings. This savings constitutes a project benefit from the private perspective, as the project allows the private railroad to reduce its tax burden. Like other taxes, the carbon tax is not a project benefit from the public perspective, because it is a transfer from one entity (the railroad) to another (the public). From the public perspective, any CO₂ reduction resulting from the project is a public benefit, but the tax revenue itself would be double counted if it were included, due to its nature as a transfer.

11.2.14 Corporate Tax

CURRENT attempts to calculate the electrification project's overall effect on the railroad's profits each year. For years with large capital outlays, the overall profit should decrease, which would correspond to a lower corporate tax burden. For years in which the project brings about savings for the railroad, overall profits should increase and the corporate tax burden should rise. CURRENT is not an accounting model, and makes no assumptions about whether any expenses can be written off. Instead, CURRENT has a parameter to set the effective corporate tax rate for the railroad, which is then applied to the calculated change in profits to calculate, year on year, how much the project will reduce or increase the company's corporate tax burden.

Like other taxes, the corporate tax is a transfer, and therefore only affects the private perspective. Realistically, the corporate tax should be treated as a reduction in project costs if the capital outlays allow the railroad to reduce its corporate tax burden in a year, and a reduction in project benefits for years in which the savings from the project allow the railroad to increase profits. Practically, CURRENT does not differentiate where the estimated net change in corporate taxes originate once it is calculated, and applies all changes to the project benefits.

11.2.15 Facilities and Training

CURRENT does not have a complex cost model to calculate the cost of new maintenance facilities, charging facilities, or workforce training, but it does include a way to include these costs if the user has an estimate of their magnitude. These expenses count toward the project's costs from all perspectives, and user parameters determine over how many years the capital costs for new facilities and the cost of new workforce training should be spread. For the economic model, the user should attempt to apply only the expense that is relevant for the project being analyzed. For example, if the railroad is considering the construction of a new maintenance facility to accommodate the maintenance of electric locomotives traveling along several

corridors, only a portion of that facility's cost would be relevant for the analysis of a specific corridor. In this example, if the facility will support two corridors with equal amounts of traffic, half of the cost of the facility should be included within the analysis of both corridors, and if the railroad determines that one corridor should not be electrified based on the economics, a good approach would be to re-run the analysis of the other corridor with the cost of the smaller facility necessary to support only that corridor. Likewise, the user should consider whether charging facilities would support just the corridor in question, or if the charging facility would support multiple corridors.

Research and development of new technologies is an additional significant upfront cost that could affect electrification projects. The way that CURRENT accounts for facilities or workforce training costs would allow research and development costs to be applied within those categories, with the same caution that only a portion of the research and development costs should be applied to the project if the user anticipates that the research and development costs will support additional projects as well.

For example, consider a project that will involve the procurement of 100 electric locomotives. The user calculates that the long-term cost of these locomotives will be \$4 million per unit, but that it will cost \$40 million to design the locomotive. Within the CURRENT Model, researchers recommend setting the electric locomotive cost in this example to \$4 million rather than \$4.4 million. The \$40 million research and development cost could be included within the facilities or workforce development upfront categories, and if the user anticipates that another 100 of the same type of locomotive will be ordered to support the electrification of an additional corridor, only \$20 million of that research and development cost should be included within the analysis of this project. This will ensure that CURRENT uses the lower cost when those locomotives need to be replaced in future project years.

11.3 Risk Analysis Framework

The last component of the CURRENT model is the Risk Analysis Framework, which performs a Monte Carlo simulation of the economic model. The Monte Carlo simulation recalculates the economic simulation with random parameter values drawn from user-defined distributions to create a distribution of the final economic results. CURRENT was designed to be compatible with the Microsoft Excel plugin Argo (Booze Allen Hamilton, 2016) to run the Monte Carlo simulations. CURRENT uses Argo to perform risk analysis across 43 of the model parameters. For each of these parameters, the user can assign the parameter to a normal, uniform, or triangular distribution. CURRENT also has an experimental feature to assign parameters to a lognormal distribution, but this feature does not work in all cases. The research team recommends against using the lognormal distribution without careful consideration. Argo allows the CURRENT user to select how many simulations to include in the Monte Carlo simulation. Using more simulations produces higher fidelity for the final distribution at the expense of computation time. CURRENT is set to run 1,000 simulations by default.

For the 43 parameters that are a part of the risk assessment, the user can specify an expected lower value and upper value for the parameter. These bounds determine the shape of the uniform distribution and, along with the parameter's base value, the shape of the triangular distribution. For parameters assigned to a normal distribution, which is the default for most parameters in the risk analysis, the upper and lower bounds are used as part of a confidence interval, which is set to 95 percent by default. For example, if the user believes their project will have a catenary cost of

\$500,000/km (\$800,000/mile), but believes there is a 95 percent chance that the final catenary cost will fall between \$400,000/km and \$600,000/km, they will set the base catenary cost to \$500,000/km, the low value to \$400,000/km, the high value to \$600,000/km, and the confidence level to 95 percent. If the user were only 80 percent certain that the final catenary cost would fall within those values, they could change the confidence level to 80 percent or find the high and low values for which they feel the 95 percent confidence level would be appropriate.

Because the distributions are set by the low value and high value of each parameter, the average result of the risk analysis framework will be different from the result reported by the economic simulation if the base value used for the economic simulation is different from the mean of the distributions used in the risk analysis (i.e., if the base value is not exactly halfway between the high value and the low value).

Argo allows the user to examine the final distribution’s probability density function (pdf) or cumulative distribution function (cdf), which allows the user to answer questions such as, “What is the probability that the final rate of return for the railroad will be at least 18 percent?” Figure 55 and Figure 56 show, respectively, the pdf and cdf for a sample output from the private perspective with 5,000 simulations.

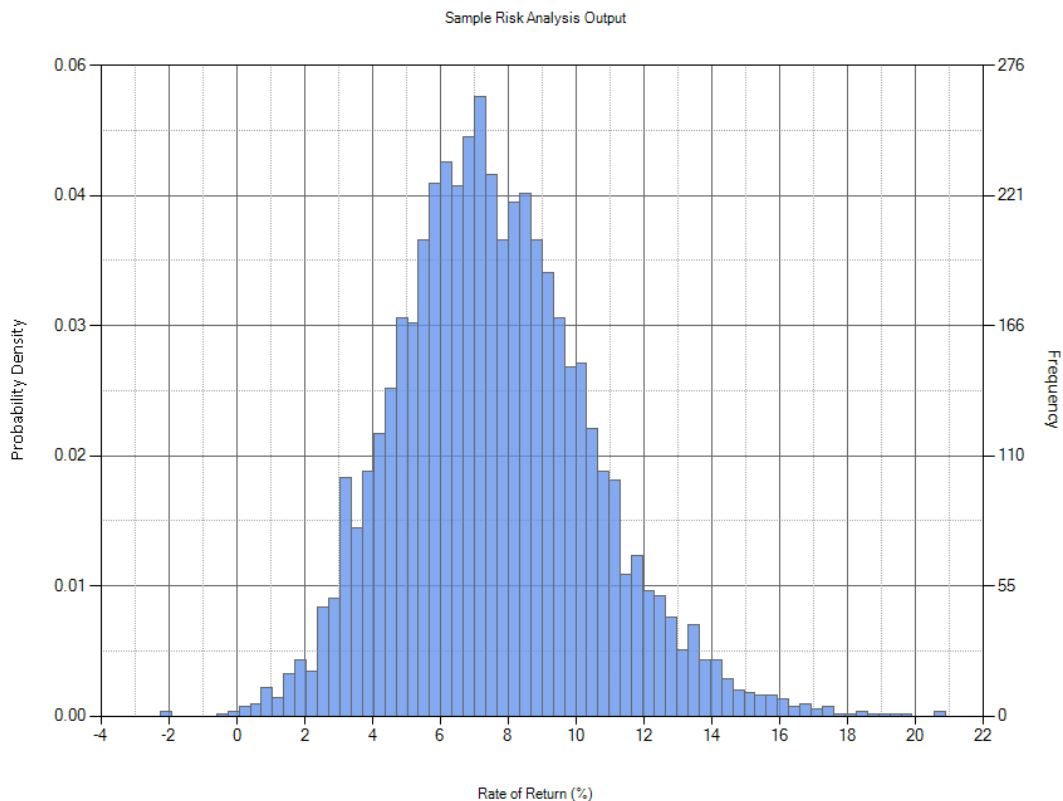

Figure 55. Sample pdf for 5,000 Simulations of CURRENT

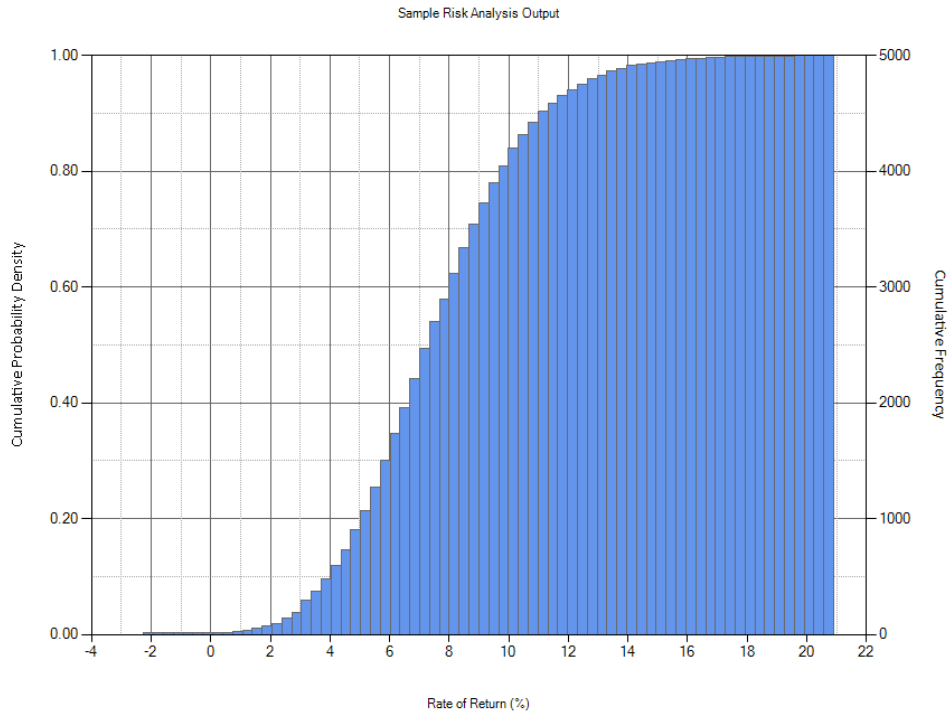

Figure 56. Sample cdf for 5,000 Simulations of CURRENT

11.3.1 Assumption of Independent Parameters

In its current form, CURRENT assumes that the parameters in the Monte Carlo simulation are independently distributed. Some parameters are likely correlated to some degree. For example, most of the construction cost parameters depend on the future cost of labor and the future cost of materials, and there is likely a correlation between the future cost of electricity and the future cost of diesel, if most diesel and some electricity are derived from fossil fuels. Because CURRENT does not account for these types of correlations, the final distributions predicted by CURRENT might tend to have higher variance than the actual distribution of the project’s economic results. CURRENT should still provide a reasonable examination of the roll uncertainty could play.

11.3.2 Risk Assessment Outputs

CURRENT is set up to perform a quick risk analysis of 16 simulation outputs – the internal rate of return and the 3 cost-benefit ratios for all 4 perspectives. If the distribution of possible results for a specific variable is of interest to the user, it would be possible to set that variable as an Argo result. For example, if the user were interested in how much a particular project might require the railroad to increase the annual budget of its maintenance department, it would be possible to examine row 1202 of CURRENT’s ‘MonteCarloCalcs’ worksheet and set a year after construction is complete to be an Argo result before re-running the Argo simulation. This type of analysis can become very nuanced, but greatly expands the number of questions for which CURRENT can provide estimates.

Additionally, the Argo interface allows users to perform sensitivity analysis for any of the 43 parameters included within CURRENT’s risk analysis framework. [Figure 57](#) shows an example

of the sensitivity analysis CURRENT can provide for three of the model's parameters. The example shows how the final rate of return from the private perspectives can change based on variables like the future cost of diesel, the cost of manufacturing electric locomotives, and the cost of building catenary along double track. Note that the numbers in Figure 57 are based on a test scenario.

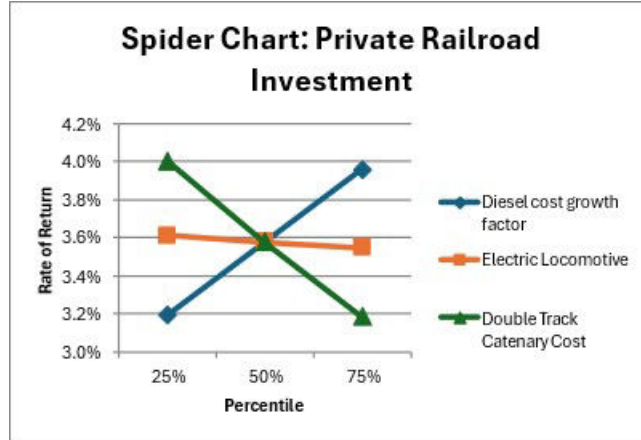

Figure 57. Example Sensitivity Analysis from CURRENT – By Utilizing the Argo Plugin, CURRENT Can Provide a Spider Chart for Specific Parameters of Interest

12. Case Study 1: Mine-to-Port Railway

The research team performed two case studies applying the CURRENT train performance model and economic toolkit to examine theoretical electrification projects of existing freight rail corridors. This section describes the first such case study, which examined a 169 km (108 mile) route between the Great Lakes port of Superior, WI, and the taconite iron ore mines near Hibbing, MN. [Section 13](#) discusses the other case study.

This route takes taconite iron ore roughly 260 m (850 ft) downhill, corresponding to an average grade of -0.24 percent for loaded trains heading to the port and 0.24 percent for returning unloaded trains. [Figure 58](#) shows the elevation profile of this route. All but roughly 400 meters (0.25 miles) of the corridor has a speed limit of 40 mph (64 kph or 18 m/s) for freight trains.

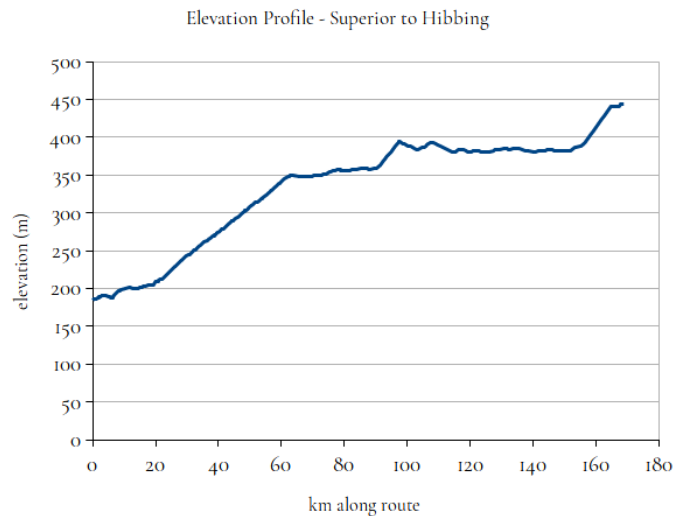

Figure 58. Elevation Profile of the Taconite Loop from Superior, WI, (km 0) to Hibbing, MN (km 169)

Because this route carries tonnage downhill, it might offer favorable economics for electrification. Conventional electrification via OCS performs better when there is more traffic to utilize the OCS. The relatively low traffic density along this corridor allows this case study to examine alternative options for electrification. This section offers examinations of four electrification scenarios for this corridor:

- Conventional electrification as a means of comparison
- Fully battery-powered electrification, in which significant battery charging infrastructure is built at the port and at the mine
- Intermittent electrification primarily via batteries with short segments of OCS to partially recharge the batteries en route and smaller recharging facilities at the route end points
- Intermittent electrification primarily via OCS with a small onboard battery capacity to provide power through gaps where the OCS infrastructure would be most expensive to construct

None of these scenarios examine the use of DMLs or other strategies to bring benefits forward because this corridor is short enough that OCS could be constructed along its entire length in less than one year. The second case study, described in [Section 13](#), explores some of those options.

These scenarios collectively provide a wide range of options for electrifying this corridor. All four scenarios use the following assumptions:

- Traffic along the corridor is assumed to be five trains per day in both directions
- Each train is assumed to have 180 iron ore hoppers of the following type:
 - 8.5 m (28 ft) length
 - 20 tonne (22 ton) tare weight
 - 68 tonne (75 ton) cargo capacity
- Trains traverse the corridor with a desired speed of 17.9 m/s (40 mph)
- Each train has three locomotives with a total power of 6.6 MW (9000 hp)

12.1 Scenario 1: Conventional Electrification with OCS

Scenario 1 examined conventional electrification of a 169 km (108 mile) route between the Great Lakes port of Superior, WI, and the taconite iron ore mines near Hibbing, MN. This scenario analyzes installation of OCS across the corridor’s entire length.

12.1.1 Description and Assumptions

This scenario consists of 169 route-km (105 route-miles) and 203 track-km (126 track-miles) of new OCS construction. The analysis assumes that five total substations will be required, for an average spacing of 34 km (21 miles). Additionally, the analysis assumes that the substations will each require 20 km (12 miles) of transmission lines on average to connect them to the grid.

The route has 11 bridges passing over the tracks, with 1244 m (4081 ft) of bridge spans. While OCS construction along a bridge is more expensive than OCS construction along flat ground, none of the bridges along the route’s length are of a type that might require reconstruction to accommodate OCS clearance. The research team did not have access to data about the heights of the 11 bridges passing over the tracks, and made the conservative assumption that all of them pose clearance restrictions. To allow for clearance, the analysis assumes that five of the bridges will require the track to be lowered while the other six will require the bridge to be raised.

CURRENT predicts that the OCS for this corridor would cost a total of \$300 million, which is equivalent to \$1.77 million per km (\$2.86 million per mile). [Table 31](#) shows the subtotals for this cost. By far the largest component is the predicted cost of shielding the signaling and communication system. This scenario assumes that 15 electric locomotives will be necessary.

Table 31. Cost Breakdown for the OCS Along the Mine-to-port Corridor

OCS Subtotals (\$ millions):	
Catenary	80
Substations	35
Transmission	5
Public Works	20
Signaling & Communication	160

12.1.2 Results

CURRENT predicts that electrifying this corridor via OCS would not be a worthwhile investment for the private railroad acting alone. Even with a favorable ROW sharing agreement, using OCS along the entire corridor would produce a negative investment for the railroad. CURRENT predicts that some form of public support would be necessary to achieve a maximum return for the railroad of up to 6.3 percent. In this case, the large upfront cost of the OCS is not offset by the energy savings or lease payments the railroad would receive. Figure 59 shows the net cash flow by year from the private and public perspectives.

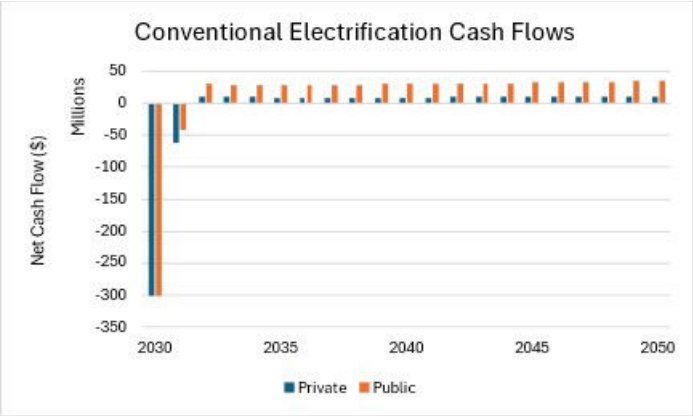

Figure 59. Private and Public Net Cash Flows for Conventional OCS on Taconite Loop

This scenario does show a positive return from the public perspective. This corridor lies entirely within the western part of the Midwest Reliability Organization (MROW) section of the grid, which is slightly dirtier on average than the US grid (428 g CO₂e/kWh versus 375 g CO₂e/kWh). Despite this, CURRENT predicts that this scenario would result in net savings of over 20,000 tonnes CO₂e per year, in addition to net reductions in NO_x, SO_x, and PM_{2.5}. CURRENT predicts an overall rate of return of 5.4 percent for the project from the public perspective. Table 32 summarizes the results of the economic analysis.

Table 32. Mine-to-Port Case Study – Conventional Electrification Results

Perspective	Net Present Value (\$ millions)			Internal Rate of Return	Cost-benefit Ratio		
	3%	7%	18%		3%	7%	18%
Purely Private RR Investment	-230	-268	-311	-5.7%	0.4	0.3	0.1
Private Investment with ROW Sharing	-143	-210	-287	-1.6%	0.6	0.4	0.2
Private Investment with ROW Sharing and Public Support	124	-20.7	-191	6.3%	1.3	0.9	0.5
Public Perspective	87	-45	-200	5.4%	1.3	0.9	0.4

By adjusting the traffic input in CURRENT, it is possible to determine at what point the purely private investment becomes positive. The traffic for this corridor would have to rise to 13 trains per day (along with 13 return trips) for the railroad to break even with no assistance. While this is 180 percent more than the traffic level assumed for this case study, the railroad could explore the possibility of shifting parallel traffic onto this corridor.

12.1.3 Risk Analysis

The Monte Carlo risk analysis produced a wide distribution of results. Figure 60 shows the distributions of the private and public rate of returns. Nearly all the private return simulations were negative, while the opposite was true for the public returns. The public returns have a longer right tail, with several simulations reaching returns of more than 15 percent. The inclusion of emissions benefits is responsible for the large shift between the perspectives. Figure 59 above showed the significant relative difference in the project’s annual cash flows when emissions are considered.

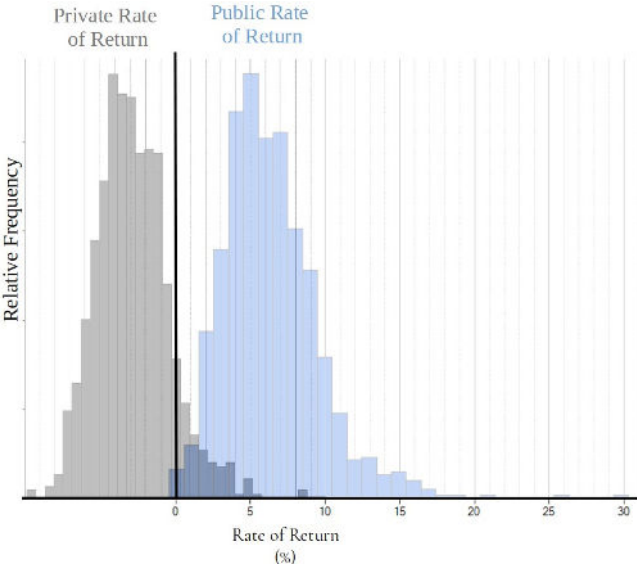

Figure 60. Risk Analysis Results of the Conventional Electrification Scenario from the Private Perspective and Public Perspective

12.2 Scenario 2: Intermittent Electrification with Short OCS Gaps

Scenario 2 examines electrification of the same corridor explored in Scenario 1 but focuses on intermittent electrification via OCS with short gaps covered by battery energy storage systems onboard the locomotives.

12.2.1 Description and Assumptions

The next scenario for electrifying this corridor still relies primarily on OCS for motive power, but includes a small battery capacity on the locomotives to allow for gaps in the OCS along and under bridges. For this scenario, the estimated cost of the electric locomotives was increased to account for the battery capacity, and the public works projects along the corridor were removed. The largest resulting gap would be roughly 600 m (2000 ft), which would require a total battery capacity of up to 215 kWh, or 72 kWh per locomotive. The locomotives would likely be designed with a significantly larger battery capacity, as this route does not produce enough locomotive demand to justify a custom design, and a battery capacity sufficient for larger distances offers operational flexibility. This scenario assumes that no dedicated charging facilities will be necessary, as the small batteries will be able to recharge directly from the OCS when they are not in use.

Compared to the conventional electrification scenario, this scenario removes OCS from 2.4 route-km (1.5 route-miles), or 2.8 track-km (1.8 track-miles), leaving 98.6 percent of the corridor under wires. Despite removing only 1.4 percent of the OCS, CURRENT calculates that this scenario would lower the corridor’s OCS cost from \$1.77 million/km to \$1.65 million/km (\$2.85 million/mile to \$2.66 million/mile), a 6.8 percent reduction.

There is broad uncertainty in the cost of electric locomotives for the North American heavy haul freight market, and even more uncertainty in the cost of BELs for the market. This scenario assumes that a locomotive with the small battery capacity required would cost \$250,000 more than an electric locomotive with no battery for propulsion.

12.2.2 Results

CURRENT projects that the savings in OCS for this scenario outweigh the extra cost of the locomotives. The overall value of the investment increases for all perspectives and all discount rates, with an increase in the net present value of roughly \$21 million. This increase in value does not change the overall conclusions from the conventional electrification scenario – utilizing small battery capacity to introduce gaps over the most expensive segments of OCS improves the investment, but public support would still be necessary to make the project feasible. [Table 33](#) summarizes the results. The next scenario examines what happens when the OCS is removed entirely.

Table 33. Mine-to-Port Case Study – Results of OCS with Short Gaps

Perspective	Net Present Value (\$ millions)			Internal Rate of Return	Cost-benefit Ratio		
	Discount Rate: 3%	7%	18%		3%	7%	18%
Purely Private RR Investment	-208	-247	-290	-5.2%	0.4	0.3	0.2
Private Investment with ROW Sharing	-122	-189	-265	-1.1%	0.7	0.5	0.2
Private Investment with ROW Sharing and Public Support	146	1	-169	7.0%	1.4	1.0	0.5
Public Perspective	108	-24	-179	6.1%	1.3	0.9	0.5

12.3 Scenario 3: Electrification via Batteries

This scenario examines electrifying the mine-to-port corridor entirely through batteries.

12.3.1 Description and Assumptions

This scenario involves no OCS construction, so this scenario has much lower capital construction costs. However, without any OCS, this configuration would require significant charging facilities to ensure locomotives do not have long downtimes while they are recharging. There is also uncertainty over the final battery capacity of BELs. This scenario assumes that each locomotive will have a charge capacity of 8 MWh. In addition to the 24 MWh of battery capacity across the three locomotives, this scenario assumes that each train will have four battery tenders capable of providing power to the locomotives’ DC link. Each battery tender in the simulation has a capacity of 9.65 MWh for a total battery capacity of 62.6 MWh along the consist.

The simulation assumes that each locomotive can interface with one fast charger and each battery tender can interface with two fast chargers, meaning a total of 11 fast chargers is necessary to achieve the maximum recharge rate of the consist. The simulation assumes that the corridor’s normal operations can be maintained without additional locomotives by installing a total of 33 1-MW chargers at the port and an additional eleven 1-MW chargers at the mine. At a cost of \$1 million for the installation of each fast charger, this amounts to a \$44 million facilities capital expense for the scenario.

12.3.2 Battery Train Simulations

Additional analysis would be necessary to determine the optimal train battery capacity and number of chargers, but these assumptions should provide a good baseline for how the battery electrification performs. With the scenario’s configuration, CURRENT’s train performance function predicts that the train will consume roughly half of its charge going uphill unloaded from the port to the mine. Once loaded at the mine, the topography of the route means CURRENT predicts only a quarter of its charge would be used on the return trip with several segments where the net charge is increased through regenerative braking. Figure 61 shows the train’s state of charge (SOC) for the unladen port-to-mine run, and Figure 62 shows the SOC for the laden return.

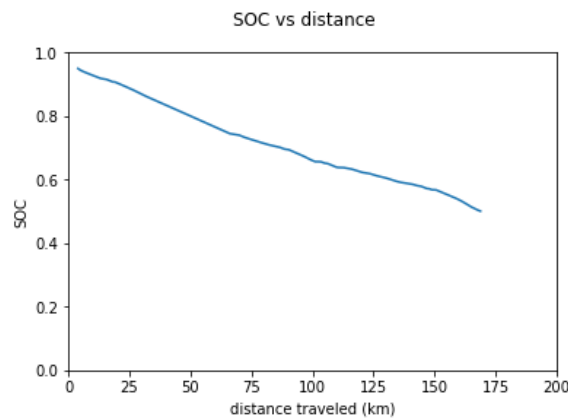

Figure 61. Battery State of Charge Versus Distance for a Fully Battery-powered Journey Unladen from the Port to the Mine

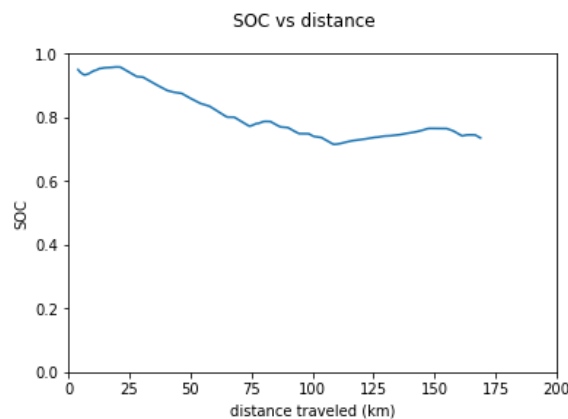

Figure 62. Battery State of charge Versus Distance for a Fully Battery-powered Journey Laden from the Mine to the Port

As shown in Figure 63, which overlays the two legs of the journey, the train can complete a full loop without receiving any charge at the mine. However, constructing a small recharging facility at the mine allows the train to take advantage of idling time and increases the margin for error. While Figure 63 indicates that the train would have roughly a quarter of its battery capacity remaining after completing the loop, this does not account for stoppages at sidings, unexpected delays, or gradual battery degradation over time. With a recharging facility at the mine, there is very little risk of the train running out of charge en route.

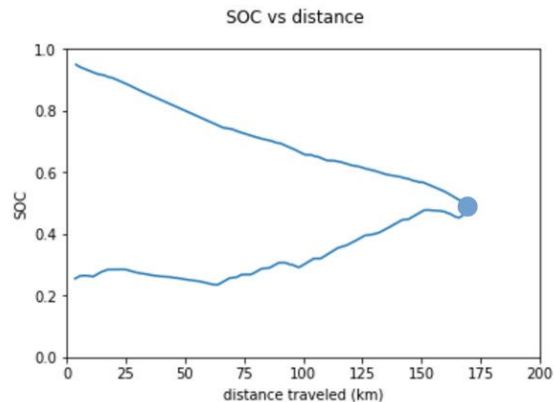

Figure 63. Overlay of the Train’s State of Charge Across a Full Loop Without Any Recharging Taking Place at the Mine

12.3.3 Results

Table 34 shows the economic results of the battery electrification scenario. As opposed to the previous two scenarios relying entirely or primarily on OCS, CURRENT predicts going to a fully battery solution generates a net positive investment for this corridor, albeit only barely, and falling short of even a 3 percent return. The results indicate that batteries would be a more suitable technology than OCS for this corridor, and that the railroad might be interested in electrifying this corridor with a significant level of public support. Additionally, as battery costs and the cost of fast charging facilities fall over time, corridors such as this will become more favorable investments.

Table 34. Mine-to-Port Case Study – Battery Electrification Results

Perspective	Net Present Value (\$ millions)			Internal Rate of Return	Cost-benefit Ratio		
	Discount Rate: 3%	7%	18%		3%	7%	18%
Purely Private RR Investment	-39	-74	-110	0.3%	0.8	0.5	0.3
Private Investment with ROW Sharing	45	-19	-88	5.6%	1.3	0.9	0.4
Private Investment with ROW Sharing and Public Support	305	166	6	18.8%	2.9	2.1	1.0
Public Perspective	261	138	-4	17.4%	2.7	1.9	1.0

12.4 Scenario 4: Intermittent Electrification via Batteries and Short OCS Recharging Segments

Scenario 4 for this corridor utilizes intermittent electrification similarly to Scenario 2, but relies primarily on batteries rather than OCS for the motive power.

12.4.1 Description and Assumptions

In this scenario, short sections of OCS along the corridor allow the train to partially recharge en route, reducing the amount of charging equipment required. CURRENT simulated the economics of electrifying several of the sidings along the corridor, amounting to 6 percent of the route’s length and 11 percent of the track length. This allows trains to lower their speeds while under wire if necessary to receive additional charge, without affecting the corridor’s overall throughput, and could possibly allow trains to recharge while waiting at sidings. The latter situation might require specialized pantographs and OCS, as a normal system can become damaged at the interface if it is transferring high power while the train remains stationary. The small amount of traffic along the corridor means that a normal substation would be capable of supplying power to recharge one of the trains.

This scenario assumes that, with the ability to partially recharge the trains en route, no additional charging facility will have to be built at the mine, and the charging facility at the port can be reduced from 33 fast chargers to only 11.

12.4.2 Results

CURRENT calculates that this scenario performs better than any of the others, with a 3.5 percent purely private rate of return and a public rate of return of 22.5 percent. Table 35 shows the scenario’s full economic results. These results show the potential for intermittent electrification strategies. Further simulation might be able to find an optimal balance between port charging facilities and en route charging via OCS segments. Because CURRENT does not include meet-pass functionality, external modeling would be necessary to estimate each train’s SOC after completing a loop from the port to the mine and back.

Table 35. Mine-to-Port Case Study – Results of battery with short OCS segments

Perspective	Net Present Value (\$ millions)			Internal Rate of Return	Cost-benefit Ratio		
	Discount Rate: 3%	7%	18%		3%	7%	18%
Purely Private RR Investment	6	-35	-81	3.5%	1.1	0.7	0.4
Private Investment with ROW Sharing	93	23	-56	9.0%	1.8	1.2	0.6
Private Investment with ROW Sharing and Public Support	356	210	39	24.3%	4.2	2.8	1.3
Public Perspective	314	182	27	22.5%	3.8	2.5	1.2

12.4.3 Risk Analysis

In CURRENT’s risk analysis, 1 out of 1,000 simulations generated a net loss from the private perspective, but 95 percent of simulations generated a rate of return between 1.6 percent and 11.4 percent. The simulations have a mean return of 6.4 percent and a standard deviation of 2.4

percent. Figure 64 shows the distribution of private rates of return across the risk analysis. Figure 65 shows the distribution of public rates of return, which have a wider distribution with a longer right tail – the public return has a mean of 23.5 percent and a standard deviation of 3.7 percent.

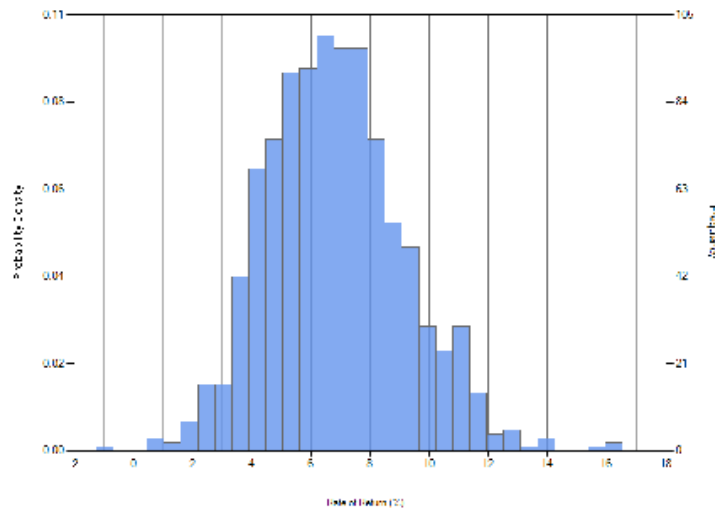

Figure 64. Distribution of the Private Rate of Return for Scenario 4 of the Mine-to-port Study, Analyzing Short Recharging Segments Along the Corridor

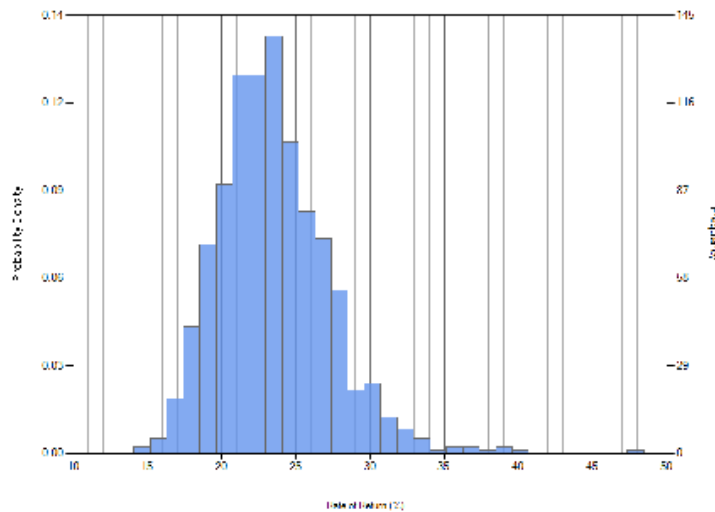

Figure 65. Distribution of the Public Rate of Return for Scenario 4 of the Mine-to-port Study, Analyzing Short Recharging Segments Along the Corridor

Based on the risk analysis, electrifying this corridor with battery trains and short OCS recharging segments along the sidings has a very high chance of being profitable for the railroad acting alone, and would probably be a worthwhile investment for some form of public-private partnership.

12.5 Case Study Conclusions

12.5.1 Comparison of Scenarios

Of the four scenarios considered, intermittent electrification relying primarily on batteries performed the best for this corridor. Figure 66 shows the public and private rates of return for each scenario. All the scenarios have a positive rate of return when public benefits are included, but the private returns ranged from a net loss in the scenarios relying primarily on OCS to a small profit for the last scenario.

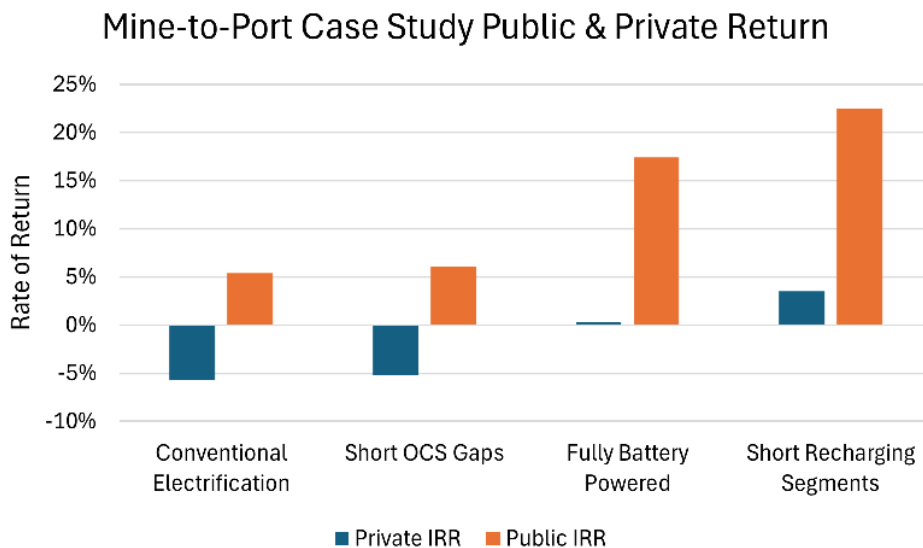

Figure 66. Summary of the Public and Private Rates of Return for the Four Scenarios in the Mine-to-port Case Study

These rates of return point to the importance of involving public policy to bring about emissions reductions along shorter rail corridors with relatively low traffic. CURRENT shows there is a net public benefit to electrifying such corridors, but there is no private incentive to make this investment without a public policy to internalize the negative externality created by the corridors' emissions.

12.5.2 Importance of Choosing an Appropriate Time Horizon for Analysis

The period of analysis has a significant impact on the overall feasibility of the project. Like many infrastructure projects, rail electrification involves large upfront expenses and benefits that accrue over time. Analysis of private investments tends to use a shorter time horizon than analysis of public investments, due to a desire for quick returns. Figure 60 shows how the analysis of conventional electrification, the scenario which performed worst in the economic analysis, varies within each perspective as the time horizon changes. As the time horizon increases, more project benefits are included and the overall rate of return increases asymptotically. The economic outcomes for these scenarios are all based on a 20-year time horizon, which is a middle ground between private investments and public investments. As shown in Figure 67, all perspectives for the conventional electrification scenario have a negative rate of return if only the first 10 years of the project are considered, while all perspectives have a

positive return in a 50 analysis. This demonstrates the importance of choosing a time horizon that makes sense for all the stakeholders involved in a project.

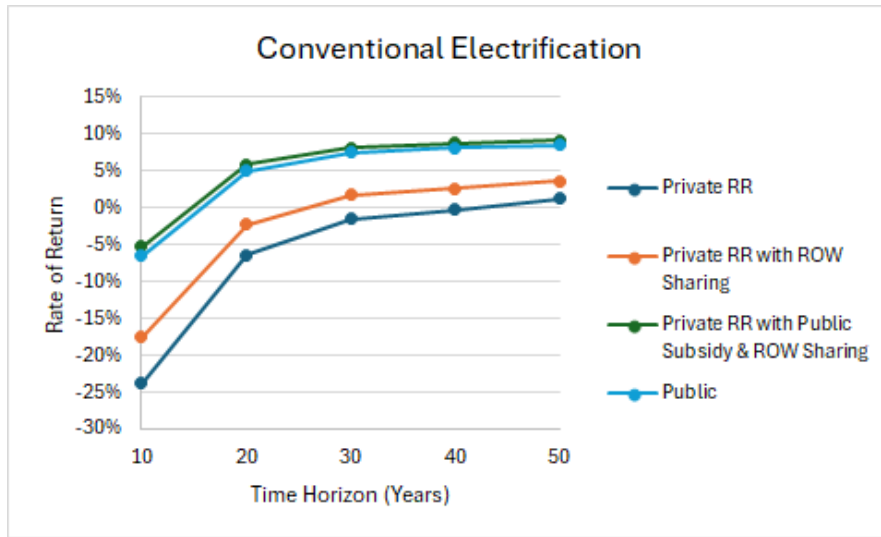

Figure 67. Because Project Costs are Upfront and Benefits Continue Into the Future, the Rate of Return Increases Asymptotically as the Time Horizon for the Analysis Increases Because Fewer Project Benefits Are Truncated

While the other scenarios do not show as stark a contrast (going from net loss to net gain in all perspectives), they all follow a similar trend in sensitivity to the period of the analysis.

13. Case Study 2: Double-Track Mainline Corridor

The second case study examines the electrification of a long segment of a double-tracked mainline corridor. This corridor extends 1023 km (636 miles) from Kansas City, KS, to Clovis, NM. Those endpoints have extensive rail yards in which trains stop for inspections, refueling, and sorting railcars, which makes this corridor a natural subdivision in which to consider electrification. The primary traffic along this corridor is intermodal trains en route from Los Angeles to Chicago, constituting roughly 60 percent of the corridor’s traffic. Other traffic includes manifest trains and a small portion of westbound bulk trains. The quantity and heterogeneity, in addition to the length of this corridor, put it in stark contrast to the port-to-mine route analyzed in the first case study. [Table 36](#) lists the trains modeled for this case study, which amounts to 60 trains per day and 224 locomotives operating along the corridor.

Table 36. Trains Modeled Along the Mainline Rail Corridor

Train Type	Direction	Trains Per Day	Locomotives	Railcars
Intermodal	Eastbound	18	4	150 double-stack intermodal cars (300 total containers)
Empty Intermodal	Westbound	18	4	150 empty intermodal cars
Manifest	Eastbound	8	3	77 loaded box cars (143 gross tons each) 38 empty box cars (33 gross tons each)
Manifest	Westbound	8	3	
Bulk	Westbound	4	4	125 loaded hopper cars (143 gross tons each)
Empty Bulk	Eastbound	4	4	125 unloaded hopper cars (33 gross tons each)

From Kansas City, KS, to Clovis, NM, the corridor rises just over one km (1063 m, or 3788 ft) for an average grade of 0.1 percent. The ruling grade is 2.07 percent in the westbound direction, and 1.0 percent in the eastbound direction. [Figure 68](#) shows the corridor’s elevation profile in the westbound direction, which is the direction of ascending mileposts. Because most of the tonnage along the corridor is eastbound, there is good potential along this corridor for electric trains to utilize regenerative braking for increased efficiency.

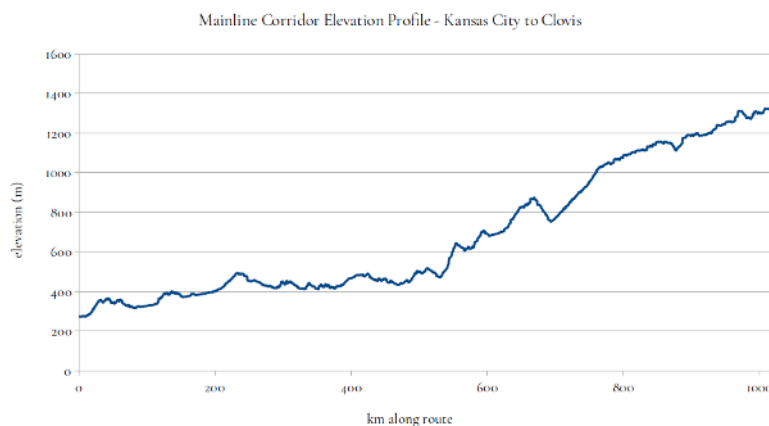

Figure 68. Elevation Profile of the Mainline Corridor Analyzed in Case Study 2 – The Route Rises Just Over One Kilometer from Kansas City, KS, to Clovis, NM

The corridor is almost entirely double tracked today. This case study uses 2030 to 2050 as the period of analysis, and assumes that the entire corridor is double-tracked by 2030, meaning that all OCS must be constructed for double-tracked segments.

There are 324 railway bridges along the corridor totaling 13.1 route-km (8.1 route-miles). Researchers identified six of those bridges as potentially posing clearance issues to OCS, totaling 380 m (1250 ft). In addition, there are 60 roadway bridges passing above the corridor, which could also pose clearance issues to OCS. As in the previous case study, researchers do not have data about the height of these bridges, and have assumed that all potential clearance issues will increase the overall OCS cost. The case study assumes that half of the bridge overpasses will require raising the roadway bridge, while the other half can achieve adequate clearance by lowering the tracks.

13.1 Scenario 1: Conventional Electrification with OCS

The first scenario analyzed in this case study is that the entire corridor is electrified through the conventional approach with OCS across its entire length.

13.1.1 Description and Assumptions

CURRENT predicts that the OCS for this corridor will cost \$2.05 billion in total, for an average cost of \$2.0 million/km (\$3.2 million/mile), and that the construction will take slightly over four years. [Table 37](#) shows the subtotals for the OCS construction, and [Figure 69](#) shows the capital costs by year.

Table 37. Subtotals of the Conventional Electrification OCS Cost for the Mainline Corridor Case Study

OCS Subtotals (\$ millions):	
Catenary	754
Substations	149
Transmission	25
Public Works	149
Signaling & Communication	969

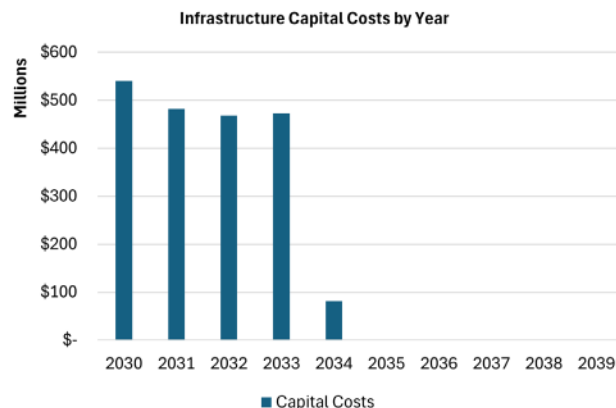

Figure 69. Capital Costs by Year for the Conventional Electrification of the Mainline Corridor – CURRENT Predicts That Construction of the OCS Will Take Slightly Over Four Years

In this scenario, 224 electrical locomotives are acquired once the OCS is complete, replacing all 224 diesel-electric locomotives at once. Figure 70 shows the overall project cash flows by year. Note that while the case study considers a project time horizon of 2030 to 2050, CURRENT calculates the cash flow for years beyond the time horizon, and then uses the years that are part of the analysis for the economic calculations. The cash flows show the negative position created by the capital expenditures for the OCS in the initial years of the project followed by a large expenditure on equipment acquisition once operations are ready to begin and benefits can begin to accrue. Cash flows from that time onward include positive cash flows from the project benefits and negative cash flows from the project’s cost of operations (primarily the cost of electricity and maintenance). One category of note is health emissions. Within Figure 70, the health benefits cash flow is positive once operations begin, but diminish each year. This is because the base case for this study assumes that older diesel-electric locomotives will be replaced by Tier 4 diesel-electric locomotives over time, and Tier 4 diesel-electric locomotives are cleaner (outside of carbon emissions, which fall within the climate emissions category) than the electricity grids along this corridor. CURRENT does not change the emissions factors for the electricity grid over time, so while it is likely that the electricity grid will become cleaner, CURRENT does not factor this in. In effect, CURRENT makes a conservative estimate of the overall health benefits.

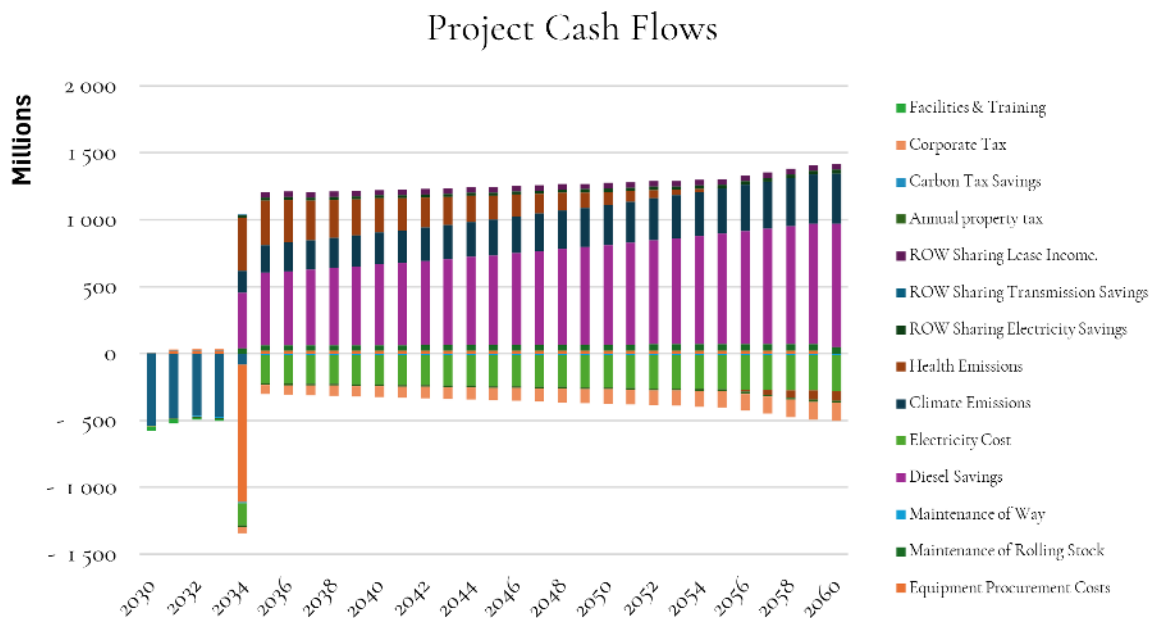

Figure 70. Project Cash Flows for Conventional Electrification of the Mainline Corridor

13.1.2 Results

CURRENT estimates that conventional electrification would bring about a positive return for this corridor. Table 38 presents the estimated economic returns. This corridor moves across a region with plentiful solar and wind potential, which could increase the potential for a ROW sharing agreement.

Table 38. Mainline Case Study – Conventional Electrification Results

Perspective	Net Present Value (\$ millions)			Internal Rate of Return	Cost-benefit Ratio		
	Discount Rate:	3%	7%		18%	3%	7%
Purely Private RR Investment	1320	48	-1170	7.2%	1.4	1.0	0.5
Private Investment with ROW Sharing	2060	538	-975	9.3%	1.7	1.2	0.6
Private Investment with ROW Sharing and Public Support	7870	4440	643	22.9%	3.7	2.7	1.3
Public Perspective	8280	4700	728	23.5%	4.0	2.8	1.3

While the private returns are positive, they might not be high enough to incentivize the railroad to electrify this corridor on its own. The corridor’s potential for emissions reductions brings about very high returns from the public perspective.

13.1.3 Risk Analysis

For most of the economic simulations run, the private rate of return varies between 6 percent and 16 percent with a long right tail. Figure 71 shows the distribution of the rate of return for CURRENT’s risk analysis simulation.

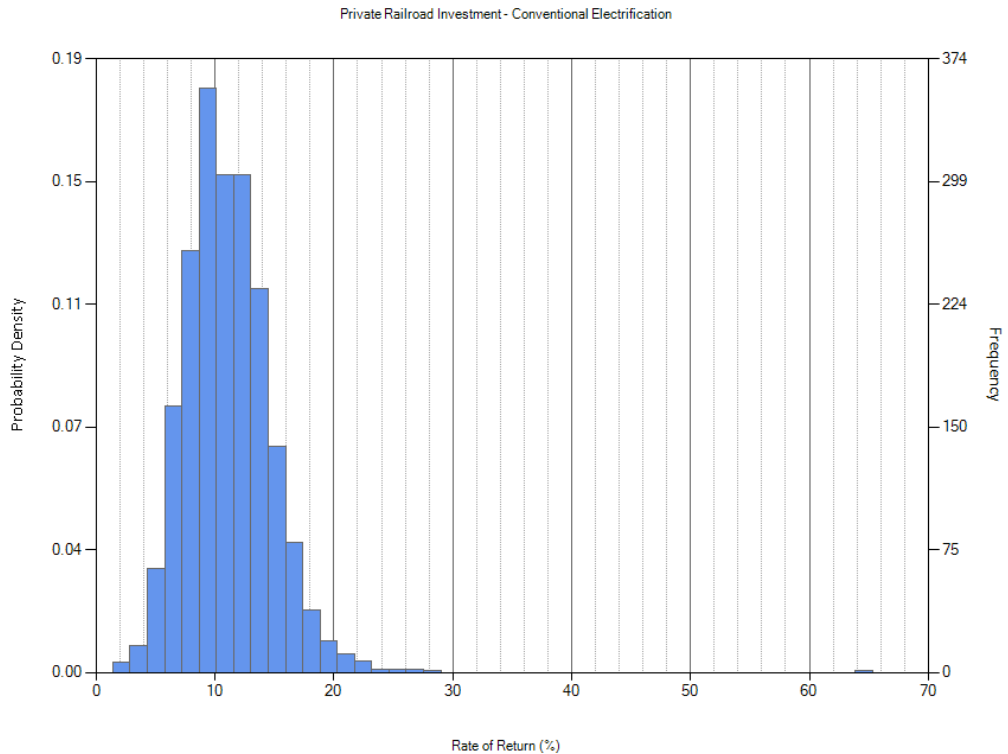

Figure 71. Distribution of the Private Rate of Return for Conventional Electrification of the Mainline Corridor

13.2 Scenario 2: Intermittent Electrification with Short OCS Gaps

This scenario examines how the OCS cost can be reduced by using electric locomotives with a relatively small ‘last mile’ battery capacity that allows them to cross gaps in the OCS where there would be clearance obstructions.

13.2.1 Description and Assumptions

Within the conventional electrification scenario, those clearance obstructions require expensive public works for the OCS construction. By using batteries to avoid constructing OCS along those segments, the overall OCS construction cost can be reduced with the tradeoff of a slightly more expensive electric locomotive. Analysis of the corridor reveals that it should be possible to avoid all possible OCS clearance obstructions by reducing the overall OCS length from 1023 route-km (636 route-miles) to 1007 route-km (626 route-miles), a 1.6 percent reduction in the overall OCS length. This reduces the OCS cost by 7.8 percent, from \$2.0 million/km (\$3.2 million/mile) to \$1.84 million/km (\$2.96 million/mile).

This scenario assumes that an electric locomotive with a last-mile battery will cost 10 percent more than a conventional electric locomotive (\$470,000). This is more than the electric locomotive cost used in a similar scenario in the previous case study because this corridor has longer gaps, and the railroad would have use for electric locomotives capable of traveling autonomously along short spurs along this corridor. The previous case study examined a much more self-contained corridor, which can allow the locomotives to follow the same path in regular operations.

13.2.2 Results

CURRENT shows a modest increase in returns from the project by using batteries to bridge short OCS gaps. For the assumed values, the savings on public works outweigh the cost of the more expensive locomotives. [Table 39](#) shows the results.

Table 39. Mainline Case Study – Results of Intermittent Electrification with Short OCS Gaps

Perspective	Net Present Value (\$ millions)			Internal Rate of Return	Cost-benefit Ratio		
	Discount Rate: 3%	7%	18%		3%	7%	18%
Purely Private RR Investment	1410	147	-1070	7.7%	1.5	1.1	0.5
Private Investment with ROW Sharing	2160	637	-871	9.8%	1.8	1.2	0.6
Private Investment with ROW Sharing and Public Support	7960	4540	747	24.1%	3.8	2.8	1.4
Public Perspective	8370	4800	830	24.6%	4.1	2.9	1.4

13.3 Scenario 3: Intermittent Electrification with Batteries and Short OCS Recharging Sections

This scenario investigates intermittent electrification with batteries being used over short OCS gaps. Because this is a much longer corridor than the mine-to-port loop considered in the first case study, the intermittent electrification analysis considered much higher OCS coverage.

13.3.1 Description and Assumptions

Intermittent electrification has a myriad of design variables that can be optimized, such as the number of OCS segments, the length of each segment, where each segment should begin, and the maximum battery charge rate under OCS. This case study considers only the overall OCS coverage percentage and the charge rate. Once an alternative is chosen for the corridor, careful engineering design work would need to go into the specific siting of OCS segments along the corridor, but this type of analysis is helpful to determine the overall OCS coverage and battery capacity necessary. To reduce computation time, only one electric train of each train type in each direction was simulated, and the battery state-of-charge was approximated based on the electric train’s power draw and regenerative braking at each timestep. This means that the trains simulated in the train performance function scenario are 1 to 5 percent lighter than the battery-electric trains included in the economic simulation because the battery sizing was calculated based on the train performance function results.

Figure 72 shows the estimated SOC for an eastbound intermodal train – the primary revenue generator for the corridor’s traffic – with four 8 MWh BELs and four 9.65 MWh battery tenders, and a 30 km (19 miles) OCS segment every 100 km (62 miles) along the corridor. The light orange rectangles in Figure 72 show where OCS is present, and the SOC increases within those segments. The battery simulation in Figure 72 assumes that the OCS can charge the train’s batteries with a total of 24 MW in addition to providing up to 12.6 MW to the train’s traction motors (four 4300 hp locomotives). In effect, this means the OCS would be supplying up to three trains worth of power for each train along the corridor. The amount of power involved might require specialized pantographs and more expensive catenary and substations for the shorter OCS segments in this scenario. For the CURRENT economic simulation, the catenary cost was increased by a factor of 25 percent and the substation cost was doubled. These types of estimates can become more refined as freight intermittent electrification projects receive more testing in the field.

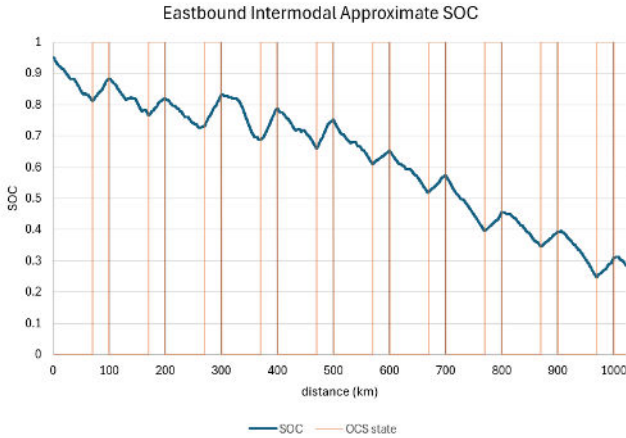

Figure 72. Approximate SOC for an Eastbound Intermodal Train Along the Corridor with 30 Percent OCS Coverage and 24 MW Battery Charging Capacity

As indicated in Figure 72 above, the SOC for the eastbound intermodal trains under this OCS configuration would fall to under 30 percent by the end of the corridor. Figure 73 shows how the battery SOC would vary along the corridor under different OCS configurations. In this SOC analysis, each type of OCS coverage has the same number of OCS segments with higher

coverage corresponding to longer segments. Like in Figure 72, the center-points for each OCS segment are spaced every 100 km. Figure 73 shows that, at 20 percent coverage, roughly 30 MW of charging capacity would be required (the dotted green line, which just completes the route). At 24 MW of charging capacity, 20 percent OCS coverage would be insufficient (the dotted orange line), but 40 percent coverage would result in a final SOC for this train of roughly 72 percent (the bold orange line). One way the information in this plot can be used is to avoid building too much OCS. For example, at 30 MW charging capacity and 40 percent coverage (the bold green line), there are several sections where the battery reaches maximum charge under the OCS, leaving no room for regenerative braking after the OCS section (until sufficient charge is expended) and meaning that the project has over budgeted for some combination of OCS, charging capacity, or battery capacity. This situation might be desirable if the railroad plans to build no charging facilities at the corridor end points.

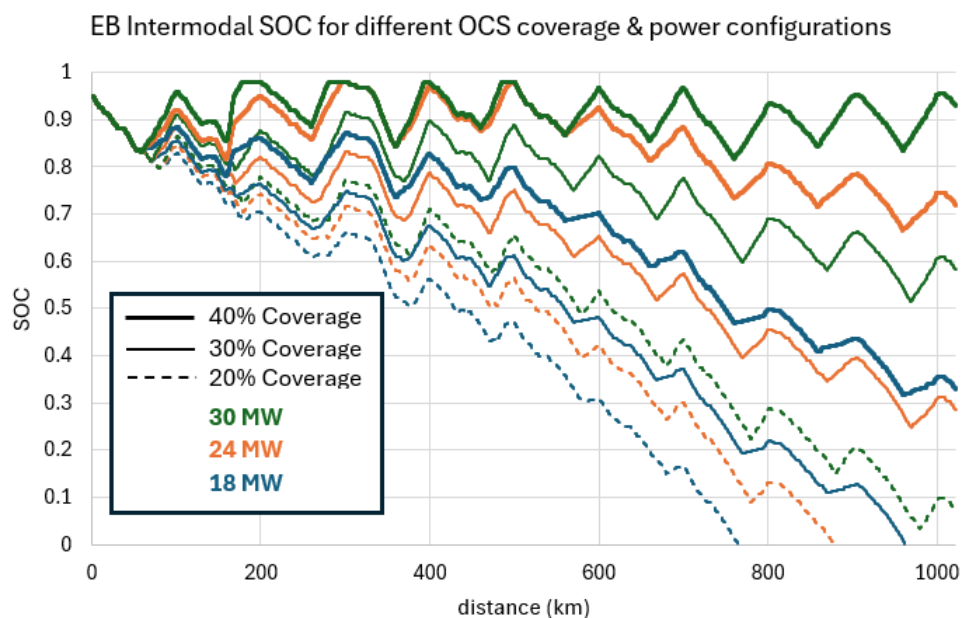

Figure 73. SOC for Eastbound Intermodal Trains Assuming Different Levels of OCS Coverage and Different Levels of Maximum Power in the OCS

Selecting OCS coverage and power becomes more complicated once all train types in both directions are considered. For this scenario, 30 percent coverage with 24 MW charging capacity is assumed, amounting to 307 route-km (191 route-miles) or 614 track-km (382 track-miles) of OCS construction. The scenario additionally assumes that OCS segments will be located to avoid all significant public works costs. To ensure adequate battery charge for all trains, this scenario will assume that all 224 of the corridor’s diesel-electric locomotives will be replaced with BELs with 8 MWh battery capacity and that a total of 336 battery tenders will be acquired (1.5 battery tenders per BEL). Most trains will use one battery tender per BEL, while bulk trains will use more BELs to ensure they can traverse the corridor as they travel loaded uphill. This number of tenders should allow for a small number of spare tenders to be kept at the corridor endpoint yards to ensure pre-charged tenders can be connected to consists as operations require. The scenario additionally assumes that the project will require \$260 million of charging and maintenance

facilities between the two corridor endpoints. This should allow for up to 10 trains to be recharging simultaneously at either yard.

CURRENT calculates that 75 percent of the corridor’s OCS segments can be constructed in the first year of the project, while the remaining segments would be constructed in the second year. Rather than waiting until all segments are constructed, it should be possible to have a transition period in which trains operate with a mixture of the existing diesel-electric locomotives and the new BELs and battery tenders to begin partial electric operations sooner (this will require careful phasing of which OCS segments to construct first).

With the increased catenary cost and substation cost, but reduced number of substations and public works costs, CURRENT predicts that the OCS will cost \$1.73 million per route-km (\$2.78 million per route-mile). Table 40 shows the subtotals for the OCS.

Table 40. OCS Subtotals for Intermittent Electrification with Short Recharging Segments

All values in \$ millions:	
Catenary	85
Substations	142
Transmission	12
Public Works	0
Signaling & Communication	291

13.3.2 Results

CURRENT predicts that this type of intermittent electrification brings about a large positive ROI. The corridor would bring about an 8.3 percent return for the railroad with a purely private investment. This is likely high enough to justify the investment, but probably not as large as some competing investments the railroad could make. A ROW sharing agreement might increase this return to 10.6 percent, which begins to look more attractive for the railroad. From the public perspective, electrifying the corridor in this manner brings about a 36.9 percent return, which is very high for a public investment. At a 7 percent discount rate, the project has a net present value of over \$6.2 billion. Table 41 summarizes how this scenario performs.

Table 41. Mainline Case Study – Results of Intermittent Electrification with Batteries and Short Recharging Sections

Perspective	Net Present Value (\$ millions)			Internal Rate of Return	Cost-benefit Ratio			
	Discount Rate:	3%	7%		18%	3%	7%	18%
Purely Private RR Investment		1530	279	-1060	8.3%	1.5	1.1	0.6
Private Investment with ROW Sharing		2310	806	-835	10.6%	1.8	1.3	0.7
Private Investment with ROW Sharing and Public Support		9530	6020	1850	35.7%	4.2	3.2	1.8
Public Perspective		9890	6270	1980	36.9%	4.4	3.3	1.8

13.3.3 Risk Analysis

CURRENT’s risk analysis showed a positive ROI for all simulations from all perspectives. Ninety-five percent of the simulations showed that the purely private investment would have a

rate of return between 5.7 and 18.6 percent. [Figure 74](#) shows the distribution of the private rate of return across 2,000 simulations. For the public perspective, 95 percent of simulations showed a rate of return between 29.2 percent and 48.2 percent. At a 7 percent discount rate, this corresponds to a project cost-benefit ratio between 2.4 and 4.2. [Figure 75](#) shows the distribution of the public rate of return.

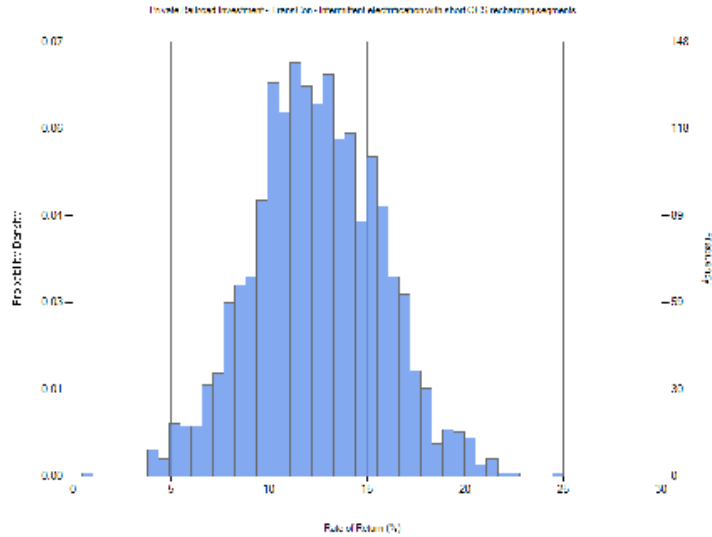

Figure 74. Distribution of the Private Benefits with En Route Recharging

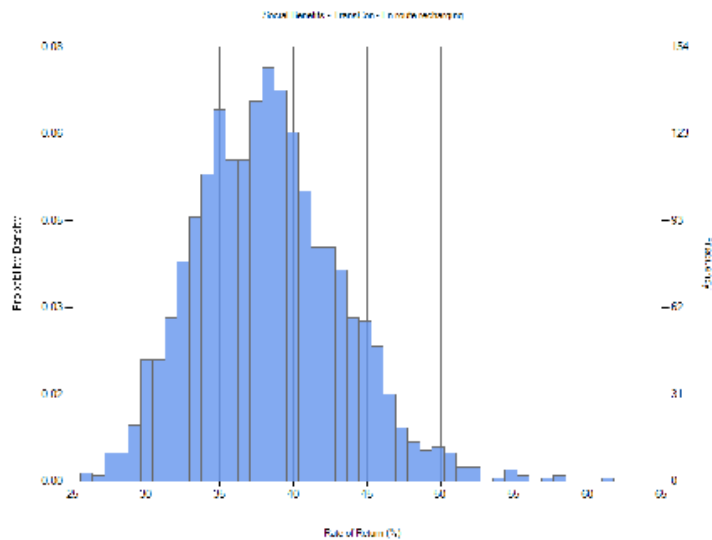

Figure 75. Distribution of the Public Rate of Return with En Route Recharging

Overall, this scenario points to a high likelihood of this project bringing about a favorable ROI.

13.4 Scenario 4: Progressive Electrification with Dual-mode Locomotives

In this scenario, both the conventional electrification and short OCS gap scenario were re-run using DMLs with EPTs.

13.4.1 Description and Assumptions

This corridor is long enough to test how DMLs might be used to begin providing electrification benefits before construction is complete. Because CURRENT predicts that the capital construction of the third scenario using short OCS recharging segments would take less than two years, that scenario was not re-analyzed with DMLs, as there would not be enough time for the DMLs to provide benefits before the project would come online.

13.4.2 Results

In both cases, using DMLs to implement progressive electrification improves the project’s economic performance. Table 42 and Table 43 summarize the results of the progressive electrification.

Table 42. Mainline Case Study – Results of Applying Progressive Electrification to the Conventional Electrification Scenario

Perspective	Net Present Value (\$ millions)			Internal Rate of Return	Cost-benefit Ratio			
	Discount Rate:	3%	7%		18%	3%	7%	18%
Purely Private RR Investment		1280	81	-1100	7.4%	1.4	1.0	0.5
Private Investment with ROW Sharing		2050	589	-888	9.7%	1.7	1.2	0.6
Private Investment with ROW Sharing and Public Support		8280	4890	1060	27.2%	3.8	2.8	1.5
Public Perspective		8690	5150	1150	27.9%	4.1	3.0	1.5

Progressive electrification does increase the rate of return from all perspectives, but it appears to increase benefits from the public perspective to a greater extent. The emissions benefits are large enough that allowing them to accrue in the initial years of the project provides higher marginal benefits in the public perspective than the private perspective.

Table 43. Mainline Case Study – Results of Applying Progressive Electrification to the Intermittent Electrification Scenario with Short OCS Gaps

Perspective	Net Present Value (\$ millions)			Internal Rate of Return	Cost-benefit Ratio			
	Discount Rate:	3%	7%		18%	3%	7%	18%
Purely Private RR Investment		1410	213	-962	8.1%	1.5	1.1	0.5
Private Investment with ROW Sharing		2180	720	-755	10.5%	1.8	1.3	0.6
Private Investment with ROW Sharing and Public Support		8410	5020	1190	29.1%	4.0	3.0	1.6
Public Perspective		8810	5280	1280	29.8%	4.3	3.2	1.6

For the two scenarios with extensive OCS construction – the conventional electrification with full OCS along the extent of the corridor, and the intermittent electrification with short OCS gaps – the CURRENT simulations were re-run with DMLs and EPTs (see Figure 76). Within the

simulation, after the infrastructure for the corridor is fully built out, the DMLs are slowly phased out over time for electric locomotives.

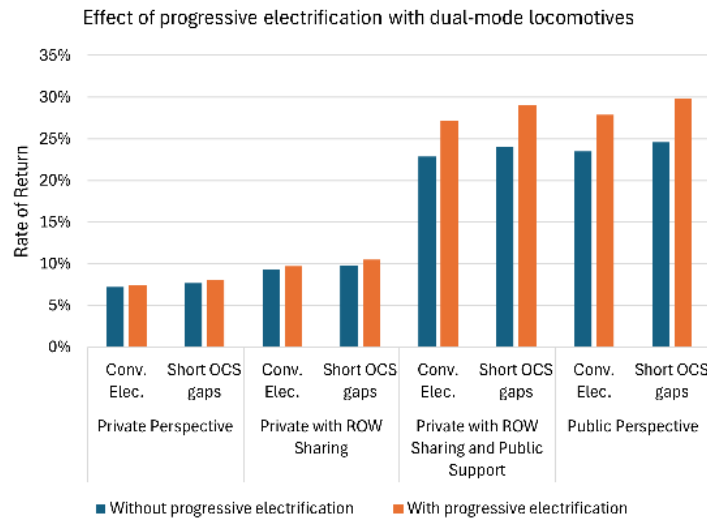

Figure 76. Comparison of the Rate of Return from Each Perspective With and Without Progressive Electrification

13.4.3 Risk Analysis

Figure 77 and Figure 78 show the distributions of the private and public rates of return, respectively. The overall shape of the distribution of the rates of return remains the same (including the long right tail), but the distributions are shifted to the right due to the overall better return offered with DMLs.

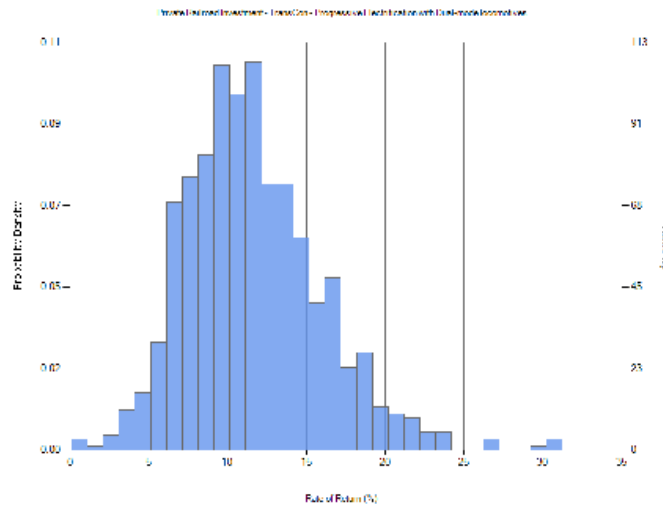

Figure 77. Distribution of Private Rate of Return for Progressive Electrification with Short OCS Gaps Using DMLs

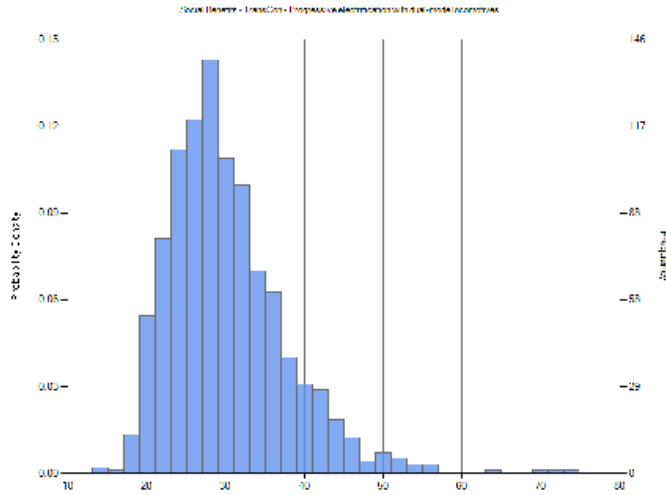

Figure 78. Distribution of Public Rate of Return for Progressive Electrification with Short OCS Gaps Using DMLs

13.5 Case Study Conclusions

For the four methods of electrification considered in this case study, intermittent electrification with short OCS recharging sections had the highest private and public rates of return (see [Table 44](#)). While the private rate of return was similar in all four scenarios, the public rate of return varied much more, rising from a low of 23.5 percent in the conventional electrification scenario to a high of 36.9 percent with intermittent electrification using short OCS recharging segments. The traffic density of the mainline corridor improves the economic efficiency of electrifying it, which suggests that a mainline corridor should be considered for electrification before shorter low-traffic corridors. When electrification is first pursued, there will be higher costs and greater uncertainty (costs will drop as experience increases and technologies mature). The better overall returns of a mainline corridor improve the chance that the initial investment will be profitable.

Table 44. Summary of the Public and Private Rates of Return for the Four Scenarios Analyzed Within the Mainline Corridor Case Study

Scenario	Private Internal Rate of Return	Public Internal Rate of Return
Conventional Electrification	7.2%	23.5%
OCS with Short Gaps	7.7%	24.6%
Intermittent Electrification with OCS Recharging Sections	8.3%	36.9%
Progressive Electrification with Dual-Mode Locomotives	8.1%	29.8%

In both case studies, conventional electrification had the lowest ROI of the scenarios considered (see [Figure 79](#)). This points to the ability of newer technologies to improve the feasibility of rail electrification. The best performing scenario in both case studies was a form of intermittent electrification, but the implementation of intermittent electrification was very different for the

two corridors considered. The port-to-mine implementation involved electrifying only 6 percent of the route’s length, while the mainline implementation involved electrifying 30 percent of the route’s length. Different corridors will require different solutions for decarbonization.

For both case studies, partnership agreements with utility companies improve the investment. The case studies show that there is a need for an understanding between railroads and electric utility companies that can facilitate discussions of ROW sharing agreements.

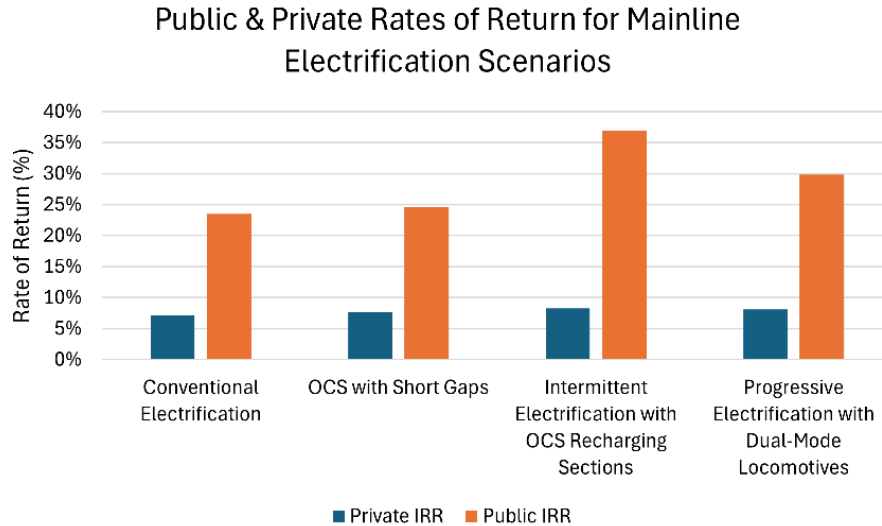

Figure 79. Summary of the Public and Private Rates of Return for the Four Scenarios Analyzed Within the Mainline Corridor Case Study

The final takeaway from both case studies is that a public policy to internalize emissions externalities would turn rail electrification from a potentially good investment to a very favorable investment. There is large room for public grants, publicly backed loans, or tax policy that will incentivize rail electrification directly or indirectly.

14. Conclusion

Reviewing previous freight rail electrification studies indicates that freight rail electrification has not been implemented by US Class 1 railroads because of various economic, technical, and institutional barriers. The primary barriers to freight rail electrification were found to be its high up-front capital costs, high risks due to the uncertainty of electrification in the North American context, and the presence of alternative investments that carried less risk. Over time, changing technology and a shift from electrification for reduced energy costs to electrification that benefits the environment and public through reduced emissions have potentially altered the impact and relevancy of some of these barriers, and created pathways to overcome them.

Overall, there are multiple modern technologies and implementation strategies with the potential to address economic, technical, and institutional barriers while improving the costs or benefits of freight rail electrification. Many modern advances in freight rail electrification technology and strategy address multiple economic barriers on multiple fronts, including mapping methods to streamline catenary construction, locomotive technologies, intermittent electrification, and implementation strategies to the primary economic barriers. Although individual design improvements may decrease costs, more systemic changes such as adopting alternative project delivery methods can directly address costs, benefits, and risk. More frequent freight rail electrification projects will allow for the maturity of a dedicated design, supply, and construction industry that can develop standards, guidelines, and best practices that will greatly decrease costs compared to the current situation of custom “one off” approaches for infrequent projects. DMLs for freight service and intermittent electrification are important approaches to improve project economics by moving benefits forward, but both require further research to prove their technical feasibility and determine more specific costs. Implementation strategies offer the most promising pathways for improving freight rail electrification economics through utility lease agreements for co-locating transmission lines in railroad ROW, or government partnerships or grant programs to capture the value of public health and climate benefits. Transferring some of the initial capital cost and risk of freight rail electrification from freight railroads to utilities and public agencies is critical to achieving freight rail decarbonization.

The CURRENT model developed through this study implements a new risk-based cost-benefit framework for analyzing modern mainline freight rail electrification options. The CURRENT model was used to evaluate various technologies and implementation strategies on two case study corridors. For various scenarios on each case study route, CURRENT produced an estimated distribution of the rate of return based on the uncertainty in various factors and parameters that influence the costs, benefits, and implementation timeline. The case study results demonstrate how different corridors will require different approaches for decarbonization. Corridors with light traffic might work better with BELs, battery tenders, and charging facilities, while longer, traffic-dense corridors will tend to be more suitable for OCS. Even corridors with relatively light traffic densities offer the potential for significant public benefits, but a public policy mechanism is needed to internalize some of the public health and climate emissions benefits to incentivize railroads to electrify such corridors. Additionally, utility partnerships through ROW sharing can significantly improve the feasibility of electrifying a given corridor from the private railroad perspective. Most importantly, all stakeholders need to have a good understanding of the risks and uncertainties other stakeholders face so that a tri-party agreement can be reached to achieve mutual benefits and move freight rail electrification forward.

The case study results from the CURRENT model are only as good as the underlying assumptions and estimates of the future cost distributions of various infrastructure and motive power technologies, plus that of diesel fuel, electricity, and carbon emissions. Sensitivities to these parameters highlight the need for additional research to better understand the modern costs of making signaling and communications systems compatible with OCS, as this is one of the largest capital costs, and the interaction of freight rail electrification with the most common forms of PTC is not well explored in the literature.

The disproportionate savings arising from bridging short OCS gaps at clearance constraints with a last-mile battery, combined with the operational flexibility that a last-mile battery provides, suggests that, for the North American heavy haul freight market, the development of an electric locomotive with appropriate battery capacity should be prioritized over a purely electric locomotive. The case studies exploring intermittent electrification with battery charging in motion along the route reveal that there is substantial opportunity for further research to develop algorithms that optimize the distribution of OCS along a corridor to maintain battery charge while minimizing installation cost and civil construction works necessary to raise clearances. The range of uncertainty in the costs of implementing intermittent electrification, and thus its associated risk, could be substantially reduced through a research program to convert an existing AC traction locomotive to a dual-mode electric platform, develop an EPT, and investigate their combined performance and efficiency on an electrified test track.

15. References

- AECOM (2006). *Design-Build Effectiveness Study - Final Report*. US DOT Federal Highway Administration.
- Alameda Corridor Transportation Authority (2023). [Number of Trains Running on the Corridor](#).
- Anacostia (2024). [NYA - New York & Atlantic Railway](#).
- Arup (2010). *GO Electrification Study Final Report*.
- Association of American Railroads (2022). *AAR Railroad Facts; 2022 Diesel Fuel Costs*.
- Association of American Railroads (2024). *Manuals of Standards and Recommended Practices*. Washington, DC.
- Australian Renewable Energy Agency (2014). *Commercial Readiness Index for Renewable Energy Sectors*. Australian Government.
- Beechey, D., & McKlerie, L. (2021). *Discontinuous Electrification Study: Scottish Borders Railway Newcraighall North Junction to Tweedbank*. Andromeda Engineering.
- Beechey, D., & McKlerie, L. (2021). *Discontinuous Electrification Study: Scottish Borders Railway Newcraighall North Junction to Tweedbank*. Andromeda Engineering.
- Bhargava, B. (1999). *Railway Electrification Systems and Configurations*. *IEEE Power Engineering Society Summer Meeting, Conference Proceedings, 1*. Edmonton, AB, Canada.
- Booze Allen Hamilton (2016). [Argo](#).
- Bureau of Labor Statistics (2024). [CPI Inflation Calculator](#).
- California Air Resources Board (2023). [Locomotive Fact Sheets](#).
- Caltrain & STV Incorporated (1998). *Caltrain Rapid Rail Study*. Peninsula Corridor Joint Powers Board.
- Cambridge Systematics (2012). [Task 8.3: Analysis of Freight Rail Electrification in the SCAG Region](#). Los Angeles: Southern California Association of Governments.
- Clarke, J. (1980). *Railroad Electrification Activity in North America – A Status Report: 1976-1978*. Federal Railroad Administration. Washington, DC: US Department of Transportation Research and Special Programs Administration.
- Cogswell, R. (1994). [Los Angeles Basin Railway Electrification Study](#). *Transportation Research Record* (1480).
- Cook, L. M., & Lawson, L. J. (1981). [Dual-mode Locomotive Systems Engineerings; Volume I: Summary](#). The Garrett Corporation. Washington, DC: US Department of Transportation Federal Railroad Administration.
- Corneil, E. (1977). *Canadian Railway Electrification Study: Phase 1*. *Transportation Research Board Special Report, 180*, 27-34.
- Courtois, C. (1993). [Why the 2*25 kV alternative?](#) *IEEE*.

- Denholm, P., Brown, P., & Cole, W. (2022). [Examining Supply-Side Options to Achieve 100% Clean Electricity by 2035](#). Golden, CO: National Renewable Energy Laboratory.
- Dick, C., Zhao, J., Liu, X., & Kirkpatrick, S. (2021). Quantifying recent trends in Class 1 freight railroad train length and weight by train type. *Transportation Research Record: Journal of the Transportation Research Board*, 2675(12), 890-903.
- DiDomenico, G. C., & Dick, C. T. (2015). Methods of Analyzing and Comparing Energy Efficiency of Passenger Rail Systems. *Transportation Research Record: Journal of the Transportation Research Board*, 2475, 54-62.
- Edison Electric Institute (1970). *Railroad Electrification: A Report to the Railroad Electrification Committee of Edison Electric Institute - Volume 1*. New York: Edison Electric Institute.
- Elbelkasi, M. S., Badran, E. A., & Abedl-Rahman, M. H. (2020). Overview of DC and AC Electric Railway Systems Considering Energy Efficiency Enhancement Methods. *Port-Said Engineering Research Journal*, 24(1), 128-140.
- Energy Information Administration (2022). [U.S. No 2 Diesel Wholesale/Resale Price by Refiners](#).
- Environmental Protection Agency (2023). [Regulations for Emissions from Vehicles and Engines](#).
- Federal Energy Regulatory Commission (2024). [RTOs and ISOs](#).
- Federal Railroad Administration (2023). [Broad Agency Announcement \(BAA\) 2024](#).
- Federal Railroad Administration (2023, December). [FRA Locomotive Emissions Comparison Tool \(LECT\): Emissions Data Documentation](#).
- Fong, C. (2020, June 10). [Third Rail Layout](#).
- Freeman, D. (1980, May 14). Letter addressed to L. S. Crane, Chairman and Executive Officer of the Southern Railway System. Nashville, Tennessee: Tennessee Valley Authority.
- Furtado, F. M. (2013). U.S. and European Freight Railways: The Differences That Matter. *Journal of the Transportation Research Forum*, 52(2), 65-84.
- Garcia, A., Gomez, C., Saa, R., Garcia-Carballeria, F., & Carretero, J. (2013). [Optimizing the process of designing and calculating railway catenary support infrastructure using a high-productivity computational tool](#). *Transportation Research Part C: Emerging Technologies*.
- Goetz, A. R., Jonas, A. E., & Brady, S. (2016). *Innovative Approaches to Improved Intermodal Transportation Infrastructure Funding and Financing through Public-Private Partnerships: A Denver Case Study*. National Center for Intermodal Transportation for Economic Competitiveness.
- Harrison, J. (1981). [An Evaluation of the Costs and Benefits of Railroad Electrification](#). Washington, DC: Federal Railroad Administration.
- Hayes, H. I. (1984). Reducing Catenary Costs by Design. *Transportation Research Record*, 953, 52-57.

- Hestra-Verlag (2000). [*Machines for Catenary Construction and Maintenance*](#). Darmstadt, Germany.
- Hoffrichter, A., Miller, A. R., Hillmansen, S., & Roberts, C. (2012). Well-to-wheel analysis for electric, diesel and hydrogen traction for railways. *Transportation Research Part D*, 17, 28-34.
- Hoffrichter, A., Silmon, J., Schmid, F., Hillmansen, S., & Roberts, C. (2012). [*Feasibility of discontinuous electrification on the Great Western Main Line determined by train simulation*](#). Institution of Mechanical Engineers.
- Iden, M. (2014). Battery Storage of Propulsion Energy for Locomotives. *Proceedings of the 2014 Joint Rail Conference*. ASME.
- Iden, M. (2021). [*Battery Electric Locomotives & Battery Tenders: Operational & Infrastructure Challenges to Widespread Adoption*](#). *Proceedings of the Joint Rail Conference*. American Society of Mechanical Engineers.
- Iden, M. (2021). Battery Electric Locomotives & Battery Tenders: Operational & Infrastructure Challenges to Widespread Adoption. *Proceedings of the 2021 Joint Rail Conference*. ASME.
- Iden, M. (2021). New Locomotives & Technologies: Reducing Operating & Market Failures Through Aggressive Use of Reliability Growth Testing. *Proceedings of the Joint Rail Conference*. ASME.
- Jester, N. (1992). A Status Report of the Electrification Study for the Southern California Regional Rail System. *American Public Transit Association Rail Transit Conference*. Los Angeles, CA.
- Keenor, G. (2021). [*Overhead Line Electrification for Railways, 6th Edition*](#).
- Kidder, A. (1982). *Railroad Electrification Activity; A Summary Report: 1980-1981*. US Department of Transportation Federal Railroad Administration.
- Kim, J. H. et al. (2015, October). Development of 1-MW Inductive Power Transfer System for a High-Speed Train. *IEEE Trans. Ind. Electron*, 62(10), 6242-6250.
- [*Kiruna Electric Locomotives*](#) (n.d.). *Railvolution*, 11(2), pp. 36-46.
- Lisinski, C. (2023, August 11). [*MBTA emphasizes third rail safety after injuries send employee to the hospital*](#). *WBUR*.
- LTK Engineering Services (2012). *Caltrain/California HSR Blended Operations Analysis*. Peninsula Corridor Joint Powers Board.
- Marchinchin, J. (2013, October). Conrail's Electric Dreams. *Trains Magazine*, pp. 40-49.
- McClellan, J. (1978, May 23). Memorandum to File; Subject: TVA Interest in Electrification. Southern Railway.
- Morrison Knudsen Corporation (1992). *Feasibility Study for Electrifying the Caltrain/PCS Railroad: Final Report*. California Department of Transportation.
- National Passenger Railroad Corporation (2021, July). [*Amtrak to Transform Rail Travel with \\$7.3 Billion Investment in State-of-the-Art Equipment*](#).

- NJ Transit (2009). [*NJ Transit ALP45DP Project Status*](#).
- Norfolk Southern Engineering Department (1998). [*1998 Combined Traffic Density*](#).
- Office of Energy Efficiency & Renewable Energy (2012). [*Historical Gasoline Prices, 1929-2011*](#).
- Oliver, J. A., Ross, B. A., Cowal, A. R., & Thompson, J. S. (1971). The Catenary System and Power Supply Facilities of the Muskingum Electric Railroad. *IEEE Transactions on Industry and General Applications*, 7(5), 658-665.
- Project Finance Advisory Ltd. (2016). *Independent Financial Advisor Report to California High-Speed Rail Authority regarding: Peninsula Corridor Funding Plan*. San Francisco: PFAL.
- Rail Transportation and Engineering Center (2016). *Transitioning to a Zero or Near-Zero Emission Line-Haul Freight Rail System in California: Operational and Economic Considerations*. Urbana, IL: California Air Resources Board.
- Railway Industry Association (2019). *RIA Electrification Cost Challenge*. London: UK Railway Industry Association.
- Saa, R. et al. (2012). A High-productivity Computation Tool to Model and Calculate Railway Catenary Support Structures. *Proceedings of the World Congress on Engineering, II*. London, U.K.
- Shin, J. et al. (2014, March). Design and Implementation of Shaped Magnetic-Resonance-Based Wireless Power Transfer System for Roadway-Powered Moving Electric Vehicles. *IEEE Trans. Ind. Electron*, 61(3), 1179-1192.
- Southern California Regional Rail Authority (1992). *Southern California Accelerated Rail Electrification Program*. Los Angeles, CA: SCRRA.
- Spenny, C., & Mott, G. (1983). *A Model for Evaluating the Costs and Benefits of Railroad Electrification*. Cambridge, MA: Transportation Systems Center.
- SPSmiler (2005). [*Arcing Pickup Shoe*](#).
- Tennessee Valley Authority (1980, June 6). Railway Electrification Demonstration Project (REDP) Presentation to Seaboard Coastline Industries (L&N) and Southern Railway System. Nashville, TN.
- The Appraisal Institute (2006). *Dictionary of Real Estate Appraisal; 3rd Edition*.
- US Department of Transportation (2023, December). [*Cost-benefit Analysis Guidance for Discretionary Grant Programs*](#).
- US Department of Transportation (2023, December). [*Cost-benefit Analysis Guidance for Discretionary Programs*](#).
- US Environmental Protection Agency (2009). [*Emission Factors for Locomotives*](#).
- Wales, P., & Wilson, B. (2023). A Modern Approach to Electrification for Heavy Haul Railways. *Proceedings of the 12th International Heavy Haul Association Conference*. Rio de Janeiro, Brazil: International Heavy Haul Association.

- Walthall, R. (2019). [*Rail electrification's potential for emissions abatement in the freight industry: A case study of a transcontinental rail corridor*](#). The University of Texas at Austin.
- Weiss, W. D., Hayes, I. H., & Shaw, P. L. (1983). Comparative Catenary Costs - European and U.S. Main Line Railroad Electrification. *Transportation Research Record*, 939, 44-48.
- Winter, J., Mayer, S., Kaimer, S., Seitz, P., Pagenkopf, J., & Streit, S. (2013). [*Inductive power supply for heavy rail vehicles*](#). *3rd International Electric Drives Production Conference (EDPC)*, (pp. 1-9). Nuremberg, Germany.
- Worrell, C. (2022, December 19). [*First Look: Amtrak Airo*](#).
- Xu, X. (2022). *Wireless power transfer for railway applications*. University of North Carolina at Charlotte.

Abbreviations and Acronyms

ACRONYM	DEFINITION
AAR	Association of American Railroads
AC	Alternating Current
APTA	American Public Transportation Association
APV	Auxiliary Powered Vehicle
ATSF	Atchison, Topeka, and Santa Fe Railway
BCR	Benefit-cost Ratio
BEL	Battery-electric Locomotive
BEMU	Battery Electric Multi Unit
BNSF	Burlington Northern and Santa Fe Railway
BSFC	Brake Specific Fuel Consumption
BT	Battery Tender
CAHSR	California High-Speed Rail Authority
CAPEX	Capital Expenses
CARB	California Air Resources Board
CBOSS	Communications-based Overlay Signal System
cdf	Cumulative density function
CNO&TP	Cincinnati, New Orleans and Texas Pacific Railway
CO	carbon monoxide
CO ₂	Carbon dioxide
CO _{2e}	CO ₂ -equivalents
CRI	Commercial Readiness Index
CURRENT	Costs, Uncertainties, & Risks of Rail Electrification with New Technologies
DBFOM	Design-Build-Finance-Operate-Maintain
DBOM	Design-Build-Operate-Maintain
DC	Direct Current
DFT	Diesel Fuel Tender

ACRONYM	DEFINITION
DML	Dual-mode Locomotive
DOT	Department of Transportation
DP	Distributed Power
EI	Edison Electric Institute
EIA	Energy Information Administration
eGRID	Emissions & Generation Resource Integrated Database
EMD	Electro-Motive Division of General Motors (later Electro-Motive Diesel)
EMU	Electric Multiple Unit
EPA	Environmental Protection Agency
EPT	Electric Power Tender
FERC	Federal Energy Regulatory Commission
FRA	Federal Railroad Administration
GE	General Electric
GWML	Great Western Mainline
HEP	Head-end Power
H ₂ FCL	Hydrogen Fuel Cell Locomotives
IEP	Intercity Express Programme
IPV	Incremental Present Value
ISO	Independent System Operator
L&N	Louisville and Nashville Railway
LSM	Linear Synchronous Motor
MGT	Million Gross Ton-miles per mile
MROW	Midwest Reliability Organization – West
MSRP	Manual of Standards & Recommended Practices
NEC	Northwest Corridor
NJT	NJ Transit
NREL	National Renewable Energy Laboratory
NO _x	Oxides of nitrogen

ACRONYM	DEFINITION
OCS	Overhead Contact System
OEM	Original Equipment Manufacturer
pdf	Probability density function
PM _{2.5}	Fine Particulate Matter
PTC	Positive Train Control
REAM	Railroad Electrification Assessment Model
REDP	Railroad Electrification Demonstration Project
REMC	Railroad Electrification Management Corporation
RGT	Reliability Growth Testing
ROI	Return on Investment
ROW	Right-of-Way
RTO	Regional Transmission Organization
SCE	Southern California Edison
SCAB	South Coast Air Basin
SCRRA	Southern California Regional Rail Authority
SOC	State of Charge
SOFC	Solid Oxide Fuel Cell
SO ₂	Sulfur Dioxide
SO _x	Oxides of Sulfur
SP	Southern Pacific Railroad
SR	Southern Railway
SWOT	Strengths, Weaknesses, Opportunities, and Threats
TRL	Technology Readiness Level
TSC	Transportation Systems Center
TTC	Transportation Technology Center
TVA	Tennessee Valley Authority
UP	Union Pacific Railroad
US DOT	United States Department of Transportation

ACRONYM**DEFINITION**

VOCs

Volatile Organic Compounds

WESS

Wayside Energy Storage System

WP

Western Pacific Railroad